

HBT DIGITAL PHASE FREQUENCY DETECTOR 10 - 1300MHz

Typical Applications

The HMC3716LPE is ideal for:

- Point-to-Point Radios
- Satellite Communication Systems
- Military Applications
- Sonet Clock Generation

Features

- Ultra Low SSB Phase Noise Floor:
-153dBc/Hz @ 10kHz offset @ 100MHz
- Integrated Output Resistors
- Improved Input Sensitivity
- Lock Detect and Invert Functionality
- 24-Pin 4 x 4mm SMT Package

General Description

The HMC3716LP4E is a digital phase frequency detector which operates from 10 to 1300MHz. It is intended for use in low phase noise synthesizer applications.

The combination of high frequency of operation along with its ultra low phase noise floor make possible synthesizers with wide loop bandwidth and low N resulting in fast switching and very low phase noise. When used in conjunction with a differential loop amplifier, the HMC3716LP4E generates output voltages that can be used to phase lock a VCO to a reference oscillator.

The device is packaged in a 24-pin, 4 x 4mm leadless QFN surface mount package with an exposed ground paddle for improved RF and thermal performance.

Functional Diagram

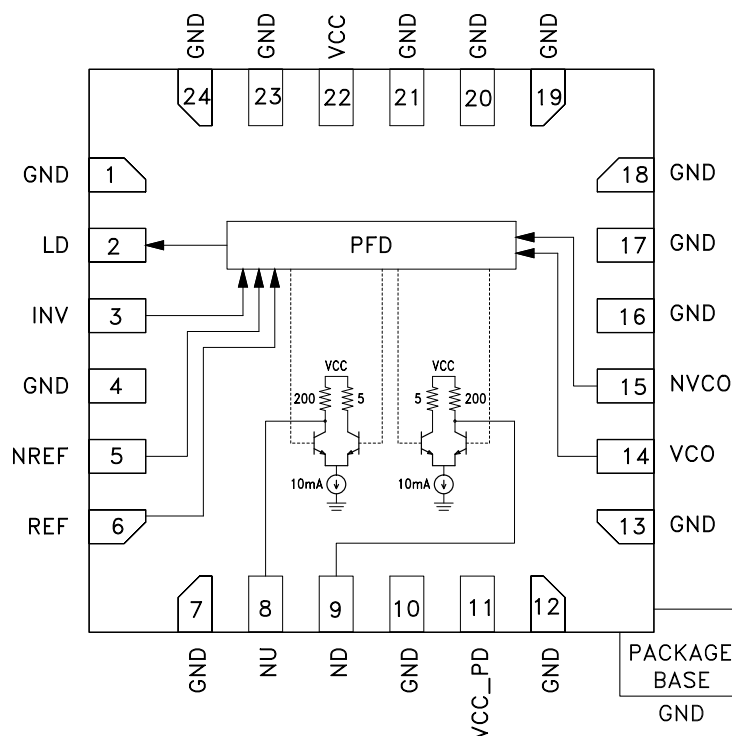

HBT DIGITAL PHASE FREQUENCY DETECTOR 10 - 1300MHz

Electrical Specifications, $T_A = +25^\circ\text{C}$, $V_{CC} = 5.0\text{V}$

Parameter	Conditions	Min.	Typ.	Max.	Units
REF / VCO Input Frequency	Min must be Square Wave Max can be Sine or Square Wave	10	100	1300	MHz
Input Power Range		-10	5	+5	dBm
Output Voltage Swing (NU / ND)	Driving High-Z Load / Op-Amp		2		V _{p-p}
PFD Gain	Gain = $V_{pp} / 2\pi$ Rad		0.32		V / Rad
SSB Phase Noise [1]	@ 10kHz Offset with 100 MHz REF / VCO @ +5 dBm		-153		dBc/Hz
Logic Input Voltage (INV)	CMOS / TTL Logic Low CMOS / TTL Logic High	0.0 1.8		1.1 5.0	V
Lock Detect Output Voltage	Filtering & 1k Ω Pull-Up Required CMOS / TTL Logic Low = Unlocked MOS / TTL Logic High = Locked	0.0 2.7		0.5 5.0	V
Lock Detect Sink Current			5		mA
Supply Voltage (V _{CC})		4.75	5.00	5.25	V
Supply Current (I _{CC})	V _{CC} = 5.0V		115		mA
Temperature Range		-40		+85	$^\circ\text{C}$

[1] Square wave input achieves best phase noise at lower REF/VCO frequencies (see comparison plots on preceding page)

**HBT DIGITAL PHASE FREQUENCY DETECTOR
10 - 1300MHz**

**Phase Noise Floor, Vcc = 4.75V
REF = 100MHz Sine Wave**



**Phase Noise Floor, Vcc = 4.75V
REF = 100MHz Square Wave**



**Phase Noise Floor, Vcc = 5.00V
REF = 100MHz Sine Wave**



**Phase Noise Floor, Vcc = 5.00V
REF = 100MHz Square Wave**



**Phase Noise Floor, Vcc = 5.25V
REF = 100MHz Sine Wave**

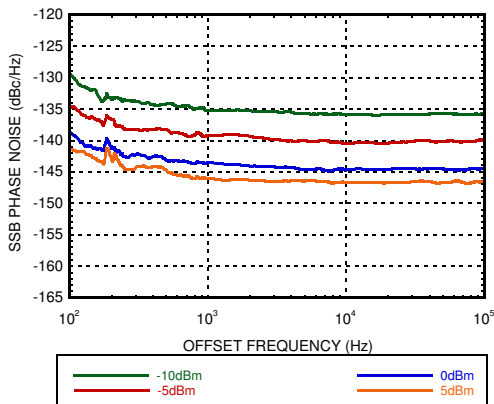

**Phase Noise Floor, Vcc = 5.25V
REF = 100MHz Square Wave**

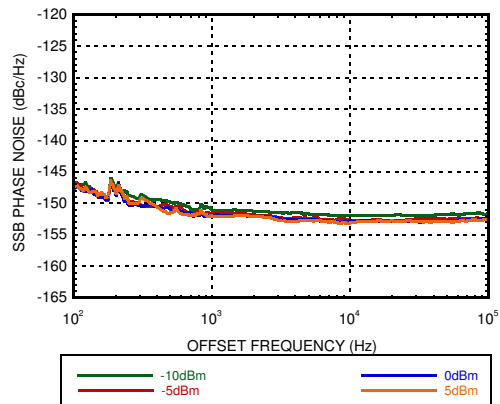

**HBT DIGITAL PHASE FREQUENCY DETECTOR
10 - 1300MHz**

**Phase Noise Floor, Vcc = 4.75V
REF = 1000MHz Sine Wave**

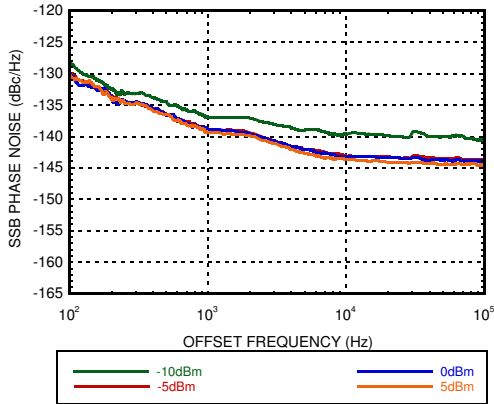

**Phase Noise Floor, Vcc = 4.75V
REF = 10MHz Square Wave**

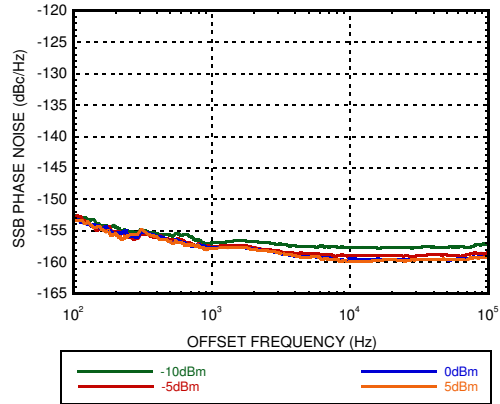

**Phase Noise Floor, Vcc = 5.00V
REF = 1000MHz Sine Wave**

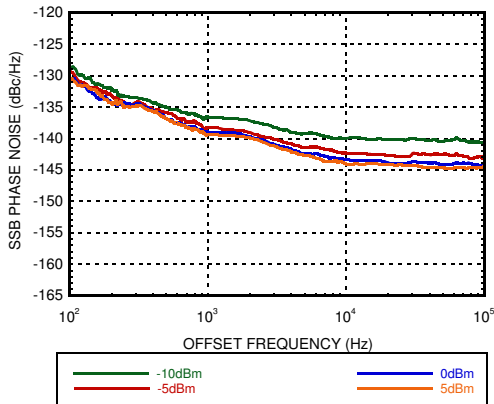

**Phase Noise Floor, Vcc = 5.00V
REF = 10MHz Square Wave**

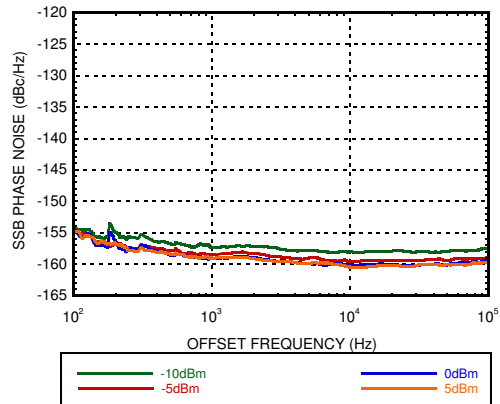

**Phase Noise Floor, Vcc = 5.25V
REF = 1000MHz Sine Wave**

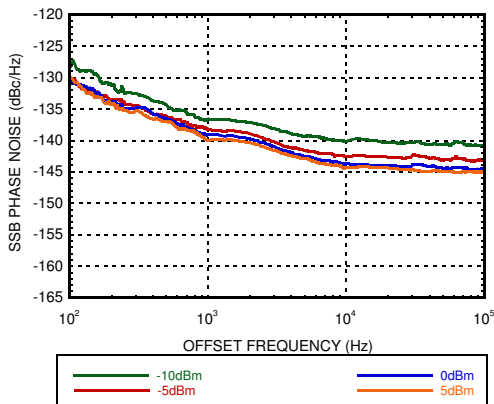

**Phase Noise Floor, Vcc = 5.25V
REF = 10MHz Square Wave**

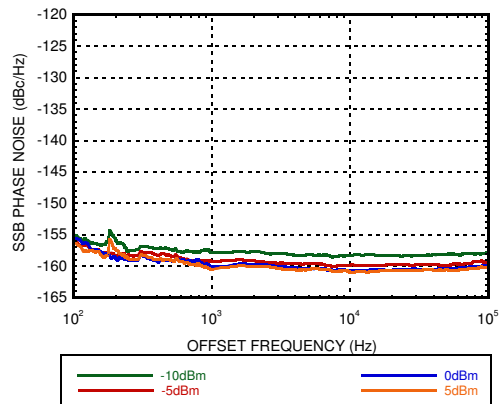

**HBT DIGITAL PHASE FREQUENCY DETECTOR
10 - 1300MHz**

**Phase Noise Floor, Vcc = 5.00V
REF = 100MHz Sine Wave**



**Phase Noise Floor, Vcc = 5.00V
REF = 100MHz Square Wave**

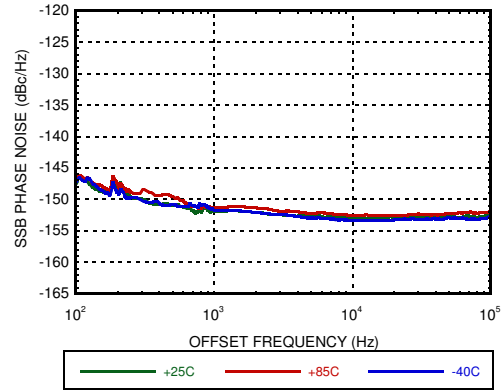

**Phase Noise Floor, Vcc = 5.00V
REF = 1000MHz Sine Wave**



**Phase Noise Floor, Vcc = 5.00V
REF = 10MHz Square Wave**

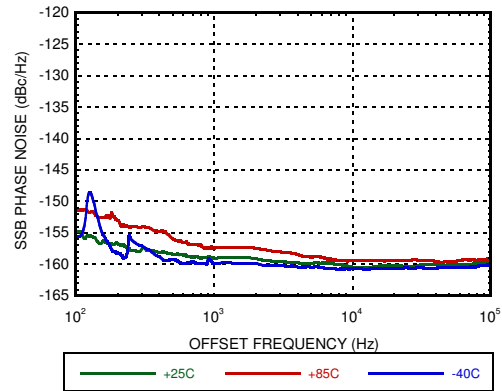

**Phase Noise Floor, Vcc = 5.00V
REF = 10 & 1000MHz, ≥10kHz offset**

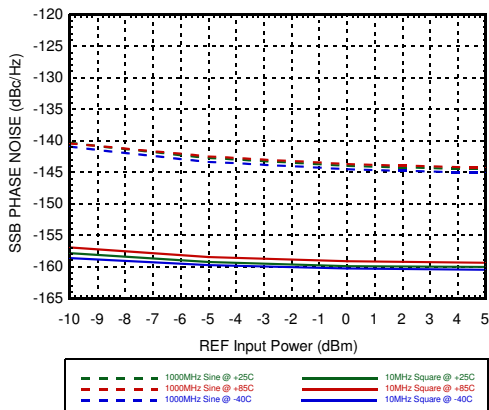

**Phase Noise Floor, Vcc = 5.00V
REF = 100MHz, ≥10kHz offset**

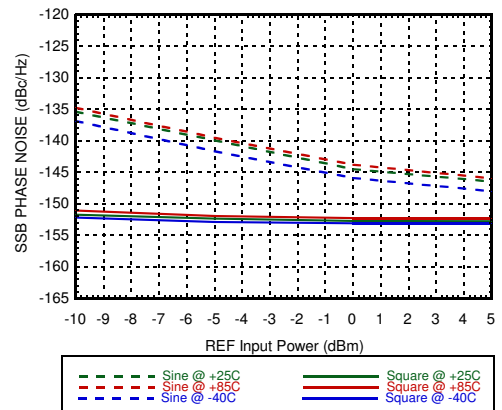

HBT DIGITAL PHASE FREQUENCY DETECTOR 10 - 1300MHz

**Typical PLL Performance, $V_{cc} = 5.00V$
REF = 100MHz Square Wave
VCO = 10GHz, $N = 100$, $T = +25C$**



**PFD Outputs ND, NU, LD, $V_{cc} = 5.00V$
Forced PFD Difference $\approx 11Hz$
High-Z Scope, $BW = 20MHz$, $T = +25C$**

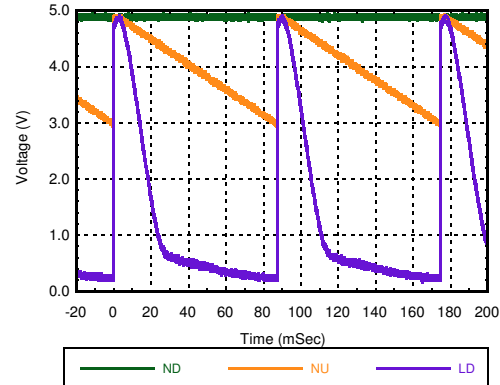

Typical Supply Current vs. V_{cc}

V_{cc} (Vdc)	I_{cc} (mA)
4.75	107
5.00	115
5.25	123

Typical ND & NU Voltages, $V_{cc} = +5V$

Symbol	Characteristics	+25C			Units
		Min.	Typ.	Max.	
V_{oh}	Output High Voltage	4.9	5.0	5.1	V
V_{ol}	Output Low Voltage	2.9	3	3.1	V

Reliability Information

Junction Temperature To Maintain 1 Million Hour MTTF	135 °C
Nominal Junction Temperature ($T = +85$ °C)	99.3 °C
Thermal Resistance (junction to ground paddle)	24.9°C/W
Operating Temperature	-40 to +85 °C

Absolute Maximum Ratings

RF Input ($V_{cc} = +5V$)	+13 dBm
Supply Voltage (V_{cc})	+5.5V
Logic Inputs (INV)	-0.5 to (0.5V + V_{cc})
PFD Outputs (ND, NU)	2.5 to (0.5V + V_{cc})
Storage Temperature	-65 to +150 °C
ESD Sensitivity (HBM)	Class 1B
ESD Sensitivity (CDM)	Class C2



**ELECTROSTATIC SENSITIVE DEVICE
OBSERVE HANDLING PRECAUTIONS**

Notes:

- All data shown is typical and actual performance may vary depending upon implementation.
- Phase Noise data taken utilizing 2-unit PLL cancellation method with $VCO \geq 2400MHz$ and healthy power level.
- Only one PFD output will be active with a forced frequency difference, depending upon which input frequency is higher.
- Without oscilloscope bandwidth limiting, there will be narrow pulses on NU, ND, & LD, at the input frequencies. These pulses may create spectral content, which is normally suppressed with the loop filter and lock detect filter.

HBT DIGITAL PHASE FREQUENCY DETECTOR 10 - 1300MHz

Pin Descriptions

Pin Number	Function	Description	Interface Schematic
1, 4, 7, 10, 12, 13, 16 - 21, 23, 24, Paddle	GND	Package bottom has an exposed metal paddle that must be connected to RF/DC ground.	
2	LD	Lock Detect Output Open collector pulsed output. Requires external 1kΩ Pullup to Vcc and filtering. Average "LOW" = UNLOCKED Average "HIGH" = LOCKED	
3	INV	PFD INVERT Function to swap REF & VCO CMOS / TTL compatible Logic "LOW" = NORMAL Logic "HIGH" = INVERT	
11	Vcc_PD	Supply Voltage, +5.00V	
22	Vcc		
8	NU	Up Output Do not load output below 2.5V or damage can occur.	
9	ND	Down Output Do not load output below 2.5V or damage can occur.	
5	NREF	Differential REF Inputs Pins are DC coupled, External DC blocks required	
6	REF		
14	VCO	Differential VCO Inputs Pins are DC coupled, External DC blocks required	
15	NVCO		

HBT DIGITAL PHASE FREQUENCY DETECTOR

10 - 1300MHz

PFD Functionality

The phase frequency detector functionality of the HMC3716LP4E is such that it compares the rising edge the two input signals (REF / VCO). This information is then used to pulse the ND and NU outputs depending upon which input signal is greater in frequency.

Under normal operation the ND pin will be active when VCO frequency is greater than the REF frequency; NU would remain constant. Conversely, when the VCO frequency is lower than the REF frequency, then NU would be active and ND would remain constant. Here, the term “active” means that the output will on average, vary between 3 - 5V, and the term “remain constant” means that the output will remain at approximately 5V.

INVERT Functionality

The INV pin effectively swaps the REF and VCO input signals, such that the NU and ND pin responses are swapped. This has the advantage of easily correcting a layout issue if the loop filter op-amp inputs were swapped.

A logic “LOW” on this pin will configure the device for normal operation, and a logic “HIGH” cause the input signals to swap. The evaluation board has a 10kΩ resistor pull up resistor to 5V. A jumper must be installed connecting the INV pin to ground for normal operation.

Lock Detect Functionality

The LD pin is an open collector pulsed output transistor. It requires an external 1k pull up resistor to Vcc (5V), as well as a simple RC filter.

Since the pin will produce very narrow pulses at each zero crossing of the REF and VCO input signals, filtering is necessary to create an average voltage which can be used to drive an LED or system input logic. When the device is “LOCKED”, that transistor will effectively be “OFF”, and the filtered output voltage will be “HIGH”.

Below is an example of an RC filter for the lock detect pin. The value of resistor “R” should be greater than 100Ω to limit any surge current from flowing when the output transistor is “ON”. The value of capacitor “C” should be selected such that the filter cutoff is much less than the REF frequency, but not excessively large (slow) that it will inhibit detection of lock status.

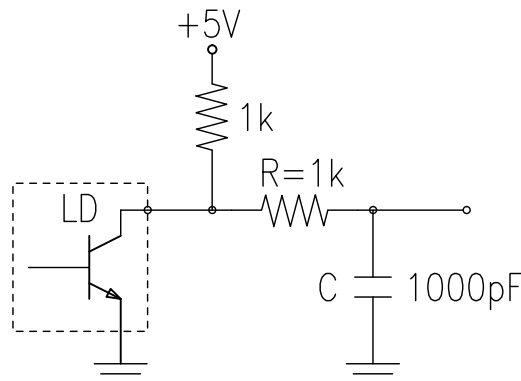

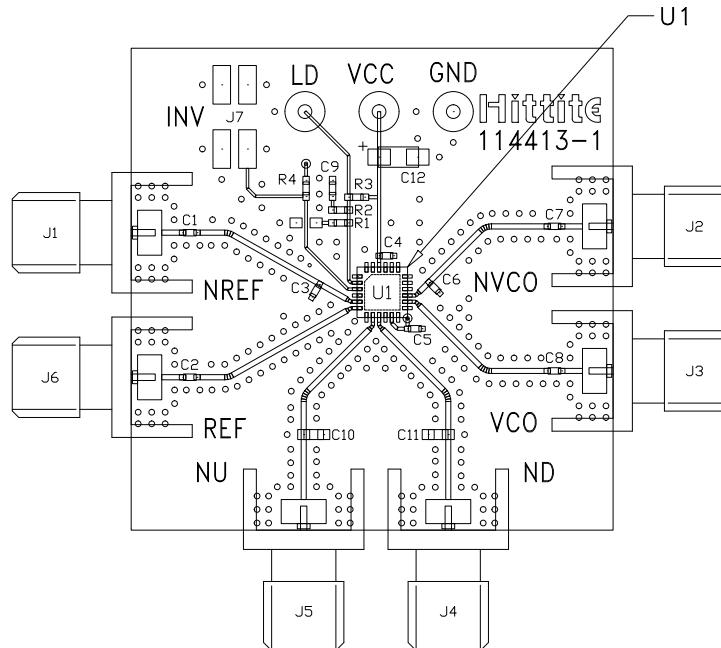
**HBT DIGITAL PHASE FREQUENCY DETECTOR
10 - 1300MHz**
Evaluation PCB

The circuit board used in the application should use RF circuit design techniques. Signal lines should have 50Ω impedance while the package ground leads and backside ground paddle should be connected directly to the ground plane similar to that shown. A sufficient number of via holes should be used to connect the top and bottom ground planes.

List of Materials for Evaluation PCB EV1HMC3716LP4 [1]

Item	Description
PCB [2]	114413 Eval Board
U1	HMC3716LP4E, PFD w/ Lock Detect and Invert functions
J1 - J6	PCB Mount SMA RF Connector
J7	2mm, 4-pin DC Header (cut to fit)
Qty 1	2mm Shunt/Jumper
C1 - C8	100pF Ceramic Capacitor, 5%, 50V, 0402
C12	4.7μF, Tantalum Capacitor, 16V, 20%, 3216
R3	1kΩ Resistor, 5%, 1/10W, 0402
R4	10kΩ Resistor, 5%, 1/10W, 0402
R1, R2, C9 - C11	Do Not Install

[1] Reference this part number when ordering complete PCB

[2] Circuit Board Material: Rogers 4350

HBT DIGITAL PHASE FREQUENCY DETECTOR 10 - 1300MHz

Outline Drawing

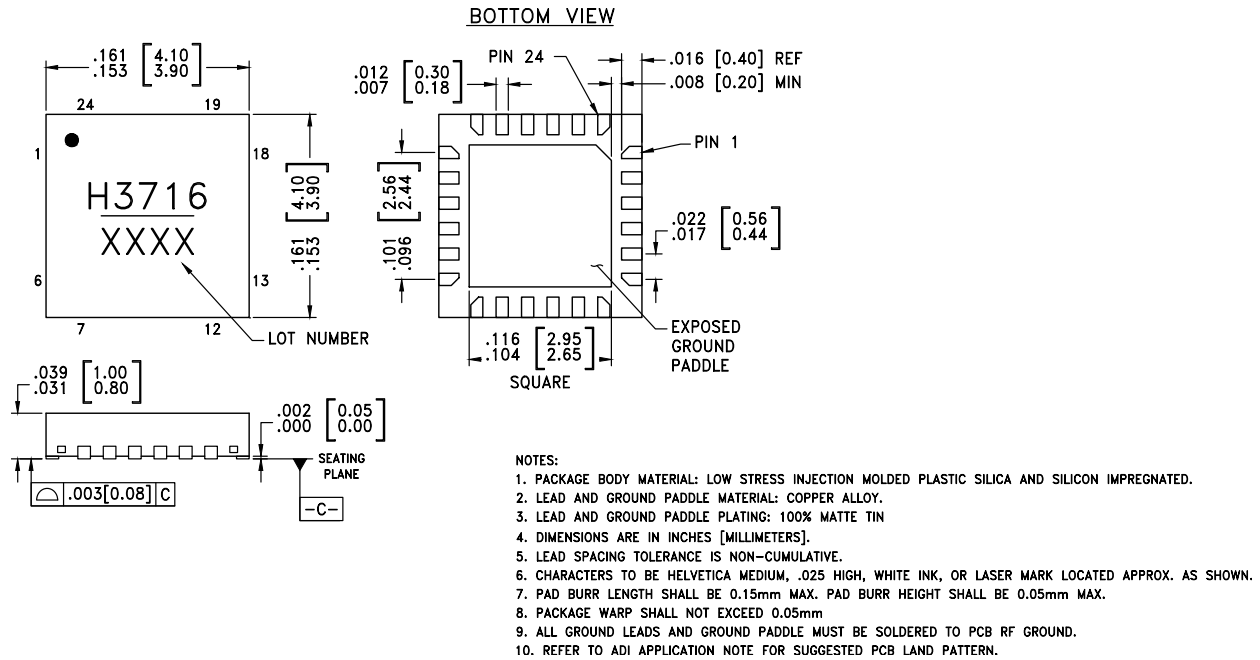

Package Information

Part Number	Package Body Material	Lead Finish	MSL Rating	Package Marking ^[2]
HMC3716LP4E	RoHS-compliant Low Stress Injection Molded Plastic	100% matte Sn	MSL1 ^[1]	H3716 XXXX

[1] Max peak reflow temperature of 260 °C

[2] 4-Digit lot number XXXX