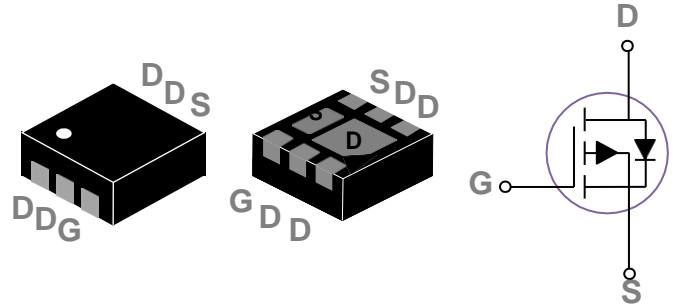


These P-Channel enhancement mode power field effect transistors are using trench DMOS technology. This advanced technology has been especially tailored to minimize on-state resistance, provide superior switching performance, and withstand high energy pulse in the avalanche and commutation mode. These devices are well suited for high efficiency fast switching applications.

BVDSS	RDSON	ID
-15V	25mΩ	-8.5A

## DFN2x2-6L Pin Configuration



## Features

- -15V, -8.5A,  $R_{DS(ON)} = 25m\Omega @ V_{GS} = -4.5V$
- Improved  $dv/dt$  capability
- Fast switching
- Green Device Available
- Suit for -1.8V Gate Drive Applications
- Marking : 1A

## Applications

- Notebook
- Load Switch
- Battery Protection
- Hand-held Instruments

## Absolute Maximum Ratings $T_C=25^\circ C$ unless otherwise noted

Symbol	Parameter	Rating	Units
$V_{DS}$	Drain-Source Voltage	-15	V
$V_{GS}$	Gate-Source Voltage	$\pm 12$	V
$I_D$	Drain Current – Continuous ( $T_C=25^\circ C$ )	-8.5	A
	Drain Current – Continuous ( $T_C=100^\circ C$ )	-5.4	A
$I_{DM}$	Drain Current – Pulsed <sup>1</sup>	-34	A
$P_D$	Power Dissipation ( $T_C=25^\circ C$ )	3.3	W
	Power Dissipation – Derate above $25^\circ C$	0.026	W/ $^\circ C$
$T_{STG}$	Storage Temperature Range	-55 to 150	$^\circ C$
$T_J$	Operating Junction Temperature Range	-55 to 150	$^\circ C$

## Thermal Characteristics

Symbol	Parameter	Typ.	Max.	Unit
$R_{\theta JA}$	Thermal Resistance Junction to ambient	---	62	$^\circ C/W$
$R_{\theta JC}$	Thermal Resistance Junction to Case	---	38	$^\circ C/W$

## Electrical Characteristics (T<sub>J</sub>=25 °C, unless otherwise noted)

### Off Characteristics

Symbol	Parameter	Conditions	Min.	Typ.	Max.	Unit
BV <sub>DSS</sub>	Drain-Source Breakdown Voltage	V <sub>GS</sub> =0V , I <sub>D</sub> =-250uA		-15	---	V
ΔBV <sub>DSS</sub> /ΔT <sub>J</sub>	BV <sub>DSS</sub> Temperature Coefficient	Reference to 25°C , I <sub>D</sub> =-1mA	---	-0.02	---	V/°C
I <sub>DSS</sub>	Drain-Source Leakage Current	V <sub>DS</sub> =-13V , V <sub>GS</sub> =0V , T <sub>J</sub> =25°C	---	---	-1	uA
		V <sub>DS</sub> =-13V , V <sub>GS</sub> =0V , T <sub>J</sub> =125°C	---	---	-10	uA
I <sub>GSS</sub>	Gate-Source Leakage Current	V <sub>GS</sub> =±10V , V <sub>DS</sub> =0V	---	---	±100	nA

### On Characteristics

R <sub>DS(ON)</sub>	Static Drain-Source On-Resistance	V <sub>GS</sub> =-4.5V , I <sub>D</sub> =-4A	---	23	25	mΩ
		V <sub>GS</sub> =-2.5V , I <sub>D</sub> =-3A	---	27	37	
		V <sub>GS</sub> =-1.8V , I <sub>D</sub> =-2A	---	33	45	
V <sub>GS(th)</sub>	Gate Threshold Voltage	V <sub>GS</sub> =V <sub>DS</sub> , I <sub>D</sub> =-250uA	-0.3	-0.6	-1	V
ΔV <sub>GS(th)</sub>	V <sub>GS(th)</sub> Temperature Coefficient		---	2	---	mV/°C
g <sub>fs</sub>	Forward Transconductance	V <sub>DS</sub> =-10V , I <sub>S</sub> =-3A	---	8.4	---	S

### Dynamic and switching Characteristics

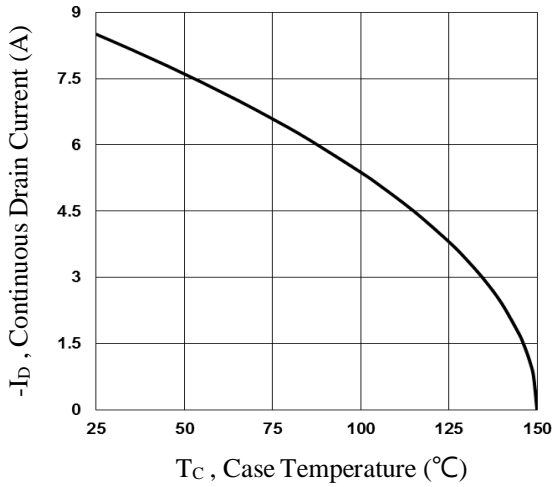
Q <sub>g</sub>	Total Gate Charge <sup>2, 3</sup>	V <sub>DS</sub> =-10V , V <sub>GS</sub> =-4.5V , I <sub>D</sub> =-4A	---	16.1	25	nC
Q <sub>gs</sub>	Gate-Source Charge <sup>2, 3</sup>		---	1.8	3	
Q <sub>gd</sub>	Gate-Drain Charge <sup>2, 3</sup>		---	3.8	7	
T <sub>d(on)</sub>	Turn-On Delay Time <sup>2, 3</sup>	V <sub>DD</sub> =-10V , V <sub>GS</sub> =-4.5V , R <sub>G</sub> =25Ω I <sub>D</sub> =-1A	---	8.2	16	nS
T <sub>r</sub>	Rise Time <sup>2, 3</sup>		---	30	57	
T <sub>d(off)</sub>	Turn-Off Delay Time <sup>2, 3</sup>		---	71.1	135	
T <sub>f</sub>	Fall Time <sup>2, 3</sup>		---	19.8	38	
C <sub>iss</sub>	Input Capacitance	V <sub>DS</sub> =-15V , V <sub>GS</sub> =0V , F=1MHz	---	1440	2100	pF
C <sub>oss</sub>	Output Capacitance		---	155	230	
C <sub>rss</sub>	Reverse Transfer Capacitance		---	115	170	

### Drain-Source Diode Characteristics and Maximum Ratings

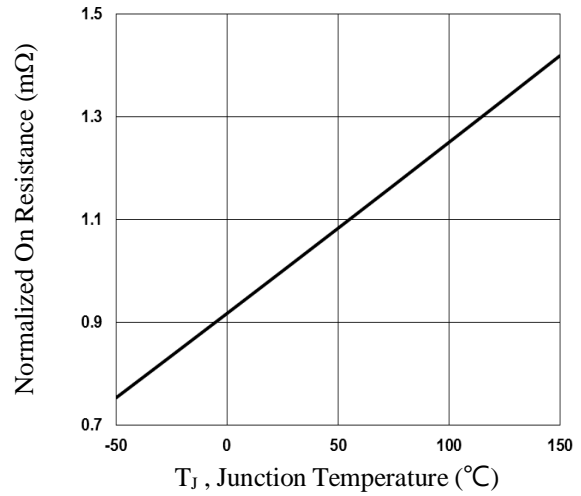
Symbol	Parameter	Conditions	Min.	Typ.	Max.	Unit
I <sub>S</sub>	Continuous Source Current	V <sub>G</sub> =V <sub>D</sub> =0V , Force Current	---	---	-8.5	A
I <sub>SM</sub>	Pulsed Source Current		---	---	-17	A
V <sub>SD</sub>	Diode Forward Voltage	V <sub>GS</sub> =0V , I <sub>S</sub> =-1A , T <sub>J</sub> =25°C	---	---	-1	V

Note :

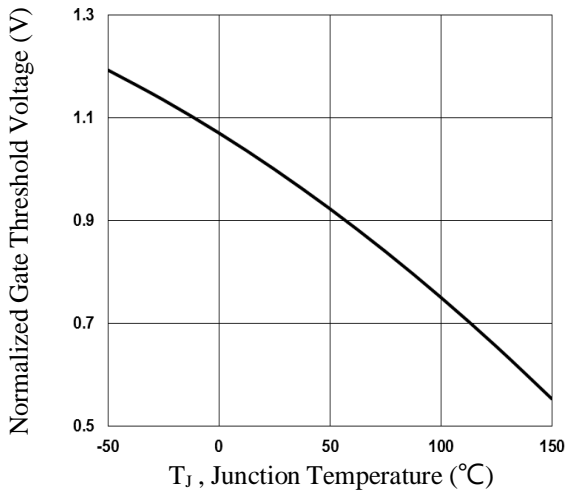
1. Repetitive Rating : Pulsed width limited by maximum junction temperature.
2. The data tested by pulsed , pulse width ≤ 300us , duty cycle ≤ 2%.
3. Essentially independent of operating temperature.



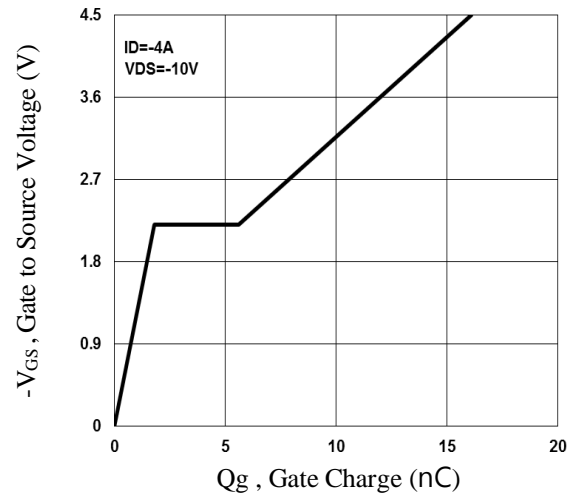
**Fig.1 Continuous Drain Current vs.  $T_c$**



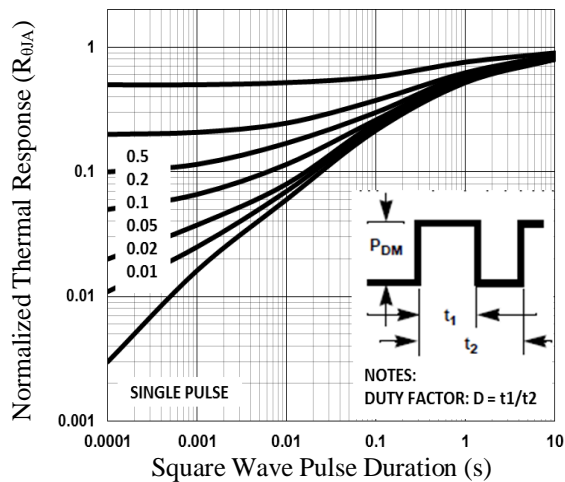
**Fig.2 Normalized  $R_{DS(on)}$  vs.  $T_j$**



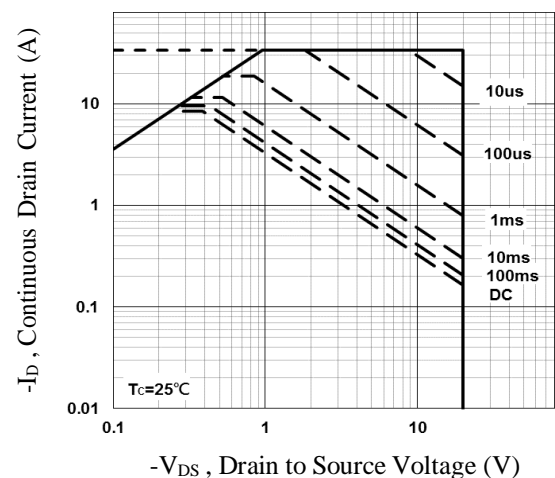
**Fig.3 Normalized  $V_{th}$  vs.  $T_j$**



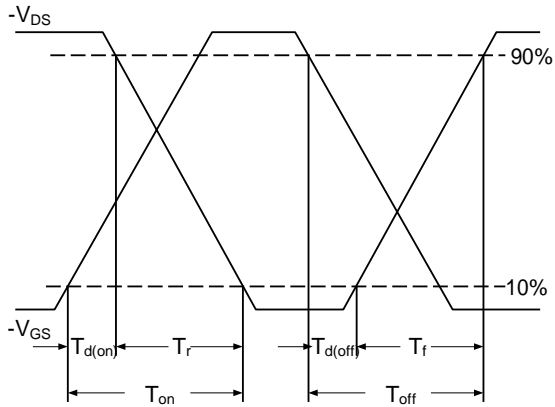
**Fig.4 Gate Charge Waveform**



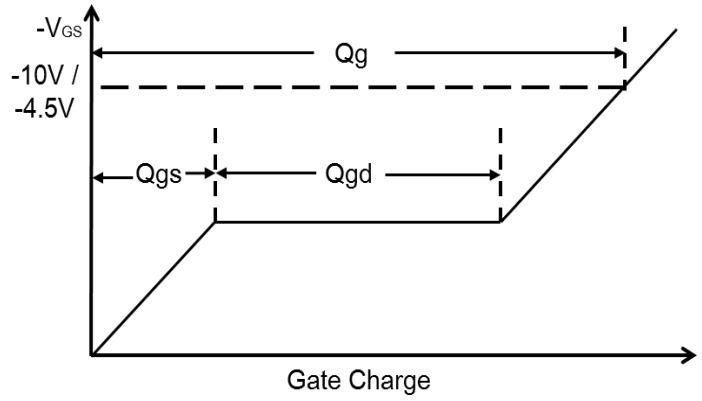
**Fig.5 Normalized Transient Impedance**



**Fig.6 Maximum Safe Operation Area**

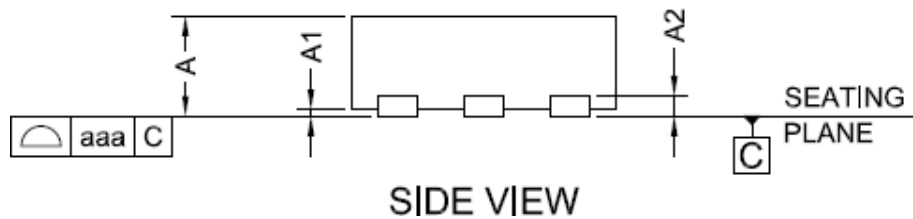
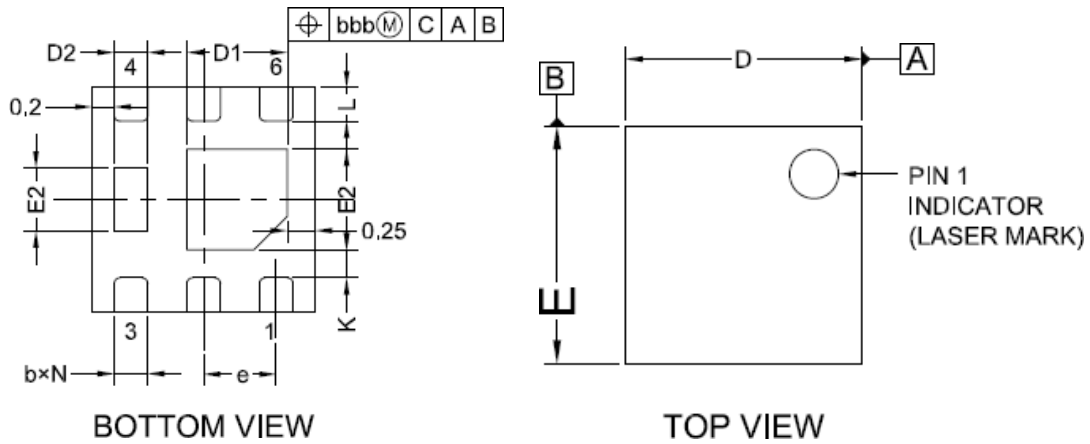


**Fig.7 Switching Time Waveform**



**Fig.8 Gate Charge Waveform**

## DFN2x2-6L PACKAGE INFORMATION



COMMON DIMENSIONS  
(UNITS OF MEASURE=MILLIMETER)

SYMBOL	MIN	TYP	MAX
A	0.50	0.55	0.60
A1	0.00	0.02	0.05
A2	0.152REF.		
b	0.25	0.30	0.35
D	1.95	2.00	2.05
D1	0.80	0.90	1.00
D2	0.25	0.30	0.35
E	1.95	2.00	2.05
E1	0.80	0.90	1.00
E2	0.46	0.56	0.66
e	0.65BSC		
L	0.25	0.30	0.35
J	0.40BSC		
K	0.20MIN		
N	6		
aaa	0.08		
bbb	0.10		