

### GENERAL DESCRIPTION

The SGM4518 is an 8-channel, TTL/CMOS compatible analog multiplexer. It operates from +3.2V to +36V single power supply or  $\pm 3.2V$  to  $\pm 18V$  dual power supplies.

The SGM4518 features high voltage, low on-resistance and low distortion. The high performances make it very suitable for multiple applications, such as battery-operated equipment, audio and video signal routing, etc.

TTL/CMOS logic compatibility can be guaranteed when using a single +5V or dual  $\pm 5V$  power supplies because the logic thresholds of all digital inputs are between 0.8V and 2.4V.

The SGM4518 is available in Green SOIC-16, SSOP-16, TSSOP-16 and TQFN-3 $\times$ 3-16L packages. It operates over an operating temperature range of -40°C to +125°C.

### FEATURES

- **Single Supply Voltage Range: +3.2V to +36V**
- **Dual-Supply Voltage Range:  $\pm 3.2V$  to  $\pm 18V$**
- **High Off-Isolation: -85dB ( $R_L = 50\Omega$ ,  $f = 1MHz$ )**
- **On-Resistance:**
  - 22 $\Omega$  (TYP) with Single 36V Supply**
- **Low On-Resistance Flatness**
- **Low Off-Leakage Current: 0.01 $\mu A$  (TYP) at +25°C**
- **Low On-Leakage Current: 0.01 $\mu A$  (TYP) at +25°C**
- **Low Crosstalk: -83dB (TYP) ( $R_L = 50\Omega$ ,  $f = 1MHz$ )**
- **Low Distortion: 0.001% ( $R_L = 600\Omega$ ,  $f = 1kHz$ )**
- **Rail-to-Rail Input and Output Operation**
- **TTL/CMOS-Logic Compatible**
- **-40°C to +125°C Operating Temperature Range**
- **Available in Green SOIC-16, SSOP-16, TSSOP-16 and TQFN-3 $\times$ 3-16L Packages**

### APPLICATIONS

Portable Equipment  
Sample-and-Hold Circuits  
Battery-Powered Systems  
Audio and Video Signal Routing

**PACKAGE/ORDERING INFORMATION**

MODEL	PACKAGE DESCRIPTION	SPECIFIED TEMPERATURE RANGE	ORDERING NUMBER	PACKAGE MARKING	PACKING OPTION
SGM4518	SOIC-16	-40°C to +125°C	SGM4518XS16G/TR	SGM4518XS16 XXXXX	Tape and Reel, 2500
	SSOP-16	-40°C to +125°C	SGM4518XQS16G/TR	SGM4518 XQS16 XXXXX	Tape and Reel, 4000
	TSSOP-16	-40°C to +125°C	SGM4518XTS16G/TR	SGM4518 XTS16 XXXXX	Tape and Reel, 4000
	TQFN-3x3-16L	-40°C to +125°C	SGM4518XTQ16G/TR	4518TQ XXXXX	Tape and Reel, 4000

**MARKING INFORMATION**

NOTE: XXXXX = Date Code, Trace Code and Vendor Code.

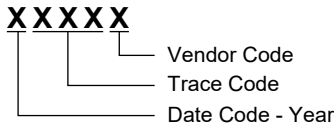

Green (RoHS & HSF): SG Micro Corp defines "Green" to mean Pb-Free (RoHS compatible) and free of halogen substances. If you have additional comments or questions, please contact your SGMICRO representative directly.

**ABSOLUTE MAXIMUM RATINGS**

Voltages Referenced to V<sub>EE</sub>

- V<sub>CC</sub> ..... -0.3V to 40V
- GND ..... -0.3V to 40V
- Analog Switch I/O Voltage, V<sub>IS</sub> ..... (V<sub>EE</sub> - 0.3V) to (V<sub>CC</sub> + 0.3V)
- Digital Control Voltage ..... (GND - 0.3V) to (V<sub>CC</sub> + 0.3V)
- Continuous Current into Analog Switch I/O, X<sub>-</sub><sup>(1)</sup> or X<sub>+</sub> ..... ±40mA
- Junction Temperature ..... +150°C
- Storage Temperature Range ..... -65°C to +150°C
- Lead Temperature (Soldering, 10s) ..... +260°C
- ESD Susceptibility
- HBM ..... 4000V
- CDM ..... 1000V

**RECOMMENDED OPERATING CONDITIONS**

- Operating Temperature Range ..... -40°C to +125°C

NOTE:

- X<sub>-</sub>: Analog Switch Inputs X0-X7.

**OVERSTRESS CAUTION**

Stresses beyond those listed in Absolute Maximum Ratings may cause permanent damage to the device. Exposure to absolute maximum rating conditions for extended periods may affect reliability. Functional operation of the device at any conditions beyond those indicated in the Recommended Operating Conditions section is not implied.

**ESD SENSITIVITY CAUTION**

This integrated circuit can be damaged if ESD protections are not considered carefully. SGMICRO recommends that all integrated circuits be handled with appropriate precautions. Failure to observe proper handling and installation procedures can cause damage. ESD damage can range from subtle performance degradation to complete device failure. Precision integrated circuits may be more susceptible to damage because even small parametric changes could cause the device not to meet the published specifications.

**DISCLAIMER**

SG Micro Corp reserves the right to make any change in circuit design, or specifications without prior notice.

PIN CONFIGURATIONS

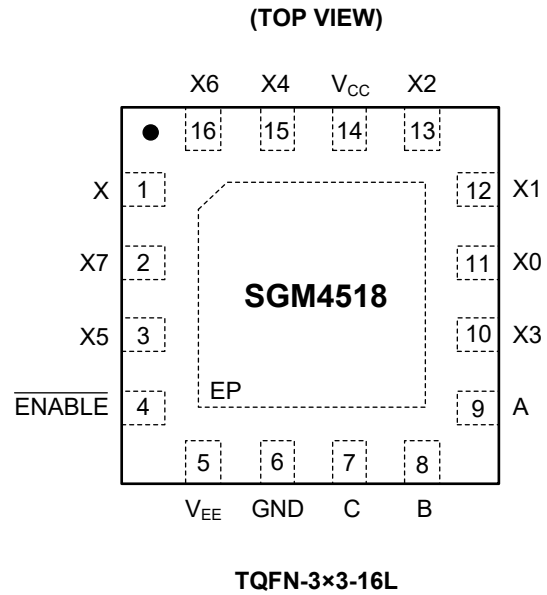
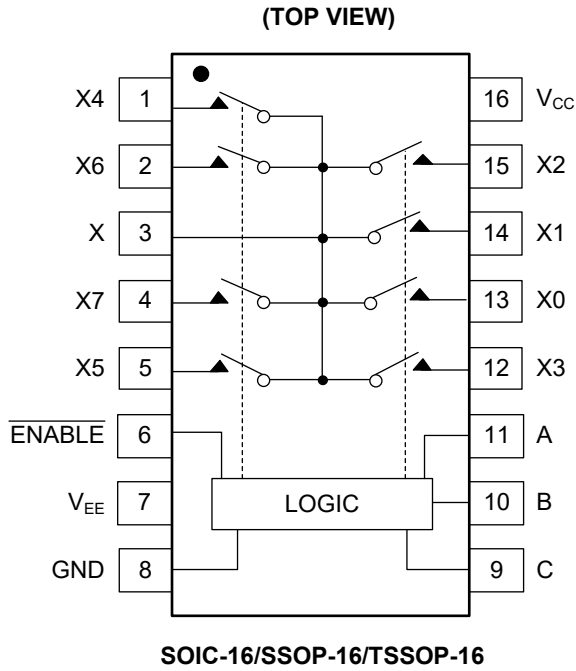

PIN DESCRIPTION

PIN		NAME	FUNCTION
SOIC-16, SSOP-16, TSSOP-16	TQFN-3x3-16L		
13, 14, 15, 12, 1, 5, 2, 4	11, 12, 13, 10, 15, 3, 16, 2	X0-X7	Analog Switch Input Pins.
3	1	X	Analog Switch Output Pin.
16	14	V <sub>CC</sub>	Positive Analog and Digital Supply Voltage Input Pin.
11	9	A	Digital Address "A" Input Pin.
10	8	B	Digital Address "B" Input Pin.
9	7	C	Digital Address "C" Input Pin.
8	6	GND	Ground.
7	5	V <sub>EE</sub>	Negative Analog Supply Voltage Input Pin. Connect to GND for single-supply operation.
6	4	ENABLE	Digital Enable Control Input Pin (Active Low). Normally connected to GND.
—	Exposed Pad	EP	Exposed Pad. It can be connected to V <sub>EE</sub> or be left floating.

NOTE:

Any input terminal can be used as an output terminal, and any output terminal can also be used as an input terminal. Signal transmission in both directions is equally well.

PACKAGE OUTLINE DIMENSIONS

SOIC-16

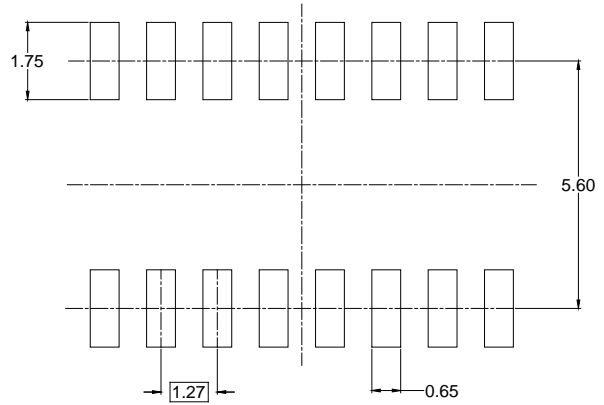
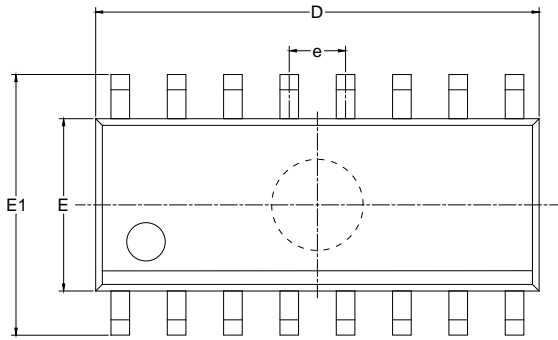

RECOMMENDED LAND PATTERN (Unit: mm)

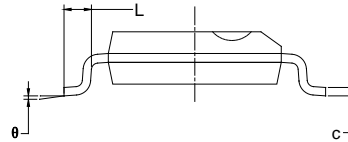
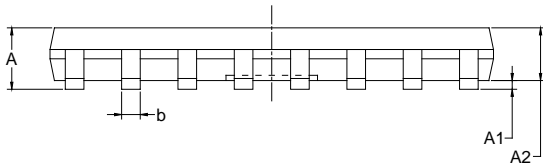

Symbol	Dimensions In Millimeters		Dimensions In Inches	
	MIN	MAX	MIN	MAX
A	1.350	1.750	0.053	0.069
A1	0.100	0.250	0.004	0.010
A2	1.350	1.550	0.053	0.061
b	0.330	0.510	0.013	0.020
c	0.170	0.250	0.006	0.010
D	9.800	10.200	0.386	0.402
E	3.800	4.000	0.150	0.157
E1	5.800	6.200	0.228	0.244
e	1.27 BSC		0.050 BSC	
L	0.400	1.270	0.016	0.050
θ	0°	8°	0°	8°

NOTES:

1. Body dimensions do not include mode flash or protrusion.
2. This drawing is subject to change without notice.

PACKAGE OUTLINE DIMENSIONS

SSOP-16

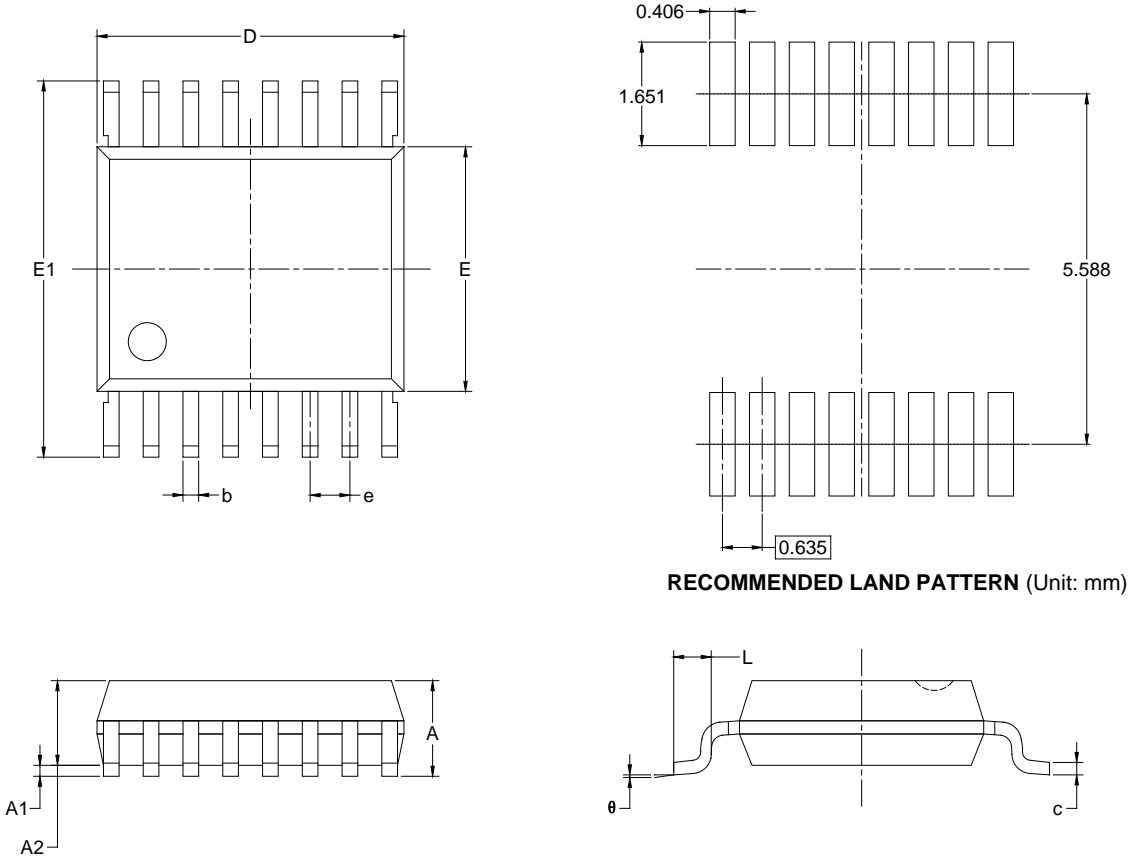

RECOMMENDED LAND PATTERN (Unit: mm)

Symbol	Dimensions In Millimeters		Dimensions In Inches	
	MIN	MAX	MIN	MAX
A	1.350	1.750	0.053	0.069
A1	0.100	0.250	0.004	0.010
A2	1.350	1.550	0.053	0.061
b	0.200	0.300	0.008	0.012
c	0.170	0.250	0.007	0.010
D	4.700	5.100	0.185	0.200
E	3.800	4.000	0.150	0.157
E1	5.800	6.200	0.228	0.244
e	0.635 BSC		0.025 BSC	
L	0.400	1.270	0.016	0.050
θ	0°	8°	0°	8°

NOTES:  
 1. Body dimensions do not include mode flash or protrusion.  
 2. This drawing is subject to change without notice.

PACKAGE OUTLINE DIMENSIONS

TSSOP-16

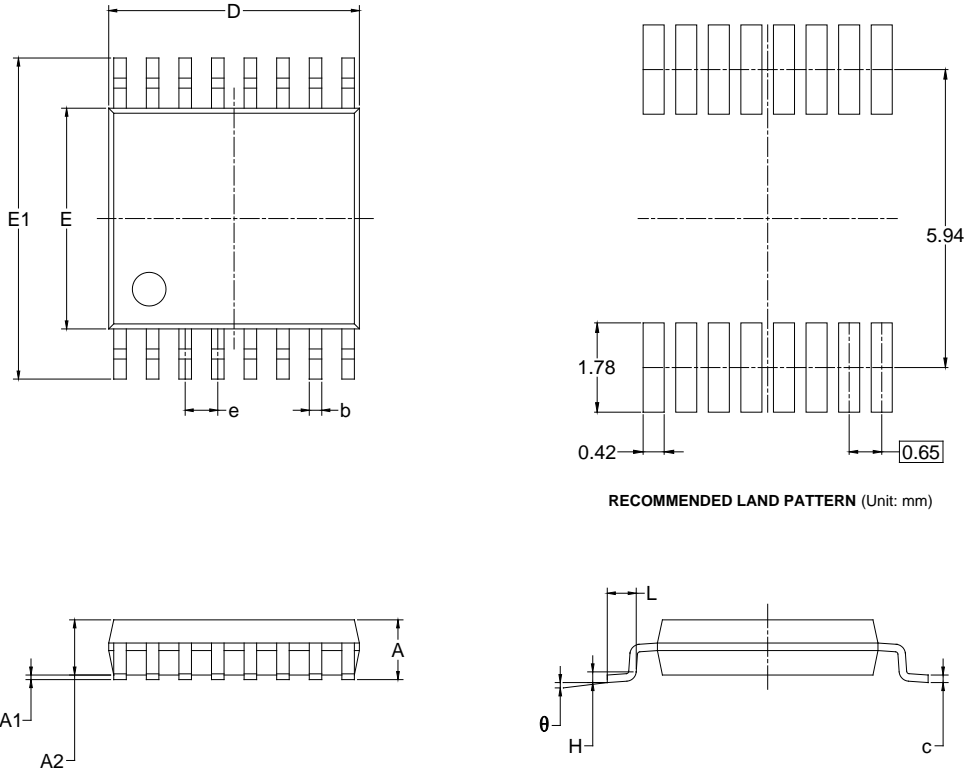

RECOMMENDED LAND PATTERN (Unit: mm)

Symbol	Dimensions In Millimeters		Dimensions In Inches	
	MIN	MAX	MIN	MAX
A		1.200		0.047
A1	0.050	0.150	0.002	0.006
A2	0.800	1.050	0.031	0.041
b	0.190	0.300	0.007	0.012
c	0.090	0.200	0.004	0.008
D	4.860	5.100	0.191	0.201
E	4.300	4.500	0.169	0.177
E1	6.200	6.600	0.244	0.260
e	0.650 BSC		0.026 BSC	
L	0.500	0.700	0.02	0.028
H	0.25 TYP		0.01 TYP	
$\theta$	1°	7°	1°	7°

- NOTES:
1. Body dimensions do not include mode flash or protrusion.
  2. This drawing is subject to change without notice.

# PACKAGE INFORMATION

## PACKAGE OUTLINE DIMENSIONS

### TQFN-3x3-16L

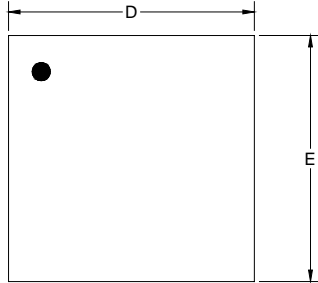

TOP VIEW

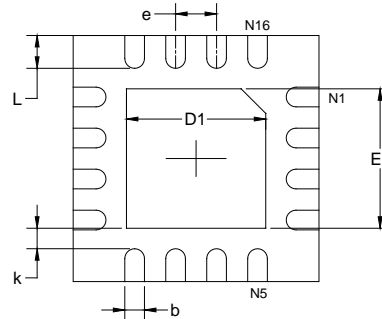

BOTTOM VIEW

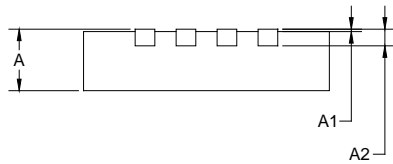

SIDE VIEW

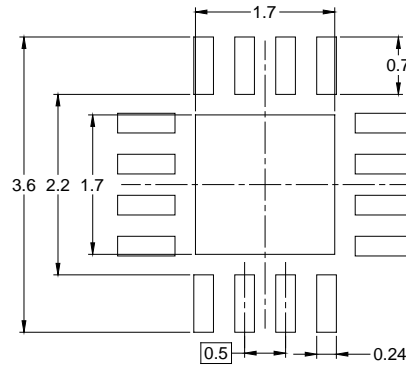

RECOMMENDED LAND PATTERN (Unit: mm)

Symbol	Dimensions In Millimeters		Dimensions In Inches	
	MIN	MAX	MIN	MAX
A	0.700	0.800	0.028	0.031
A1	0.000	0.050	0.000	0.002
A2	0.203 REF		0.008 REF	
D	2.900	3.100	0.114	0.122
D1	1.600	1.800	0.063	0.071
E	2.900	3.100	0.114	0.122
E1	1.600	1.800	0.063	0.071
k	0.200 MIN		0.008 MIN	
b	0.180	0.300	0.007	0.012
e	0.500 TYP		0.020 TYP	
L	0.300	0.500	0.012	0.020

NOTE: This drawing is subject to change without notice.

# PACKAGE INFORMATION

## TAPE AND REEL INFORMATION

### REEL DIMENSIONS



### TAPE DIMENSIONS



NOTE: The picture is only for reference. Please make the object as the standard.

### KEY PARAMETER LIST OF TAPE AND REEL

Package Type	Reel Diameter	Reel Width W1 (mm)	A0 (mm)	B0 (mm)	K0 (mm)	P0 (mm)	P1 (mm)	P2 (mm)	W (mm)	Pin1 Quadrant
SOIC-16	13"	16.4	6.50	10.30	2.10	4.0	8.0	2.0	16.0	Q1
SSOP-16	13"	12.4	6.40	5.40	2.10	4.0	8.0	2.0	12.0	Q1
TSSOP-16	13"	12.4	6.90	5.60	1.20	4.0	8.0	2.0	12.0	Q1
TQFN-3×3-16L	13"	12.4	3.35	3.35	1.13	4.0	8.0	2.0	12.0	Q2

D00001



# PACKAGE INFORMATION

## CARTON BOX DIMENSIONS



NOTE: The picture is only for reference. Please make the object as the standard.

## KEY PARAMETER LIST OF CARTON BOX

Reel Type	Length (mm)	Width (mm)	Height (mm)	Pizza/Carton
13"	386	280	370	5

DD0002