

### GENERAL DESCRIPTION

The SGM41100V is designed for primary protection of Li-Ion/polymer rechargeable cells. The product integrates all the protections required for safe operation of polymer rechargeable cells. The device is packaged in a tiny and thin package. Its small solution size leaves more space for fitting the battery cell into a given cavity for small size wearable devices.

The SGM41100V integrates all the protections and the required low on-resistance disconnect switch on one die. The protection features include charge and discharge protection, detection and protection of a cell in charge over-voltage, charge over-current, discharge under-voltage and discharge over-current. Charge and discharge are prohibited when the battery is lower than the certain voltage and under-voltage. The product also disconnects the battery pack in the case of deep discharge.

The SGM41100V operates in -40°C to +85°C temperature range, and is in a thin and low profile UTDFN-1.5×2-6L package. This package with a nominal height of 0.5mm is convenient for small cell packing designs.

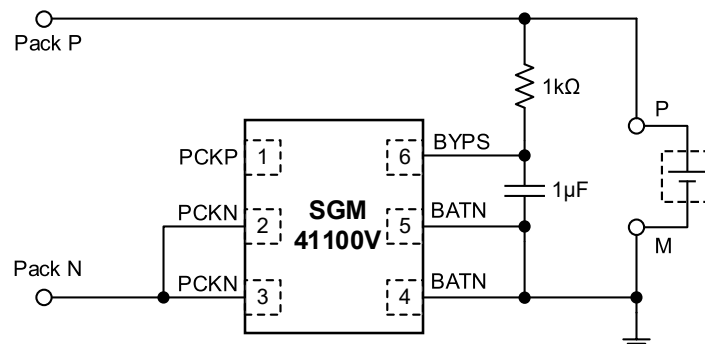
### FEATURES

- **Ultra-Compact Protection Solution**
- **Pass Resistance: 42mΩ (TYP)**
- **Operation Current: 1.1μA (TYP)**
- **Factory Programmable OVP Threshold Options**  
4.20V to 4.575V with 0.025V per Step
- **Charge/Discharge Over-Current Protection**  
3 Thresholds Combination Options
- **Battery Under-Voltage Protection**  
2.6V/2.7V/2.8V/3.0V Options
- **50nA Deep Discharge Shutdown**
- **Input Surge Clamping**
- **Input Over-Voltage Safe**
- **Load Short-Circuit Safe**
- **Reverse Polarity Battery Safe**
- **Input Reversed-Attaching Safe**
- **Battery Pack Paralleling Safe**
- **Locked-Off for Delivery/Assembly**
- **Available in a Green UTDFN-1.5×2-6L Package**

### APPLICATIONS

- IoT Gadgets
- Wearable Devices
- Battery Packs

### TYPICAL APPLICATION



NOTE: The short-circuit of both ends (P and M) of the battery should be avoided during the battery assembly process.

Figure 1. Typical Application Circuit

## PACKAGE/ORDERING INFORMATION

MODEL	PACKAGE DESCRIPTION	SPECIFIED TEMPERATURE RANGE	ORDERING NUMBER	PACKAGE MARKING	PACKING OPTION
SGM41100V-420M01	UTDFN-1.5×2-6L	-40°C to +85°C	SGM41100V-420M01YUDT6G/TR	RE2 XXX	Tape and Reel, 3000
SGM41100V-420M02	UTDFN-1.5×2-6L	-40°C to +85°C	SGM41100V-420M02YUDT6G/TR	RE3 XXX	Tape and Reel, 3000
SGM41100V-420M04	UTDFN-1.5×2-6L	-40°C to +85°C	SGM41100V-420M04YUDT6G/TR	RE4 XXX	Tape and Reel, 3000
SGM41100V-420N01	UTDFN-1.5×2-6L	-40°C to +85°C	SGM41100V-420N01YUDT6G/TR	RE5 XXX	Tape and Reel, 3000
SGM41100V-420N02	UTDFN-1.5×2-6L	-40°C to +85°C	SGM41100V-420N02YUDT6G/TR	RE6 XXX	Tape and Reel, 3000
SGM41100V-420N04	UTDFN-1.5×2-6L	-40°C to +85°C	SGM41100V-420N04YUDT6G/TR	RE7 XXX	Tape and Reel, 3000
SGM41100V-420O01	UTDFN-1.5×2-6L	-40°C to +85°C	SGM41100V-420O01YUDT6G/TR	RE8 XXX	Tape and Reel, 3000
SGM41100V-420O02	UTDFN-1.5×2-6L	-40°C to +85°C	SGM41100V-420O02YUDT6G/TR	RE9 XXX	Tape and Reel, 3000
SGM41100V-420O04	UTDFN-1.5×2-6L	-40°C to +85°C	SGM41100V-420O04YUDT6G/TR	REA XXX	Tape and Reel, 3000
SGM41100V-420P01	UTDFN-1.5×2-6L	-40°C to +85°C	SGM41100V-420P01YUDT6G/TR	REB XXX	Tape and Reel, 3000
SGM41100V-420P02	UTDFN-1.5×2-6L	-40°C to +85°C	SGM41100V-420P02YUDT6G/TR	REC XXX	Tape and Reel, 3000
SGM41100V-420P04	UTDFN-1.5×2-6L	-40°C to +85°C	SGM41100V-420P04YUDT6G/TR	RED XXX	Tape and Reel, 3000
SGM41100V-423M01	UTDFN-1.5×2-6L	-40°C to +85°C	SGM41100V-423M01YUDT6G/TR	REE XXX	Tape and Reel, 3000
SGM41100V-423M02	UTDFN-1.5×2-6L	-40°C to +85°C	SGM41100V-423M02YUDT6G/TR	REF XXX	Tape and Reel, 3000
SGM41100V-423M04	UTDFN-1.5×2-6L	-40°C to +85°C	SGM41100V-423M04YUDT6G/TR	RF0 XXX	Tape and Reel, 3000
SGM41100V-423N01	UTDFN-1.5×2-6L	-40°C to +85°C	SGM41100V-423N01YUDT6G/TR	RF1 XXX	Tape and Reel, 3000
SGM41100V-423N02	UTDFN-1.5×2-6L	-40°C to +85°C	SGM41100V-423N02YUDT6G/TR	RF2 XXX	Tape and Reel, 3000
SGM41100V-423N04	UTDFN-1.5×2-6L	-40°C to +85°C	SGM41100V-423N04YUDT6G/TR	RF3 XXX	Tape and Reel, 3000
SGM41100V-423O01	UTDFN-1.5×2-6L	-40°C to +85°C	SGM41100V-423O01YUDT6G/TR	RF4 XXX	Tape and Reel, 3000
SGM41100V-423O02	UTDFN-1.5×2-6L	-40°C to +85°C	SGM41100V-423O02YUDT6G/TR	RF5 XXX	Tape and Reel, 3000
SGM41100V-423O04	UTDFN-1.5×2-6L	-40°C to +85°C	SGM41100V-423O04YUDT6G/TR	RF6 XXX	Tape and Reel, 3000
SGM41100V-423P01	UTDFN-1.5×2-6L	-40°C to +85°C	SGM41100V-423P01YUDT6G/TR	RF7 XXX	Tape and Reel, 3000
SGM41100V-423P02	UTDFN-1.5×2-6L	-40°C to +85°C	SGM41100V-423P02YUDT6G/TR	RF8 XXX	Tape and Reel, 3000
SGM41100V-423P04	UTDFN-1.5×2-6L	-40°C to +85°C	SGM41100V-423P04YUDT6G/TR	RF9 XXX	Tape and Reel, 3000
SGM41100V-425M01	UTDFN-1.5×2-6L	-40°C to +85°C	SGM41100V-425M01YUDT6G/TR	RFA XXX	Tape and Reel, 3000
SGM41100V-425M02	UTDFN-1.5×2-6L	-40°C to +85°C	SGM41100V-425M02YUDT6G/TR	RFB XXX	Tape and Reel, 3000

# SGM41100V

## True Monolithic Li-Ion/Polymer Battery Protector in Tiny Thin Package

MODEL	PACKAGE DESCRIPTION	SPECIFIED TEMPERATURE RANGE	ORDERING NUMBER	PACKAGE MARKING	PACKING OPTION
SGM41100V-425M04	UTDFN-1.5×2-6L	-40°C to +85°C	SGM41100V-425M04YUDT6G/TR	RFC XXX	Tape and Reel, 3000
SGM41100V-425N01	UTDFN-1.5×2-6L	-40°C to +85°C	SGM41100V-425N01YUDT6G/TR	RFD XXX	Tape and Reel, 3000
SGM41100V-425N02	UTDFN-1.5×2-6L	-40°C to +85°C	SGM41100V-425N02YUDT6G/TR	RFE XXX	Tape and Reel, 3000
SGM41100V-425N04	UTDFN-1.5×2-6L	-40°C to +85°C	SGM41100V-425N04YUDT6G/TR	RFF XXX	Tape and Reel, 3000
SGM41100V-425O01	UTDFN-1.5×2-6L	-40°C to +85°C	SGM41100V-425O01YUDT6G/TR	RG0 XXX	Tape and Reel, 3000
SGM41100V-425O02	UTDFN-1.5×2-6L	-40°C to +85°C	SGM41100V-425O02YUDT6G/TR	RG1 XXX	Tape and Reel, 3000
SGM41100V-425O04	UTDFN-1.5×2-6L	-40°C to +85°C	SGM41100V-425O04YUDT6G/TR	RG2 XXX	Tape and Reel, 3000
SGM41100V-425P01	UTDFN-1.5×2-6L	-40°C to +85°C	SGM41100V-425P01YUDT6G/TR	RG3 XXX	Tape and Reel, 3000
SGM41100V-425P02	UTDFN-1.5×2-6L	-40°C to +85°C	SGM41100V-425P02YUDT6G/TR	RG4 XXX	Tape and Reel, 3000
SGM41100V-425P04	UTDFN-1.5×2-6L	-40°C to +85°C	SGM41100V-425P04YUDT6G/TR	RG5 XXX	Tape and Reel, 3000
SGM41100V-428M01	UTDFN-1.5×2-6L	-40°C to +85°C	SGM41100V-428M01YUDT6G/TR	RG6 XXX	Tape and Reel, 3000
SGM41100V-428M02	UTDFN-1.5×2-6L	-40°C to +85°C	SGM41100V-428M02YUDT6G/TR	RG7 XXX	Tape and Reel, 3000
SGM41100V-428M04	UTDFN-1.5×2-6L	-40°C to +85°C	SGM41100V-428M04YUDT6G/TR	RG8 XXX	Tape and Reel, 3000
SGM41100V-428N01	UTDFN-1.5×2-6L	-40°C to +85°C	SGM41100V-428N01YUDT6G/TR	RG9 XXX	Tape and Reel, 3000
SGM41100V-428N02	UTDFN-1.5×2-6L	-40°C to +85°C	SGM41100V-428N02YUDT6G/TR	RGA XXX	Tape and Reel, 3000
SGM41100V-428N04	UTDFN-1.5×2-6L	-40°C to +85°C	SGM41100V-428N04YUDT6G/TR	RGB XXX	Tape and Reel, 3000
SGM41100V-428O01	UTDFN-1.5×2-6L	-40°C to +85°C	SGM41100V-428O01YUDT6G/TR	RGC XXX	Tape and Reel, 3000
SGM41100V-428O02	UTDFN-1.5×2-6L	-40°C to +85°C	SGM41100V-428O02YUDT6G/TR	RGD XXX	Tape and Reel, 3000
SGM41100V-428O04	UTDFN-1.5×2-6L	-40°C to +85°C	SGM41100V-428O04YUDT6G/TR	RGE XXX	Tape and Reel, 3000
SGM41100V-428P01	UTDFN-1.5×2-6L	-40°C to +85°C	SGM41100V-428P01YUDT6G/TR	RGF XXX	Tape and Reel, 3000
SGM41100V-428P02	UTDFN-1.5×2-6L	-40°C to +85°C	SGM41100V-428P02YUDT6G/TR	RH0 XXX	Tape and Reel, 3000
SGM41100V-428P04	UTDFN-1.5×2-6L	-40°C to +85°C	SGM41100V-428P04YUDT6G/TR	RH1 XXX	Tape and Reel, 3000
SGM41100V-430M01	UTDFN-1.5×2-6L	-40°C to +85°C	SGM41100V-430M01YUDT6G/TR	RH2 XXX	Tape and Reel, 3000
SGM41100V-430M02	UTDFN-1.5×2-6L	-40°C to +85°C	SGM41100V-430M02YUDT6G/TR	RH3 XXX	Tape and Reel, 3000
SGM41100V-430M04	UTDFN-1.5×2-6L	-40°C to +85°C	SGM41100V-430M04YUDT6G/TR	RH4 XXX	Tape and Reel, 3000
SGM41100V-430N01	UTDFN-1.5×2-6L	-40°C to +85°C	SGM41100V-430N01YUDT6G/TR	RH5 XXX	Tape and Reel, 3000
SGM41100V-430N02	UTDFN-1.5×2-6L	-40°C to +85°C	SGM41100V-430N02YUDT6G/TR	RH6 XXX	Tape and Reel, 3000

# SGM41100V

## True Monolithic Li-Ion/Polymer Battery Protector in Tiny Thin Package

MODEL	PACKAGE DESCRIPTION	SPECIFIED TEMPERATURE RANGE	ORDERING NUMBER	PACKAGE MARKING	PACKING OPTION
SGM41100V-430N04	UTDFN-1.5×2-6L	-40°C to +85°C	SGM41100V-430N04YUDT6G/TR	RH7 XXX	Tape and Reel, 3000
SGM41100V-430O01	UTDFN-1.5×2-6L	-40°C to +85°C	SGM41100V-430O01YUDT6G/TR	RH8 XXX	Tape and Reel, 3000
SGM41100V-430O02	UTDFN-1.5×2-6L	-40°C to +85°C	SGM41100V-430O02YUDT6G/TR	RH9 XXX	Tape and Reel, 3000
SGM41100V-430O04	UTDFN-1.5×2-6L	-40°C to +85°C	SGM41100V-430O04YUDT6G/TR	RHA XXX	Tape and Reel, 3000
SGM41100V-430P01	UTDFN-1.5×2-6L	-40°C to +85°C	SGM41100V-430P01YUDT6G/TR	R48 XXX	Tape and Reel, 3000
SGM41100V-430P02	UTDFN-1.5×2-6L	-40°C to +85°C	SGM41100V-430P02YUDT6G/TR	R49 XXX	Tape and Reel, 3000
SGM41100V-430P04	UTDFN-1.5×2-6L	-40°C to +85°C	SGM41100V-430P04YUDT6G/TR	R4A XXX	Tape and Reel, 3000
SGM41100V-433M01	UTDFN-1.5×2-6L	-40°C to +85°C	SGM41100V-433M01YUDT6G/TR	RHB XXX	Tape and Reel, 3000
SGM41100V-433M02	UTDFN-1.5×2-6L	-40°C to +85°C	SGM41100V-433M02YUDT6G/TR	RHC XXX	Tape and Reel, 3000
SGM41100V-433M04	UTDFN-1.5×2-6L	-40°C to +85°C	SGM41100V-433M04YUDT6G/TR	RHD XXX	Tape and Reel, 3000
SGM41100V-433N01	UTDFN-1.5×2-6L	-40°C to +85°C	SGM41100V-433N01YUDT6G/TR	RHE XXX	Tape and Reel, 3000
SGM41100V-433N02	UTDFN-1.5×2-6L	-40°C to +85°C	SGM41100V-433N02YUDT6G/TR	RHF XXX	Tape and Reel, 3000
SGM41100V-433N04	UTDFN-1.5×2-6L	-40°C to +85°C	SGM41100V-433N04YUDT6G/TR	RI0 XXX	Tape and Reel, 3000
SGM41100V-433O01	UTDFN-1.5×2-6L	-40°C to +85°C	SGM41100V-433O01YUDT6G/TR	RI1 XXX	Tape and Reel, 3000
SGM41100V-433O02	UTDFN-1.5×2-6L	-40°C to +85°C	SGM41100V-433O02YUDT6G/TR	RI2 XXX	Tape and Reel, 3000
SGM41100V-433O04	UTDFN-1.5×2-6L	-40°C to +85°C	SGM41100V-433O04YUDT6G/TR	RI3 XXX	Tape and Reel, 3000
SGM41100V-433P01	UTDFN-1.5×2-6L	-40°C to +85°C	SGM41100V-433P01YUDT6G/TR	RI4 XXX	Tape and Reel, 3000
SGM41100V-433P02	UTDFN-1.5×2-6L	-40°C to +85°C	SGM41100V-433P02YUDT6G/TR	RI5 XXX	Tape and Reel, 3000
SGM41100V-433P04	UTDFN-1.5×2-6L	-40°C to +85°C	SGM41100V-433P04YUDT6G/TR	RI6 XXX	Tape and Reel, 3000
SGM41100V-435M01	UTDFN-1.5×2-6L	-40°C to +85°C	SGM41100V-435M01YUDT6G/TR	RI7 XXX	Tape and Reel, 3000
SGM41100V-435M02	UTDFN-1.5×2-6L	-40°C to +85°C	SGM41100V-435M02YUDT6G/TR	RI8 XXX	Tape and Reel, 3000
SGM41100V-435M04	UTDFN-1.5×2-6L	-40°C to +85°C	SGM41100V-435M04YUDT6G/TR	RI9 XXX	Tape and Reel, 3000
SGM41100V-435N01	UTDFN-1.5×2-6L	-40°C to +85°C	SGM41100V-435N01YUDT6G/TR	RIA XXX	Tape and Reel, 3000
SGM41100V-435N02	UTDFN-1.5×2-6L	-40°C to +85°C	SGM41100V-435N02YUDT6G/TR	RIB XXX	Tape and Reel, 3000
SGM41100V-435N04	UTDFN-1.5×2-6L	-40°C to +85°C	SGM41100V-435N04YUDT6G/TR	RIC XXX	Tape and Reel, 3000
SGM41100V-435O01	UTDFN-1.5×2-6L	-40°C to +85°C	SGM41100V-435O01YUDT6G/TR	RID XXX	Tape and Reel, 3000
SGM41100V-435O02	UTDFN-1.5×2-6L	-40°C to +85°C	SGM41100V-435O02YUDT6G/TR	RIE XXX	Tape and Reel, 3000

# SGM41100V

# True Monolithic Li-Ion/Polymer Battery Protector in Tiny Thin Package

MODEL	PACKAGE DESCRIPTION	SPECIFIED TEMPERATURE RANGE	ORDERING NUMBER	PACKAGE MARKING	PACKING OPTION
SGM41100V-435O04	UTDFN-1.5×2-6L	-40°C to +85°C	SGM41100V-435O04YUDT6G/TR	RIF XXX	Tape and Reel, 3000
SGM41100V-435P01	UTDFN-1.5×2-6L	-40°C to +85°C	SGM41100V-435P01YUDT6G/TR	RJ0 XXX	Tape and Reel, 3000
SGM41100V-435P02	UTDFN-1.5×2-6L	-40°C to +85°C	SGM41100V-435P02YUDT6G/TR	RJ1 XXX	Tape and Reel, 3000
SGM41100V-435P04	UTDFN-1.5×2-6L	-40°C to +85°C	SGM41100V-435P04YUDT6G/TR	RJ2 XXX	Tape and Reel, 3000
SGM41100V-438M01	UTDFN-1.5×2-6L	-40°C to +85°C	SGM41100V-438M01YUDT6G/TR	RJ3 XXX	Tape and Reel, 3000
SGM41100V-438M02	UTDFN-1.5×2-6L	-40°C to +85°C	SGM41100V-438M02YUDT6G/TR	RJ4 XXX	Tape and Reel, 3000
SGM41100V-438M04	UTDFN-1.5×2-6L	-40°C to +85°C	SGM41100V-438M04YUDT6G/TR	RJ5 XXX	Tape and Reel, 3000
SGM41100V-438N01	UTDFN-1.5×2-6L	-40°C to +85°C	SGM41100V-438N01YUDT6G/TR	RJ6 XXX	Tape and Reel, 3000
SGM41100V-438N02	UTDFN-1.5×2-6L	-40°C to +85°C	SGM41100V-438N02YUDT6G/TR	RJ7 XXX	Tape and Reel, 3000
SGM41100V-438N04	UTDFN-1.5×2-6L	-40°C to +85°C	SGM41100V-438N04YUDT6G/TR	RJ8 XXX	Tape and Reel, 3000
SGM41100V-438O01	UTDFN-1.5×2-6L	-40°C to +85°C	SGM41100V-438O01YUDT6G/TR	RJ9 XXX	Tape and Reel, 3000
SGM41100V-438O02	UTDFN-1.5×2-6L	-40°C to +85°C	SGM41100V-438O02YUDT6G/TR	RJA XXX	Tape and Reel, 3000
SGM41100V-438O04	UTDFN-1.5×2-6L	-40°C to +85°C	SGM41100V-438O04YUDT6G/TR	RJB XXX	Tape and Reel, 3000
SGM41100V-438P01	UTDFN-1.5×2-6L	-40°C to +85°C	SGM41100V-438P01YUDT6G/TR	RJC XXX	Tape and Reel, 3000
SGM41100V-438P02	UTDFN-1.5×2-6L	-40°C to +85°C	SGM41100V-438P02YUDT6G/TR	RJD XXX	Tape and Reel, 3000
SGM41100V-438P04	UTDFN-1.5×2-6L	-40°C to +85°C	SGM41100V-438P04YUDT6G/TR	RJE XXX	Tape and Reel, 3000
SGM41100V-440M01	UTDFN-1.5×2-6L	-40°C to +85°C	SGM41100V-440M01YUDT6G/TR	RJF XXX	Tape and Reel, 3000
SGM41100V-440M02	UTDFN-1.5×2-6L	-40°C to +85°C	SGM41100V-440M02YUDT6G/TR	RK0 XXX	Tape and Reel, 3000
SGM41100V-440M04	UTDFN-1.5×2-6L	-40°C to +85°C	SGM41100V-440M04YUDT6G/TR	RK1 XXX	Tape and Reel, 3000
SGM41100V-440N01	UTDFN-1.5×2-6L	-40°C to +85°C	SGM41100V-440N01YUDT6G/TR	RK2 XXX	Tape and Reel, 3000
SGM41100V-440N02	UTDFN-1.5×2-6L	-40°C to +85°C	SGM41100V-440N02YUDT6G/TR	RK3 XXX	Tape and Reel, 3000
SGM41100V-440N04	UTDFN-1.5×2-6L	-40°C to +85°C	SGM41100V-440N04YUDT6G/TR	RK4 XXX	Tape and Reel, 3000
SGM41100V-440O01	UTDFN-1.5×2-6L	-40°C to +85°C	SGM41100V-440O01YUDT6G/TR	RK5 XXX	Tape and Reel, 3000
SGM41100V-440O02	UTDFN-1.5×2-6L	-40°C to +85°C	SGM41100V-440O02YUDT6G/TR	RK6 XXX	Tape and Reel, 3000
SGM41100V-440O04	UTDFN-1.5×2-6L	-40°C to +85°C	SGM41100V-440O04YUDT6G/TR	RK7 XXX	Tape and Reel, 3000
SGM41100V-440P01	UTDFN-1.5×2-6L	-40°C to +85°C	SGM41100V-440P01YUDT6G/TR	RK8 XXX	Tape and Reel, 3000
SGM41100V-440P02	UTDFN-1.5×2-6L	-40°C to +85°C	SGM41100V-440P02YUDT6G/TR	RK9 XXX	Tape and Reel, 3000

# SGM41100V

## True Monolithic Li-Ion/Polymer Battery Protector in Tiny Thin Package

MODEL	PACKAGE DESCRIPTION	SPECIFIED TEMPERATURE RANGE	ORDERING NUMBER	PACKAGE MARKING	PACKING OPTION
SGM41100V-440P04	UTDFN-1.5×2-6L	-40°C to +85°C	SGM41100V-440P04YUDT6G/TR	RKA XXX	Tape and Reel, 3000
SGM41100V-443M01	UTDFN-1.5×2-6L	-40°C to +85°C	SGM41100V-443M01YUDT6G/TR	RKB XXX	Tape and Reel, 3000
SGM41100V-443M02	UTDFN-1.5×2-6L	-40°C to +85°C	SGM41100V-443M02YUDT6G/TR	RKC XXX	Tape and Reel, 3000
SGM41100V-443M04	UTDFN-1.5×2-6L	-40°C to +85°C	SGM41100V-443M04YUDT6G/TR	RKD XXX	Tape and Reel, 3000
SGM41100V-443N01	UTDFN-1.5×2-6L	-40°C to +85°C	SGM41100V-443N01YUDT6G/TR	RKE XXX	Tape and Reel, 3000
SGM41100V-443N02	UTDFN-1.5×2-6L	-40°C to +85°C	SGM41100V-443N02YUDT6G/TR	RKF XXX	Tape and Reel, 3000
SGM41100V-443N04	UTDFN-1.5×2-6L	-40°C to +85°C	SGM41100V-443N04YUDT6G/TR	RL0 XXX	Tape and Reel, 3000
SGM41100V-443O01	UTDFN-1.5×2-6L	-40°C to +85°C	SGM41100V-443O01YUDT6G/TR	RL1 XXX	Tape and Reel, 3000
SGM41100V-443O02	UTDFN-1.5×2-6L	-40°C to +85°C	SGM41100V-443O02YUDT6G/TR	RL2 XXX	Tape and Reel, 3000
SGM41100V-443O04	UTDFN-1.5×2-6L	-40°C to +85°C	SGM41100V-443O04YUDT6G/TR	RL3 XXX	Tape and Reel, 3000
SGM41100V-443P01	UTDFN-1.5×2-6L	-40°C to +85°C	SGM41100V-443P01YUDT6G/TR	RL4 XXX	Tape and Reel, 3000
SGM41100V-443P02	UTDFN-1.5×2-6L	-40°C to +85°C	SGM41100V-443P02YUDT6G/TR	RL5 XXX	Tape and Reel, 3000
SGM41100V-443P04	UTDFN-1.5×2-6L	-40°C to +85°C	SGM41100V-443P04YUDT6G/TR	RL6 XXX	Tape and Reel, 3000
SGM41100V-445M01	UTDFN-1.5×2-6L	-40°C to +85°C	SGM41100V-445M01YUDT6G/TR	RL7 XXX	Tape and Reel, 3000
SGM41100V-445M02	UTDFN-1.5×2-6L	-40°C to +85°C	SGM41100V-445M02YUDT6G/TR	RL8 XXX	Tape and Reel, 3000
SGM41100V-445M04	UTDFN-1.5×2-6L	-40°C to +85°C	SGM41100V-445M04YUDT6G/TR	RL9 XXX	Tape and Reel, 3000
SGM41100V-445N01	UTDFN-1.5×2-6L	-40°C to +85°C	SGM41100V-445N01YUDT6G/TR	RLA XXX	Tape and Reel, 3000
SGM41100V-445N02	UTDFN-1.5×2-6L	-40°C to +85°C	SGM41100V-445N02YUDT6G/TR	RLB XXX	Tape and Reel, 3000
SGM41100V-445N04	UTDFN-1.5×2-6L	-40°C to +85°C	SGM41100V-445N04YUDT6G/TR	RLC XXX	Tape and Reel, 3000
SGM41100V-445O01	UTDFN-1.5×2-6L	-40°C to +85°C	SGM41100V-445O01YUDT6G/TR	RLD XXX	Tape and Reel, 3000
SGM41100V-445O02	UTDFN-1.5×2-6L	-40°C to +85°C	SGM41100V-445O02YUDT6G/TR	RLE XXX	Tape and Reel, 3000
SGM41100V-445O04	UTDFN-1.5×2-6L	-40°C to +85°C	SGM41100V-445O04YUDT6G/TR	RLF XXX	Tape and Reel, 3000
SGM41100V-445P01	UTDFN-1.5×2-6L	-40°C to +85°C	SGM41100V-445P01YUDT6G/TR	RM0 XXX	Tape and Reel, 3000
SGM41100V-445P02	UTDFN-1.5×2-6L	-40°C to +85°C	SGM41100V-445P02YUDT6G/TR	RM1 XXX	Tape and Reel, 3000
SGM41100V-445P04	UTDFN-1.5×2-6L	-40°C to +85°C	SGM41100V-445P04YUDT6G/TR	RM2 XXX	Tape and Reel, 3000
SGM41100V-448M01	UTDFN-1.5×2-6L	-40°C to +85°C	SGM41100V-448M01YUDT6G/TR	RM3 XXX	Tape and Reel, 3000
SGM41100V-448M02	UTDFN-1.5×2-6L	-40°C to +85°C	SGM41100V-448M02YUDT6G/TR	RM4 XXX	Tape and Reel, 3000

# SGM41100V

## True Monolithic Li-Ion/Polymer Battery Protector in Tiny Thin Package

MODEL	PACKAGE DESCRIPTION	SPECIFIED TEMPERATURE RANGE	ORDERING NUMBER	PACKAGE MARKING	PACKING OPTION
SGM41100V-448M04	UTDFN-1.5×2-6L	-40°C to +85°C	SGM41100V-448M04YUDT6G/TR	RM5 XXX	Tape and Reel, 3000
SGM41100V-448N01	UTDFN-1.5×2-6L	-40°C to +85°C	SGM41100V-448N01YUDT6G/TR	RM6 XXX	Tape and Reel, 3000
SGM41100V-448N02	UTDFN-1.5×2-6L	-40°C to +85°C	SGM41100V-448N02YUDT6G/TR	RM7 XXX	Tape and Reel, 3000
SGM41100V-448N04	UTDFN-1.5×2-6L	-40°C to +85°C	SGM41100V-448N04YUDT6G/TR	RM8 XXX	Tape and Reel, 3000
SGM41100V-448O01	UTDFN-1.5×2-6L	-40°C to +85°C	SGM41100V-448O01YUDT6G/TR	RM9 XXX	Tape and Reel, 3000
SGM41100V-448O02	UTDFN-1.5×2-6L	-40°C to +85°C	SGM41100V-448O02YUDT6G/TR	RMA XXX	Tape and Reel, 3000
SGM41100V-448O04	UTDFN-1.5×2-6L	-40°C to +85°C	SGM41100V-448O04YUDT6G/TR	RMB XXX	Tape and Reel, 3000
SGM41100V-448P01	UTDFN-1.5×2-6L	-40°C to +85°C	SGM41100V-448P01YUDT6G/TR	RMC XXX	Tape and Reel, 3000
SGM41100V-448P02	UTDFN-1.5×2-6L	-40°C to +85°C	SGM41100V-448P02YUDT6G/TR	RMD XXX	Tape and Reel, 3000
SGM41100V-448P04	UTDFN-1.5×2-6L	-40°C to +85°C	SGM41100V-448P04YUDT6G/TR	RME XXX	Tape and Reel, 3000
SGM41100V-450M01	UTDFN-1.5×2-6L	-40°C to +85°C	SGM41100V-450M01YUDT6G/TR	RMF XXX	Tape and Reel, 3000
SGM41100V-450M02	UTDFN-1.5×2-6L	-40°C to +85°C	SGM41100V-450M02YUDT6G/TR	RN0 XXX	Tape and Reel, 3000
SGM41100V-450M04	UTDFN-1.5×2-6L	-40°C to +85°C	SGM41100V-450M04YUDT6G/TR	RN1 XXX	Tape and Reel, 3000
SGM41100V-450N01	UTDFN-1.5×2-6L	-40°C to +85°C	SGM41100V-450N01YUDT6G/TR	RN2 XXX	Tape and Reel, 3000
SGM41100V-450N02	UTDFN-1.5×2-6L	-40°C to +85°C	SGM41100V-450N02YUDT6G/TR	RN3 XXX	Tape and Reel, 3000
SGM41100V-450N04	UTDFN-1.5×2-6L	-40°C to +85°C	SGM41100V-450N04YUDT6G/TR	RN4 XXX	Tape and Reel, 3000
SGM41100V-450O01	UTDFN-1.5×2-6L	-40°C to +85°C	SGM41100V-450O01YUDT6G/TR	RN5 XXX	Tape and Reel, 3000
SGM41100V-450O02	UTDFN-1.5×2-6L	-40°C to +85°C	SGM41100V-450O02YUDT6G/TR	RN6 XXX	Tape and Reel, 3000
SGM41100V-450O04	UTDFN-1.5×2-6L	-40°C to +85°C	SGM41100V-450O04YUDT6G/TR	RN7 XXX	Tape and Reel, 3000
SGM41100V-450P01	UTDFN-1.5×2-6L	-40°C to +85°C	SGM41100V-450P01YUDT6G/TR	RN8 XXX	Tape and Reel, 3000
SGM41100V-450P02	UTDFN-1.5×2-6L	-40°C to +85°C	SGM41100V-450P02YUDT6G/TR	RN9 XXX	Tape and Reel, 3000
SGM41100V-450P04	UTDFN-1.5×2-6L	-40°C to +85°C	SGM41100V-450P04YUDT6G/TR	RNA XXX	Tape and Reel, 3000
SGM41100V-453M01	UTDFN-1.5×2-6L	-40°C to +85°C	SGM41100V-453M01YUDT6G/TR	RNB XXX	Tape and Reel, 3000
SGM41100V-453M02	UTDFN-1.5×2-6L	-40°C to +85°C	SGM41100V-453M02YUDT6G/TR	RNC XXX	Tape and Reel, 3000
SGM41100V-453M04	UTDFN-1.5×2-6L	-40°C to +85°C	SGM41100V-453M04YUDT6G/TR	RND XXX	Tape and Reel, 3000
SGM41100V-453N01	UTDFN-1.5×2-6L	-40°C to +85°C	SGM41100V-453N01YUDT6G/TR	RNE XXX	Tape and Reel, 3000
SGM41100V-453N02	UTDFN-1.5×2-6L	-40°C to +85°C	SGM41100V-453N02YUDT6G/TR	RNF XXX	Tape and Reel, 3000

# SGM41100V

## True Monolithic Li-Ion/Polymer Battery Protector in Tiny Thin Package

MODEL	PACKAGE DESCRIPTION	SPECIFIED TEMPERATURE RANGE	ORDERING NUMBER	PACKAGE MARKING	PACKING OPTION
SGM41100V-453N04	UTDFN-1.5×2-6L	-40°C to +85°C	SGM41100V-453N04YUDT6G/TR	RO0 XXX	Tape and Reel, 3000
SGM41100V-453O01	UTDFN-1.5×2-6L	-40°C to +85°C	SGM41100V-453O01YUDT6G/TR	RO1 XXX	Tape and Reel, 3000
SGM41100V-453O02	UTDFN-1.5×2-6L	-40°C to +85°C	SGM41100V-453O02YUDT6G/TR	RO2 XXX	Tape and Reel, 3000
SGM41100V-453O04	UTDFN-1.5×2-6L	-40°C to +85°C	SGM41100V-453O04YUDT6G/TR	RO3 XXX	Tape and Reel, 3000
SGM41100V-453P01	UTDFN-1.5×2-6L	-40°C to +85°C	SGM41100V-453P01YUDT6G/TR	RO4 XXX	Tape and Reel, 3000
SGM41100V-453P02	UTDFN-1.5×2-6L	-40°C to +85°C	SGM41100V-453P02YUDT6G/TR	RO5 XXX	Tape and Reel, 3000
SGM41100V-453P04	UTDFN-1.5×2-6L	-40°C to +85°C	SGM41100V-453P04YUDT6G/TR	RO6 XXX	Tape and Reel, 3000
SGM41100V-455M01	UTDFN-1.5×2-6L	-40°C to +85°C	SGM41100V-455M01YUDT6G/TR	RO7 XXX	Tape and Reel, 3000
SGM41100V-455M02	UTDFN-1.5×2-6L	-40°C to +85°C	SGM41100V-455M02YUDT6G/TR	RO8 XXX	Tape and Reel, 3000
SGM41100V-455M04	UTDFN-1.5×2-6L	-40°C to +85°C	SGM41100V-455M04YUDT6G/TR	RO9 XXX	Tape and Reel, 3000
SGM41100V-455N01	UTDFN-1.5×2-6L	-40°C to +85°C	SGM41100V-455N01YUDT6G/TR	ROA XXX	Tape and Reel, 3000
SGM41100V-455N02	UTDFN-1.5×2-6L	-40°C to +85°C	SGM41100V-455N02YUDT6G/TR	ROB XXX	Tape and Reel, 3000
SGM41100V-455N04	UTDFN-1.5×2-6L	-40°C to +85°C	SGM41100V-455N04YUDT6G/TR	ROC XXX	Tape and Reel, 3000
SGM41100V-455O01	UTDFN-1.5×2-6L	-40°C to +85°C	SGM41100V-455O01YUDT6G/TR	ROD XXX	Tape and Reel, 3000
SGM41100V-455O02	UTDFN-1.5×2-6L	-40°C to +85°C	SGM41100V-455O02YUDT6G/TR	ROE XXX	Tape and Reel, 3000
SGM41100V-455O04	UTDFN-1.5×2-6L	-40°C to +85°C	SGM41100V-455O04YUDT6G/TR	ROF XXX	Tape and Reel, 3000
SGM41100V-455P01	UTDFN-1.5×2-6L	-40°C to +85°C	SGM41100V-455P01YUDT6G/TR	RP0 XXX	Tape and Reel, 3000
SGM41100V-455P02	UTDFN-1.5×2-6L	-40°C to +85°C	SGM41100V-455P02YUDT6G/TR	RP1 XXX	Tape and Reel, 3000
SGM41100V-455P04	UTDFN-1.5×2-6L	-40°C to +85°C	SGM41100V-455P04YUDT6G/TR	RP2 XXX	Tape and Reel, 3000
SGM41100V-458M01	UTDFN-1.5×2-6L	-40°C to +85°C	SGM41100V-458M01YUDT6G/TR	RP3 XXX	Tape and Reel, 3000
SGM41100V-458M02	UTDFN-1.5×2-6L	-40°C to +85°C	SGM41100V-458M02YUDT6G/TR	RP4 XXX	Tape and Reel, 3000
SGM41100V-458M04	UTDFN-1.5×2-6L	-40°C to +85°C	SGM41100V-458M04YUDT6G/TR	RP5 XXX	Tape and Reel, 3000
SGM41100V-458N01	UTDFN-1.5×2-6L	-40°C to +85°C	SGM41100V-458N01YUDT6G/TR	RP6 XXX	Tape and Reel, 3000
SGM41100V-458N02	UTDFN-1.5×2-6L	-40°C to +85°C	SGM41100V-458N02YUDT6G/TR	RP7 XXX	Tape and Reel, 3000
SGM41100V-458N04	UTDFN-1.5×2-6L	-40°C to +85°C	SGM41100V-458N04YUDT6G/TR	RP8 XXX	Tape and Reel, 3000
SGM41100V-458O01	UTDFN-1.5×2-6L	-40°C to +85°C	SGM41100V-458O01YUDT6G/TR	RP9 XXX	Tape and Reel, 3000
SGM41100V-458O02	UTDFN-1.5×2-6L	-40°C to +85°C	SGM41100V-458O02YUDT6G/TR	RPA XXX	Tape and Reel, 3000



# SGM41100V

# True Monolithic Li-Ion/Polymer Battery Protector in Tiny Thin Package

MODEL	PACKAGE DESCRIPTION	SPECIFIED TEMPERATURE RANGE	ORDERING NUMBER	PACKAGE MARKING	PACKING OPTION
SGM41100V-458O04	UTDFN-1.5×2-6L	-40°C to +85°C	SGM41100V-458O04YUDT6G/TR	RPB XXX	Tape and Reel, 3000
SGM41100V-458P01	UTDFN-1.5×2-6L	-40°C to +85°C	SGM41100V-458P01YUDT6G/TR	RPC XXX	Tape and Reel, 3000
SGM41100V-458P02	UTDFN-1.5×2-6L	-40°C to +85°C	SGM41100V-458P02YUDT6G/TR	RPD XXX	Tape and Reel, 3000
SGM41100V-458P04	UTDFN-1.5×2-6L	-40°C to +85°C	SGM41100V-458P04YUDT6G/TR	RPE XXX	Tape and Reel, 3000

## MARKING INFORMATION

NOTE: XXX = Date Code and Trace Code.

**Y Y Y** — Serial Number

**X X X**

Trace Code

Date Code - Year

Green (RoHS & HSF): SG Micro Corp defines "Green" to mean Pb-Free (RoHS compatible) and free of halogen substances. If you have additional comments or questions, please contact your SGMICRO representative directly.

## DEVICE DESCRIPTION

Model : SGM41100V-AAABCC

Over-Voltage Threshold Options								
Option Code "AAA"	<b>420</b>	<b>423</b>	<b>425</b>	<b>428</b>	<b>430</b>	<b>433</b>	<b>435</b>	<b>438</b>
Over-Voltage Threshold $V_{OV}$ (V)	4.20	4.225	4.25	4.275	4.30	4.325	4.35	4.375
Option Code "AAA"	<b>440</b>	<b>443</b>	<b>445</b>	<b>448</b>	<b>450</b>	<b>453</b>	<b>455</b>	<b>458</b>
Over-Voltage Threshold $V_{OV}$ (V)	4.40	4.425	4.45	4.475	4.50	4.525	4.55	4.575
Under-Voltage Threshold Options								
Option Code "B"	<b>M</b>		<b>N</b>		<b>O</b>		<b>P</b>	
Under-Voltage Threshold $V_{UV}$ (V)	2.6		2.7		2.8		3.0	
Current Threshold Combination Options								
Option Code "CC"	<b>01</b>			<b>02</b>			<b>04</b>	
Charge Over-Current $I_{OC}$ (A)	0.156			0.19			0.35	
Discharge Over-Current $I_{OD}$ (A)	0.169			0.30			0.56	
Short-Circuit Current (A)	4 × 0.169			4 × 0.30			4 × 0.56	

**ABSOLUTE MAXIMUM RATINGS**

Pack P to Pack N, 13V <sup>(1)</sup> , 10mA Clamping <sup>(2)</sup> .....	5s
Pack P to Pack N.....	-4.5V or +9V <sup>(3)</sup> , Continuous
Pack P to BATN.....	-4.5V <sup>(3)</sup> or +5.5V
Pack P to Pack N Short-Circuit <sup>(4)</sup> .....	Continuous
Pack P to Pack N Attachment Inrush/Outrush <sup>(5)</sup> .....	+9V/-4.5V
Pack P to BATN Attachment Inrush/Outrush <sup>(6)</sup> .....	±4.5V
Surge Current <sup>(7)</sup> .....	±20A
Junction Temperature.....	+150°C
Storage Temperature Range.....	-65°C to +150°C
Lead Temperature (Soldering, 10s).....	+260°C
ESD Susceptibility	
HBM.....	4000V
CDM.....	1000V

**NOTES:**

1. Evaluation at V<sub>BAT</sub> = 4.5V.
2. The clamping may reach 10mA at an input voltage > 13V.
3. Test with a voltage regulated supply that has 2A current limit and increase the voltage progressively for less than 1V/ms slope rate. Apply a voltage to the device under test from 0V to given voltages.
4. The device is tested after being installed on the circuit board in Figure 1. Clip a 4.5V 5A power source onto the P and M to simulate a battery and short the Pack P and the Pack N with an 80mΩ wire.
5. The device is tested after being installed on the circuit board in Figure 1. Connect a 3.2V supply and 2A sinking resistor R<sub>SINK</sub> as showed in Figure 2 to the P and M for inrush test. Clip a 4.5V 5A supply for outrush test.
6. The device is tested after being installed on the circuit board in Figure 1 with the circuit in Figure 3.
7. Parallel or connect in reverse polarity two battery packs of Figure 1. Limit the battery pack impedance to limit the surge current to 20A.

**RECOMMENDED OPERATING CONDITIONS**

Supply Voltage Range.....	0V to 5.5V
Battery Voltage Range.....	0 to 4.5V
Junction Temperature Range.....	-40°C to +85°C

**OVERSTRESS CAUTION**

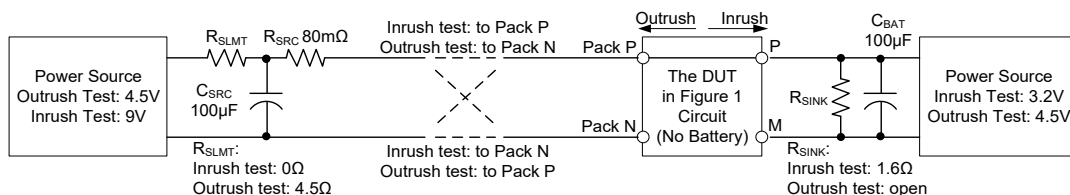
Stresses beyond those listed in Absolute Maximum Ratings may cause permanent damage to the device. Exposure to absolute maximum rating conditions for extended periods may affect reliability. Functional operation of the device at any conditions beyond those indicated in the Recommended Operating Conditions section is not implied.

**ESD SENSITIVITY CAUTION**

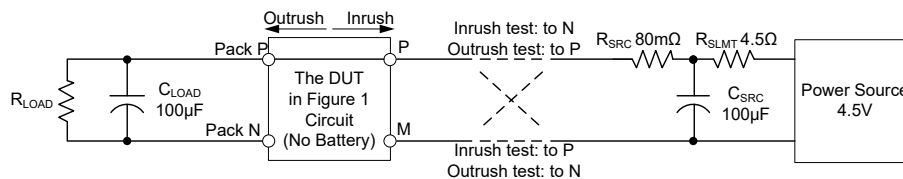
This integrated circuit can be damaged if ESD protections are not considered carefully. SGMICRO recommends that all integrated circuits be handled with appropriate precautions. Failure to observe proper handling and installation procedures can cause damage. ESD damage can range from subtle performance degradation to complete device failure. Precision integrated circuits may be more susceptible to damage because even small parametric changes could cause the device not to meet the published specifications.

**DISCLAIMER**

SG Micro Corp reserves the right to make any change in circuit design, or specifications without prior notice.

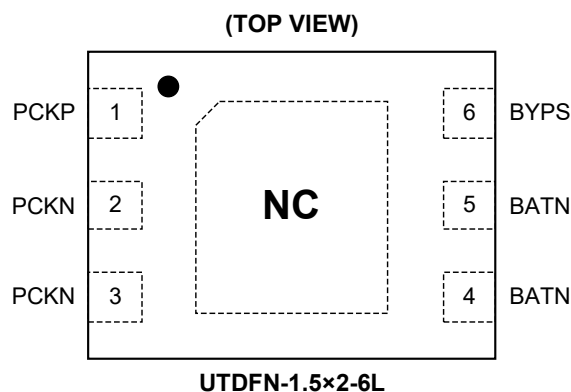


**Figure 2. Test Set-Up for Pack P to Pack N Attachment Inrush/Outrush**



**Figure 3. Test Set-Up for Pack P to BATN Attachment Inrush/Outrush**

## PIN CONFIGURATION



## PIN DESCRIPTION

PIN	NAME	TYPE	FUNCTION
1	PCKP	P	Internal Connection. No external connection.
2, 3	PCKN	P	Power Input and Output, the Battery Pack Cathode. Short this pin to BATN pin to release off the locked-open state, and make the output path closed.
4, 5	BATN	G	Ground of Internal Circuit. Connect to the battery cathode end.
6	BYPS	P	Power Supply Pin and Disconnection Locked-Off Triggering Input. Place a 1 $\mu$ F capacitor between this pin and BATN pin, and place a 1k $\Omega$ resistor between the pin and the positive connection of the battery pack. Shorting this pin to PCKN pin momentarily places the circuit into locked-open state.
Exposed Pad	NC	NC	Not Connected Internally. Connect to BATN pin externally is recommended.

NOTE: G = Ground, P = Power for the Circuit, NC = Not Connected.

## ELECTRICAL CHARACTERISTICS

(T<sub>J</sub> = +25°C, I<sub>CHG</sub> = I<sub>DIS</sub> = 200mA, V<sub>BAT</sub> = 3.7V, unless otherwise noted.)

PARAMETER	SYMBOL	CONDITIONS	MIN	TYP	MAX	UNITS
Charge Over-Voltage Threshold	V <sub>OV</sub>	SGM41100V-420_ _ _	T <sub>J</sub> = +25°C	4.180	4.200	4.220
			T <sub>J</sub> = -20°C to +55°C	4.165		4.235
			T <sub>J</sub> = -40°C to +85°C	4.145		4.255
		SGM41100V-423_ _ _	T <sub>J</sub> = +25°C	4.205	4.225	4.245
			T <sub>J</sub> = -20°C to +55°C	4.190		4.260
			T <sub>J</sub> = -40°C to +85°C	4.170		4.280
		SGM41100V425_ _ _	T <sub>J</sub> = +25°C	4.230	4.250	4.270
			T <sub>J</sub> = -20°C to +55°C	4.215		4.285
			T <sub>J</sub> = -40°C to +85°C	4.195		4.305
		SGM41100V-428_ _ _	T <sub>J</sub> = +25°C	4.255	4.275	4.295
			T <sub>J</sub> = -20°C to +55°C	4.240		4.310
			T <sub>J</sub> = -40°C to +85°C	4.220		4.330
		SGM41100V-430_ _ _	T <sub>J</sub> = +25°C	4.280	4.300	4.320
			T <sub>J</sub> = -20°C to +55°C	4.265		4.335
			T <sub>J</sub> = -40°C to +85°C	4.245		4.355
		SGM41100V-433_ _ _	T <sub>J</sub> = +25°C	4.305	4.325	4.345
			T <sub>J</sub> = -20°C to +55°C	4.290		4.360
			T <sub>J</sub> = -40°C to +85°C	4.270		4.380
		SGM41100V-435_ _ _	T <sub>J</sub> = +25°C	4.330	4.350	4.370
			T <sub>J</sub> = -20°C to +55°C	4.315		4.385
			T <sub>J</sub> = -40°C to +85°C	4.295		4.405
		SGM41100V-438_ _ _	T <sub>J</sub> = +25°C	4.355	4.375	4.395
			T <sub>J</sub> = -20°C to +55°C	4.340		4.410
			T <sub>J</sub> = -40°C to +85°C	4.320		4.430
		SGM41100V-440_ _ _	T <sub>J</sub> = +25°C	4.380	4.400	4.420
			T <sub>J</sub> = -20°C to +55°C	4.365		4.435
			T <sub>J</sub> = -40°C to +85°C	4.345		4.455
		SGM41100V-443_ _ _	T <sub>J</sub> = +25°C	4.405	4.425	4.445
			T <sub>J</sub> = -20°C to +55°C	4.390		4.460
			T <sub>J</sub> = -40°C to +85°C	4.370		4.480
		SGM41100V-445_ _ _	T <sub>J</sub> = +25°C	4.430	4.450	4.470
			T <sub>J</sub> = -20°C to +55°C	4.415		4.485
			T <sub>J</sub> = -40°C to +85°C	4.395		4.505
		SGM41100V-448_ _ _	T <sub>J</sub> = +25°C	4.455	4.475	4.495
			T <sub>J</sub> = -20°C to +55°C	4.440		4.510
			T <sub>J</sub> = -40°C to +85°C	4.420		4.530
		SGM41100V-450_ _ _	T <sub>J</sub> = +25°C	4.480	4.500	4.520
			T <sub>J</sub> = -20°C to +55°C	4.465		4.535
			T <sub>J</sub> = -40°C to +85°C	4.445		4.555

## ELECTRICAL CHARACTERISTICS (continued)

(T<sub>J</sub> = +25°C, I<sub>CHG</sub> = I<sub>DIS</sub> = 200mA, V<sub>BAT</sub> = 3.7V, unless otherwise noted.)

PARAMETER	SYMBOL	CONDITIONS	MIN	TYP	MAX	UNITS
Charge Over-Voltage Threshold	V <sub>OV</sub>	SGM41100V-453_ _ _	T <sub>J</sub> = +25°C	4.505	4.525	4.545
			T <sub>J</sub> = -20°C to +55°C	4.490		4.560
			T <sub>J</sub> = -40°C to +85°C	4.470		4.580
		SGM41100V-455_ _ _	T <sub>J</sub> = +25°C	4.530	4.550	4.570
			T <sub>J</sub> = -20°C to +55°C	4.515		4.585
			T <sub>J</sub> = -40°C to +85°C	4.495		4.605
		SGM41100V-458_ _ _	T <sub>J</sub> = +25°C	4.555	4.575	4.595
			T <sub>J</sub> = -20°C to +55°C	4.540		4.610
			T <sub>J</sub> = -40°C to +85°C	4.520		4.630
OV Release Hysteresis	V <sub>OVHYS</sub>	Charger voltage is lower than battery voltage	T <sub>J</sub> = +25°C	100	150	200
			T <sub>J</sub> = -40°C to +85°C	95	205	
Battery Under-Voltage Threshold <sup>(1)</sup>	V <sub>UV</sub>	SGM41100V- _ _ _ M _ _	T <sub>J</sub> = +25°C	2.545	2.600	2.655
			T <sub>J</sub> = -40°C to +85°C	2.515		2.685
		SGM41100V- _ _ _ N _ _	T <sub>J</sub> = +25°C	2.645	2.700	2.755
			T <sub>J</sub> = -40°C to +85°C	2.615		2.785
		SGM41100V- _ _ _ O _ _	T <sub>J</sub> = +25°C	2.745	2.800	2.855
			T <sub>J</sub> = -40°C to +85°C	2.715		2.885
		SGM41100V- _ _ _ P _ _	T <sub>J</sub> = +25°C	2.945	3.000	3.055
			T <sub>J</sub> = -40°C to +85°C	2.915		3.085
UV Release Hysteresis	V <sub>UVHYS</sub>	When a charging supply is applied	T <sub>J</sub> = +25°C	75	100	125
			T <sub>J</sub> = -40°C to +85°C	70	130	
Shutdown Voltage	V <sub>SHDN</sub>	T <sub>J</sub> = +25°C	1.40	1.67	1.95	
		T <sub>J</sub> = -40°C to +85°C	1.18		2.15	
Charging Prohibition Voltage <sup>(1)</sup>	V <sub>NOCHG</sub>	T <sub>J</sub> = +25°C	2.43	2.5	2.57	
		T <sub>J</sub> = -40°C to +85°C	2.40		2.60	
Discharge Over-Current	I <sub>OD</sub>	SGM41100V- _ _ _ _ 01	T <sub>J</sub> = +25°C	0.140	0.169	0.200
			T <sub>J</sub> = -40°C to +85°C	0.105		0.235
		SGM41100V- _ _ _ _ 02	T <sub>J</sub> = +25°C	0.270	0.300	0.330
			T <sub>J</sub> = -40°C to +85°C	0.225		0.375
		SGM41100V- _ _ _ _ 04	T <sub>J</sub> = +25°C	0.500	0.560	0.620
			T <sub>J</sub> = -40°C to +85°C	0.435		0.685
Charge Over-Current	I <sub>OC</sub>	SGM41100V- _ _ _ _ 01	T <sub>J</sub> = +25°C	0.130	0.156	0.200
			T <sub>J</sub> = -40°C to +85°C	0.100		0.225
		SGM41100V- _ _ _ _ 02	T <sub>J</sub> = +25°C	0.165	0.190	0.215
			T <sub>J</sub> = -40°C to +85°C	0.120		0.260
		SGM41100V- _ _ _ _ 04	T <sub>J</sub> = +25°C	0.310	0.350	0.390
			T <sub>J</sub> = -40°C to +85°C	0.250		0.450

**ELECTRICAL CHARACTERISTICS (continued)**(T<sub>J</sub> = +25°C, I<sub>CHG</sub> = I<sub>DIS</sub> = 200mA, V<sub>BAT</sub> = 3.7V, unless otherwise noted.)

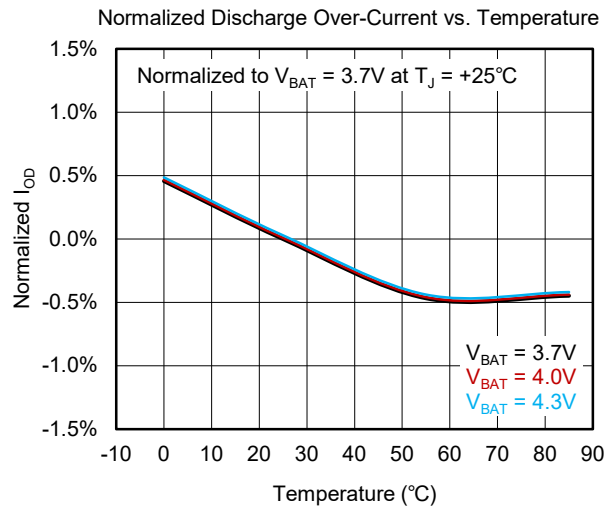
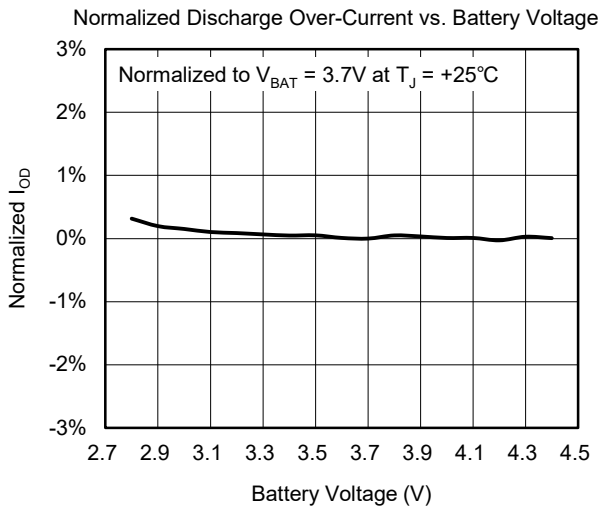
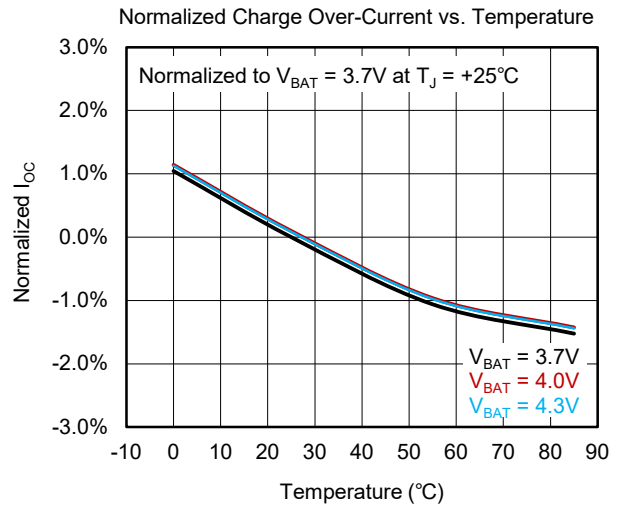
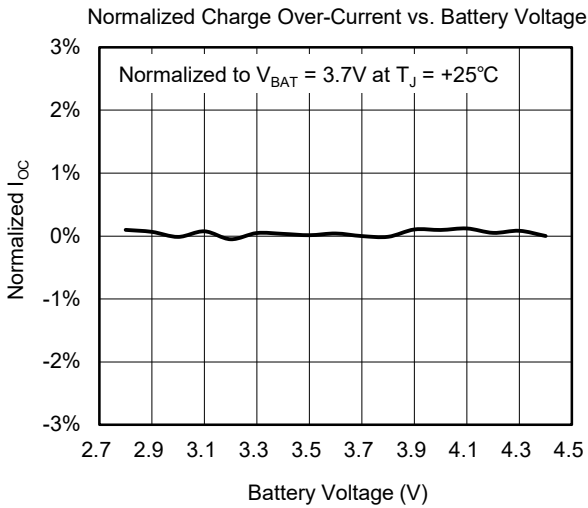
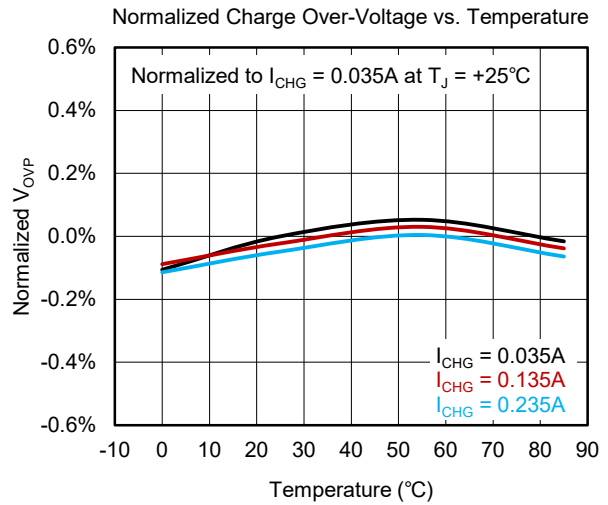
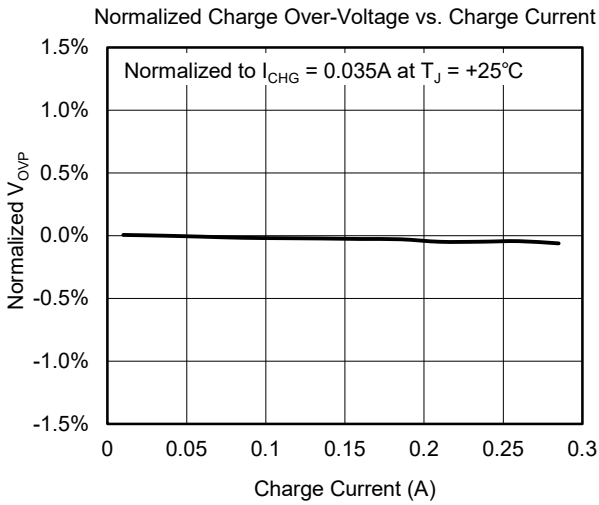
PARAMETER	SYMBOL	CONDITIONS	MIN	TYP	MAX	UNITS
Pass Resistance	R <sub>P</sub>	T <sub>J</sub> = +25°C		42	52	mΩ
		T <sub>J</sub> = -40°C to +85°C			62	
Operating Current	I <sub>OP</sub>	T <sub>J</sub> = +25°C		1.1	1.5	μA
		T <sub>J</sub> = -40°C to +85°C			2.0	
Shutdown Current	I <sub>SHDN</sub>	The stable current flowing into the device when it is in any of following shutdown conditions that the battery voltage is lower than V <sub>UV</sub> (then V <sub>SHDN</sub> , V <sub>NOCHG</sub> if the battery voltage further drops), the device is set into latched-off	T <sub>J</sub> = +25°C		0.05	μA
		T <sub>J</sub> = -40°C to +85°C		0.30		
Over-Voltage Detection Delay <sup>(2)</sup>	t <sub>OVPD</sub>	T <sub>J</sub> = +25°C	923	1066	1209	ms
		T <sub>J</sub> = -40°C to +85°C	537		1342	
Under-Voltage Detection Delay <sup>(2)</sup>	t <sub>UVPD</sub>	T <sub>J</sub> = +25°C	115	144	188	ms
		T <sub>J</sub> = -40°C to +85°C	67		208	
Discharge Over-Current Detection Delay <sup>(2)</sup>	t <sub>ODD</sub>	T <sub>J</sub> = +25°C	57	80	113	ms
		T <sub>J</sub> = -40°C to +85°C	33		125	
Discharge Over-Current Retry Time <sup>(2)</sup>	t <sub>RETRY</sub>	T <sub>J</sub> = +25°C	461	528	609	ms
		T <sub>J</sub> = -40°C to +85°C	268		676	
Charge Over-Current Detection Delay <sup>(2)</sup>	t <sub>OCD</sub>	T <sub>J</sub> = +25°C	57	80	113	ms
		T <sub>J</sub> = -40°C to +85°C	33		125	
Discharge Short-Circuit Detection Delay	t <sub>OCS</sub>	T <sub>J</sub> = +25°C	0.196	0.3	0.5	ms
		T <sub>J</sub> = -40°C to +85°C	0.14		0.7	
Discharge Short-Circuit Current	I <sub>SC</sub>			4 × I <sub>OD</sub>		A

## NOTES:

- V<sub>UV</sub> and V<sub>SHDN</sub> variation seat in the same side deviation and no range overlaps.
- The TYP value and MAX value are combination of the detection delay time and a possible polling period of about 32ms, while the MIN value represents the minimum detection delay with portion of a polling period added, as the pass path cutting action is synchronized to the internal polling.

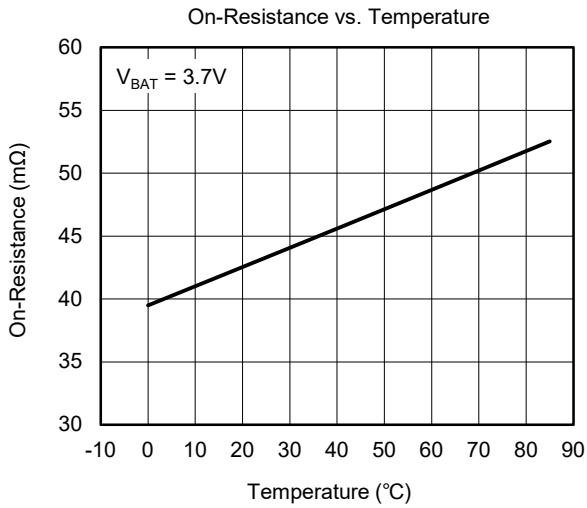
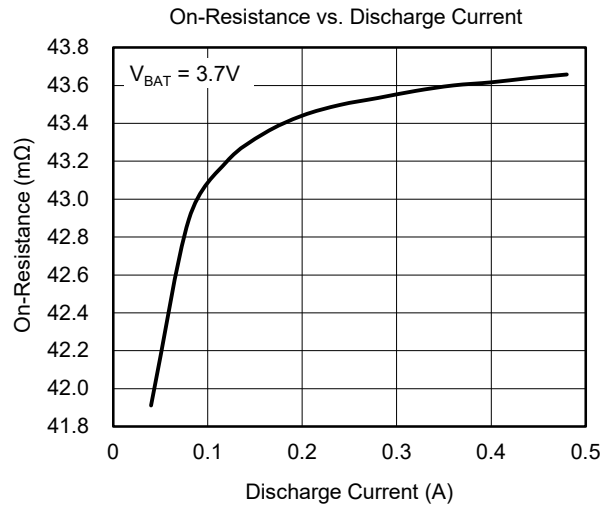
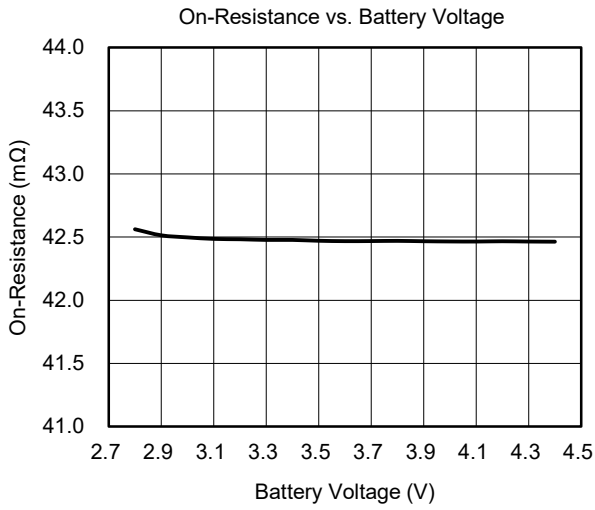
TYPICAL PERFORMANCE CHARACTERISTICS

T<sub>J</sub> = +25°C, I<sub>CHG</sub> = I<sub>DIS</sub> = 50mA, V<sub>BAT</sub> = 3.7V, unless otherwise noted.



**TYPICAL PERFORMANCE CHARACTERISTICS (continued)**

$T_J = +25^\circ\text{C}$ ,  $I_{\text{CHG}} = I_{\text{DIS}} = 50\text{mA}$ ,  $V_{\text{BAT}} = 3.7\text{V}$ , unless otherwise noted.





## DETAILED DESCRIPTION

The SGM41100V monitors voltage and current applied on battery cell connected between PCKP and BATN, and opens the connection between battery and pack terminal with its internal switches when a fault condition is detected.

### Voltage Related Protections

When battery voltage reaches over-voltage threshold ( $V_{OV}$ ), the charge path is open-circuit. The path closes again when the charger voltage is lower than battery voltage and the battery voltage falls back about  $V_{OVHYS}$  below the over-voltage threshold ( $V_{OV}$ ).

In order to protect the battery from discharge under-voltage status when battery voltage falls below  $V_{UV}$  for  $t_{UVPD}$  or  $V_{SHDN}$  instantly, the discharge path is open-circuit, the device enters into shutdown with only very low resistive leakage flowing into it, which helps to keep the battery from harmful exhausted condition as long as possible. The path closes again when a charging supply is applied and the battery voltage rises to about  $V_{UVHYS}$  above the  $V_{UV}$  threshold.

**Charge an exhausted battery:** While the battery is over-discharged the battery could be in the following states.

- Battery voltage below  $V_{NOCHG}$ : The charge path or discharge path is open correspondingly when the applied bias condition is settled.
- Battery voltage is in the range of  $V_{NOCHG}$  to  $V_{UV}$  (if there is such voltage gap): The path switch is on for 144ms ( $t_{UVPD}$ ) in every 132ms and off for 2ms when charge current flows through the body diode. During this period, the charger will see the terminal voltage steps up/down.
- Battery voltage above under-voltage threshold: In this condition, the chip enters normal operation and charge and discharge modes are allowed.

When battery voltage is between  $V_{SHDN}$  and  $V_{NOCHG}$ , there is about 150 $\mu$ s circuit settle time when a pulse charge current may flow through.

When the battery voltage is in the range of 0.5V ~ 0.7V, and the external voltage applied on the device is also too low to start full operation, the charging current flows through the path switch's body diode.

### Current Related Protections

When discharge over-current condition occurs and keeps for discharge over-current detection delay ( $t_{ODD}$ ), the discharge path opens. The path closes again after  $t_{RETRY}$  for retrying. The SGM41100V keeps retrying until the over-current condition is released or the battery discharges to low when the SGM41100V turns into battery under-voltage protection state.

During a charging condition if a charge over-current is identified, the SGM41100V enters the locked-off state. This state can be reset by charger removal (pack removal).

**Short-circuit protection:** When discharge current exceeds the over-current threshold, discharge path disconnects instantly in  $t_{OCS}$ , in order to protect the battery from potential over-current stress. After this disconnection, the SGM41100V stays in the locked-off non-conducting state until being reactivated.

**Burst load outrush:** In many systems, overload conditions will occur momentarily. The device allows for this short duration discharge condition by allowing the discharge path to remain closed even after a discharge over-current is detected for duration of discharge over-current detection delay.

When a charge over-current condition is identified, and after charge over-current detection deglitch, the charge path is cut off. The device restores to the conducting state when the PCKP to PCKN voltage drops about 3mV lower than the battery voltage.

**Parallel battery packs:** When paralleling two battery packs utilizing SGM41100Vs, a momentary current surge may cause charge over-current protection in the pack with the lower voltage. The higher voltage pack can enter a discharge over-current protection. The charge over-current or discharge over-current protection resets only after the higher voltage battery pack discharges to a voltage slightly lower than the lower voltage pack. After this discharge, both packs will conduct.

## DETAILED DESCRIPTION (continued)

It is highly recommended that the packs should be placed into a locked-open non-conducting state first (by connecting PCKP to PCKN momentarily) before being paralleled to avoid current overstress. When a charge supply is applied to the paralleled packs, the locked-open state will release.

**Battery delivery state:** It is recommended to deliver a battery pack in a locked-off non-conducting state to avoid unintentional shorting during production handling or transportation. The circuit of Figure 1 places the SGM41100V into a locked-off state after battery attachment by momentarily shorting BYPS and PCKN.

**Pack activation:** In order to release the pack from locked-off state and to place it into a conducting state, apply a charging input, or connect PCKN to BATN momentarily.

**Caution:** The battery short or load side terminal short outside the protection circuit's loop during battery attaching may cause excessive high surge current and excessive high current-breaking voltage surge, which may cause damage or degrade the life duration of battery and protection circuit. It is recorded that the accidental anode to ground plane shorting causes heavy surge, which can actually be avoided by leaving enough clearance around the anode pad on PCB or soldering/attaching the anode firstly in assembly (as the short between cathode to ground will not cause excessive surge).

### Surge, ESD and Reversed Attachment

The SGM41100V absorbs voltage surge applied between PCKP and PCKN, by passing the surge current through its switch and the battery. Surge may occur when attaching the pack or battery cell.

The SGM41100V survives either if a cell is placed in reverse or a charge input is attached in reverse, but not both at the same time. Any of these reverse attachments, short circuits, inrush surges and outrush will cause overstress. Do not test those cases in normal production inspection, as this kind of test itself may cause performance degradation or even damage the device.

**Caution about ESD damage to the battery:** The battery pack might be the biggest element in equipment and induce much during an ESD event. Careful design

of guided discharge path is desired for the equipment case sealing air-gap discharge over the battery and those connect to the battery closely.

**Caution on electrochemical corrosion:** As a battery can apply potential over the electrodes continuously and cause electrochemical corrosion, the corrosion product may spread in the hollow beneath a surface mount device and cause leakage. Moisture-proof coating is recommended, especially when using compact devices.

### Cautions for Evaluation Test

Some types of electronic load simulators may have excessive inrush current, and some BPM testers may have voltage transition surges, which may trigger the protection of the SGM41100V. Careful attention is required for doing such evaluations with these kinds of equipment. External voltage and current limits within the conditions specified in the Absolute Maximum Ratings section of this datasheet are required.

### Select Protection Parameters

Battery models from different vendors may be customized for different applications. Consult the battery vendor for protection limits for specific battery model.

Parameters for the protection circuit and of the charger circuit affecting same variables should be set for proper charge or discharge protection sequence. For example, the over-voltage threshold of the battery should be 50mV ~ 100mV higher than constant voltage threshold of the charger.

**Cautions on parameter misalignment:** If the  $V_{OV}$  is lower than the full charge voltage of the battery charger, the protection circuit cuts off the battery charge path before the battery is fully charged, and turns into the non-conductive locked-off state; if the  $I_{OC}$  is lower than the charge current, the protection circuit also turns itself into the locked-off state. In either  $V_{OV}$  or  $I_{OC}$ , the charger input should be removed and then reapplied for activating the protection circuit from the locked-off state to the conducting state. If the charger is not removed after a  $V_{OV}$  or  $I_{OV}$  event, the battery will not be charged even if the battery voltage is depleted.

**REVISION HISTORY**

NOTE: Page numbers for previous revisions may differ from page numbers in the current version.

<b>SEPTEMBER 2021 – REV.A to REV.A.1</b>	<b>Page</b>
Updated Electrical Characteristics section .....	14

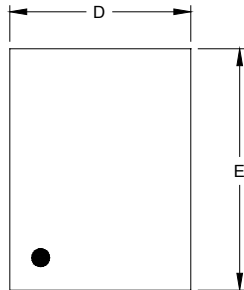
---

<b>Changes from Original (APRIL 2021) to REV.A</b>	<b>Page</b>
Changed from product preview to production data.....	All

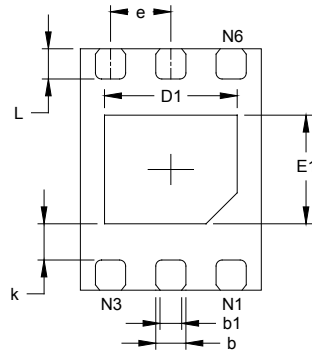
---

PACKAGE OUTLINE DIMENSIONS

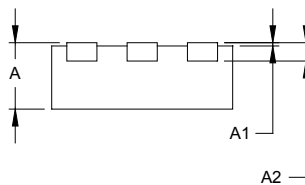
UTDFN-1.5×2-6L



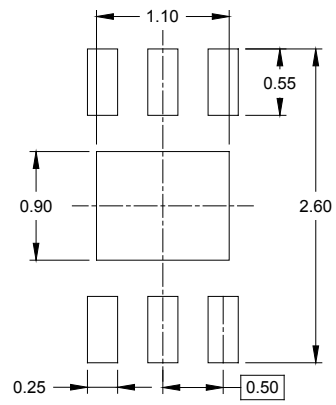
TOP VIEW



BOTTOM VIEW



SIDE VIEW



RECOMMENDED LAND PATTERN (Unit: mm)

Symbol	Dimensions In Millimeters		Dimensions In Inches	
	MIN	MAX	MIN	MAX
A	0.500	0.600	0.020	0.024
A1	0.000	0.050	0.000	0.002
A2	0.152 REF		0.006 REF	
D	1.400	1.600	0.055	0.063
D1	1.000	1.200	0.039	0.047
E	1.900	2.100	0.075	0.083
E1	0.800	1.000	0.031	0.039
k	0.300 REF		0.012 REF	
b	0.200	0.300	0.008	0.012
b1	0.180 REF		0.007 REF	
e	0.500 BSC		0.020 BSC	
L	0.200	0.300	0.008	0.012

# PACKAGE INFORMATION

## TAPE AND REEL INFORMATION

### REEL DIMENSIONS



### TAPE DIMENSIONS



NOTE: The picture is only for reference. Please make the object as the standard.

### KEY PARAMETER LIST OF TAPE AND REEL

Package Type	Reel Diameter	Reel Width W1 (mm)	A0 (mm)	B0 (mm)	K0 (mm)	P0 (mm)	P1 (mm)	P2 (mm)	W (mm)	Pin1 Quadrant
UTDFN-1.5×2-6L	7"	9.5	1.70	2.30	0.75	4.0	4.0	2.0	8.0	Q2

000001

# PACKAGE INFORMATION

## CARTON BOX DIMENSIONS



NOTE: The picture is only for reference. Please make the object as the standard.

## KEY PARAMETER LIST OF CARTON BOX

Reel Type	Length (mm)	Width (mm)	Height (mm)	Pizza/Carton
7" (Option)	368	227	224	8
7"	442	410	224	18

DD0002