

## SMD type common-mode choke coil

PLT5BPH□□□□□□SN□

Murata Standard Reference Specification [AEC-Q200]

### 1. Scope

This reference specification applies to SMD type Common Mode Choke Coil PLT5BPH Series for Automotive Electronics based on AEC-Q200.

### 2. Part Numbering

(ex.) PLT 5BP H 101 5R6 S N L

Product ID Type Application Common Mode Impedance Zc Rated Current Winding Mode Dimension Packaging code

H : Automotive

L : Taping (Φ180mm reel)  
B : Bulk

### 3. Rating

Customer Part Number	MURATA Part Number	Common Mode Impedance Zc (at10MHz) (Ω)		Rated Voltage V(DC)	Withstand Voltage V(DC)	* Rated Current (A)		DC Resistance (Rdc) (mΩ±30%)	Insulation Resistance (I.R.) (MΩmin.)	ESD Rank 2.2kV
		Typ.	Min.			125°C	150°C			
	PLT5BPH1015R6SNL	100	60	80	200	5.6	2.9	4	10	2
	PLT5BPH1015R6SNB					4.4	2.4			
	PLT5BPH2014R4SNL	200	120			3.7	2.2	11		
	PLT5BPH2014R4SNB					3.1	1.8			
	PLT5BPH3013R7SNL	300	180			3.7	2.2	11		
	PLT5BPH3013R7SNB					3.1	1.8			
	PLT5BPH5013R1SNL	500	300			3.1	1.8	17		
	PLT5BPH5013R1SNB					3.1	1.8			

Operating Temperature range : -55°C~+150°C

Storage Temperature range : -55°C~+150°C

■ \* Rated Current is derated as below figure depending on the operating temperature.

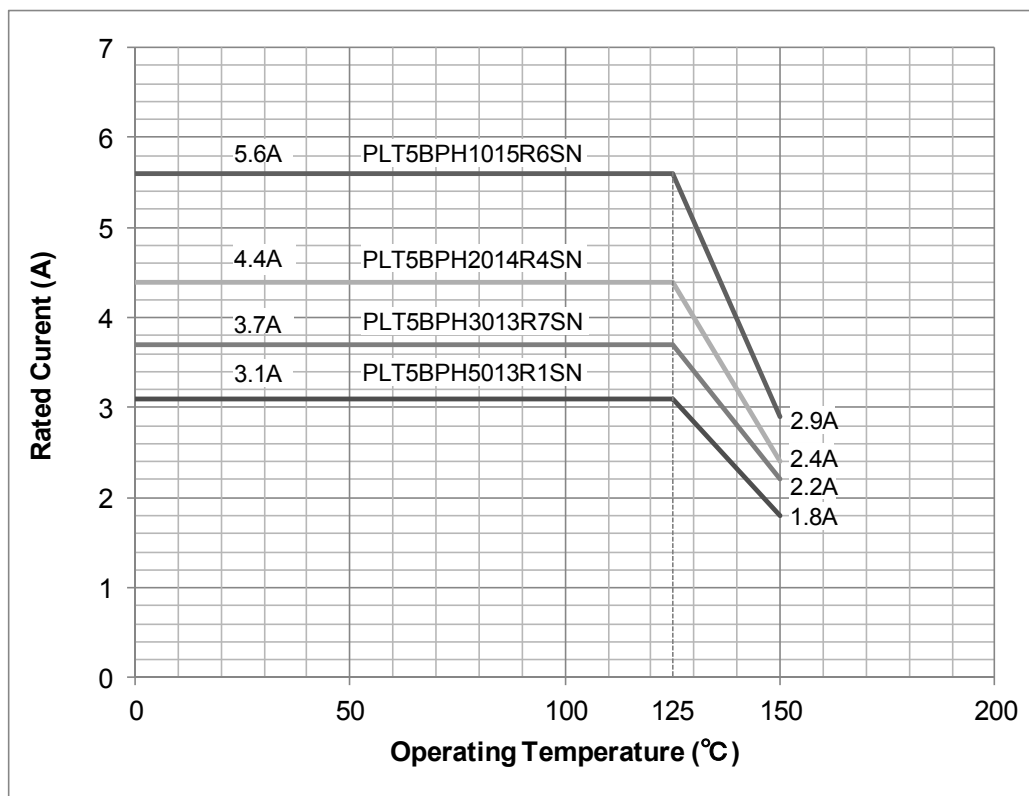

### 4. Standard Testing Conditions

< Unless otherwise specified >

Temperature: Ordinary Temp. 15 °C to 35 °C

Humidity: Ordinary Humidity 25 %(RH) to 85 %(RH)

< In case of doubt >

Temperature: 20 °C ± 2 °C

Humidity: 60 %(RH) to 70 %(RH)

Atmospheric pressure: 86 kPa to 106 kPa

### 5. Style and Dimensions

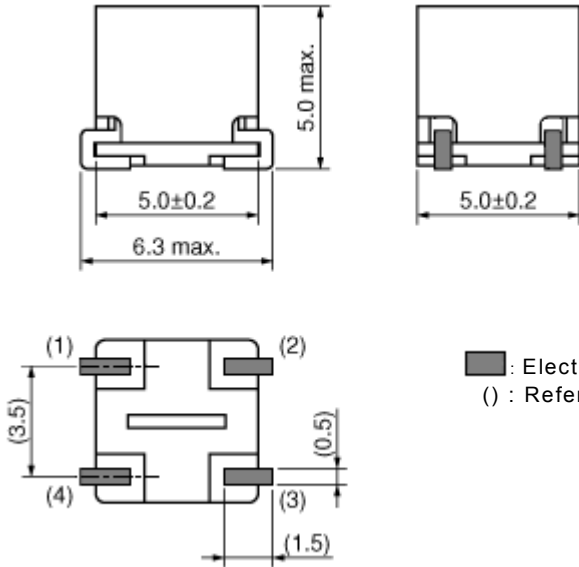

■ : Electrode  
 ( ) : Reference Value  
 (in:mm)

#### ■ Equivalent Circuit

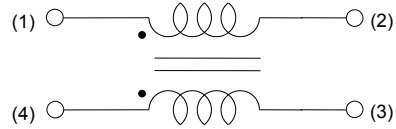

No Polarity

#### ■ Unit Mass (Typical value)

0.48g

### 6. Marking

No Marking.

### 7. Electrical Performance

No.	Item	Specification	Test method
7.1	Common Mode Impedance (Zc) Typ.	Meet item 3	Measuring Equipment: KEYSIGHT 4991A or the equivalent Measuring Frequency: 10MHz (ref.item 9)
7.2	Insulation Resistance (I.R.)		Measuring Voltage: Rated Voltage Time: within 1min. (ref.item 9)
7.3	Withstand Voltage V(DC)	Products shall not be damaged.	Voltage: Rated Voltage×2.5 Time: 1~5s. Measuring current: 1mA max. (ref.item 9)
7.4	DC Resistance (Rdc)	Meet item 3	Measuring Current : 100mA (ref.item 9) (In case of doubt in the above mentioned standard condition,measure by 4 terminal method.)

**8. Q200 Requirement**

**8-1. Performance (based on Table 13 for Ferrite EMI SUPPRESSORS/FILTERS)**

**AEC-Q200 Rev.D issued June 1. 2010**

AEC-Q200			Murata Specification / Deviation						
No	Stress	Test Method							
3	High Temperature Exposure	1000hours at +150 deg C Set for 24hours at room temperature, then measured.	Meet Table A after testing. Table A <table border="1" style="margin-left: 20px; border-collapse: collapse;"> <tr> <td style="text-align: center;">Appearance</td> <td style="text-align: center;">No damage</td> </tr> <tr> <td style="text-align: center;">Common Mode Impedance (% Δ Zc)</td> <td style="text-align: center;">within ±15%</td> </tr> <tr> <td style="text-align: center;">Insulation Resistance (I.R.)</td> <td style="text-align: center;">Meet item 3</td> </tr> </table>	Appearance	No damage	Common Mode Impedance (% Δ Zc)	within ±15%	Insulation Resistance (I.R.)	Meet item 3
Appearance	No damage								
Common Mode Impedance (% Δ Zc)	within ±15%								
Insulation Resistance (I.R.)	Meet item 3								
4	Temperature Cycling	1000cycles -55 deg C to +150 deg C Set for 24hours at room temperature, then measured.	Meet Table A after testing.						
5	Destructive Physical Analysis	Per EIA469 No electrical tests	Not Applicable						
7	Biased Humidity	1000hours at 85 deg C, 85%RH Apply max rated voltage and current.	Meet Table A after testing. Apply rated voltage. <span style="float: right;">(ref.item 9.2)</span>						
8	Operational Life	Apply 150 deg C 1000hours Set for 24hours at room temperature, then measured.	Meet Table A after testing. Apply rated current. <span style="float: right;">(ref.item 9.2)</span>						
9	External Visual	Visual inspection	No abnormalities						
10	Physical Dimension	Meet ITEM 4 (Style and Dimensions)	No defects						
12	Resistance to Solvents	Per MIL-STD-202 Method 215	Not Applicable						
13	Mechanical Shock	Per MIL-STD-202 Method 213 Condition F: 1500g's(14.7N)/0.5ms/ Half sine	Meet Table A after testing.						
14	Vibration	5g's(0.049N) for 20 minutes, 12cycles each of 3 orientations Test from 10-2000Hz. 12cycles each of 3 orientations	Meet Table A after testing.						
15	Resistance to Soldering Heat	No-heating Solder temperature 260C+/-5 deg C Immersion time 10s	Pre-heating : 150 to 180C / 90±30s Meet Table A after testing.						
17	ESD	Per AEC-Q200-002	Meet Table A after testing. ESD Rank: Refer to Item 3. Rating.						
18	Solderability	Per J-STD-002	Method b : Not Applicable 90% of the terminations is to be soldered. (except partly-exposed wire) Flux:Ethanol solution of rosin,25(wt)% includes activator equivalent to 0.06 to 0.10(wt)% chlorine						
19	Electrical Characterization	Measured : Impedance	No defects.						
20	Flammability	Per UL-94	Not Applicable						
21	Board Flex	Epoxy-PCB(1.6mm) Deflection 2mm(min) 60 sec minimum holding time	Meet Table A after testing.						
22	Terminal Strength	Per AEC-Q200-006 A force of 17.7N for 60sec	No defects						
30	Electrical Transient Conduction	Per ISO-7637-2	Not Applicable						

### 9. Measuring Terminal

(When measuring and supplying the voltage, the following terminal is applied.)

No.	Item	Measuring terminal
9.1	Common Mode Impedance(Zc)	
9.2	Withstand voltage Insulation Resistance (I.R.) Humidity life Operational Life	
9.3	DC Resistance (Rdc)	

### 10. Measuring method for common mode impedance.

Measured common mode impedance may be included measurement error due to stray capacitance, residual inductance of test fixture.

To correct this error, the common mode impedance should be calculate as follows;

- (1) Measure admittance of the fixture(opened),  $G_o$   $B_o$ .
- (2) Measure impedance of the fixture(shorted),  $R_s$   $X_s$ .
- (3) Measure admittance of the specimen,  $G_m$   $B_m$ .
- (4) Calculate corrected impedance  $|Z|$  using the formula below.

$$|Z| = (R_x^2 + X_x^2)^{1/2}$$

Where

$$R_x = \frac{G_m - G_o}{(G_m - G_o)^2 + (B_m - B_o)^2} - R_s$$

$$X_x = \frac{-(B_m - B_o)}{(G_m - G_o)^2 + (B_m - B_o)^2} - X_s$$

### 11. P.C.B., Flux, Solder and Soldering condition

Test shall be done using P.C.B., Flux, Solder and Soldering condition which are specified in item 15 except the case of being specified special condition.

### 12. Common Mode Impedance (Zc) frequency characteristics (typical)

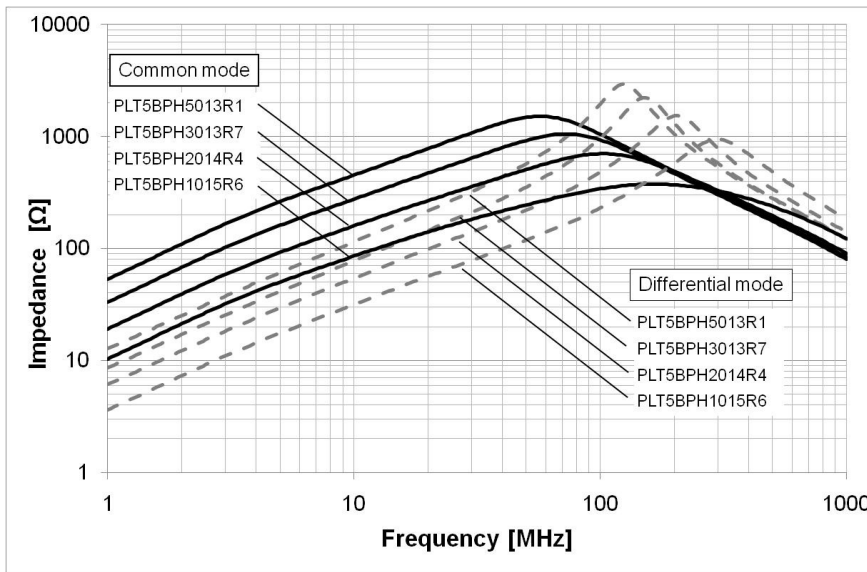

### 13. Specification of Packaging

#### 13.1 Appearance and Dimensions (12mm-wide, Plastic tape)

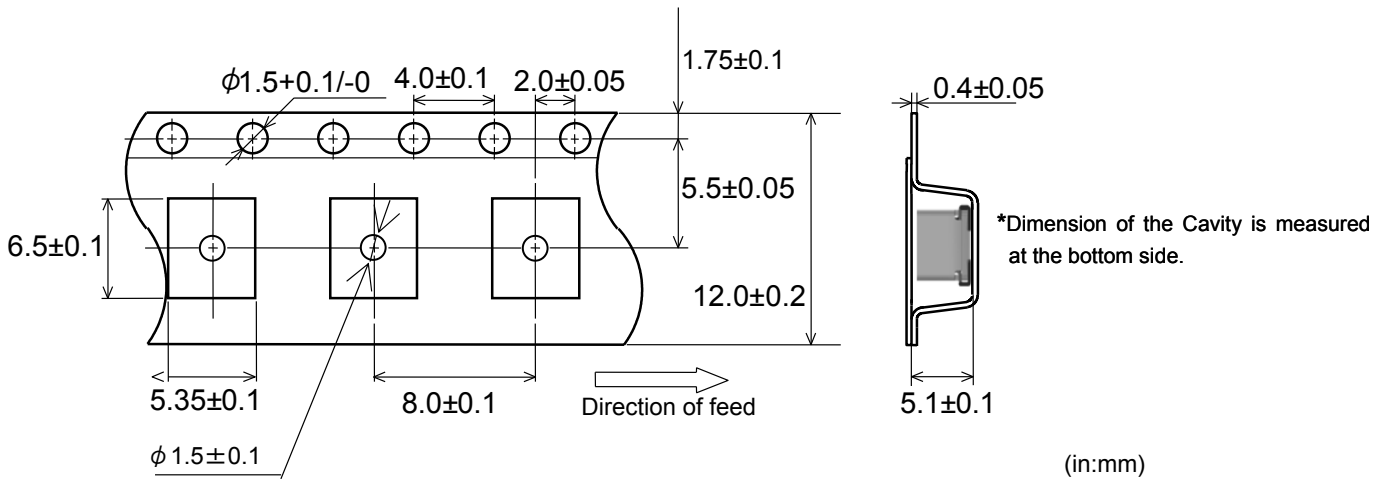

#### 13.2 Specification of Taping

- (1) Packing quantity (Standard quantity)  
 $\Phi 180$  mm reel: 300pcs. / reel
- (2) Packing Method  
 Products shall be packaged in each embossed cavity of plastic tape and sealed with cover tape.
- (3) Sprocket Hole  
 The sprocket holes are to the right as the tape is pulled toward the user.
- (4) Spliced point  
 The cover tape has no spliced point.
- (5) Missing components number  
 Missing components number within 0.1% of the number per reel or 1 pc., whichever is greater, and are not continuous. The specified quantity per reel is kept.

#### 13.3 Pull Strength of Cover Tape

Plastic Tape	5 N min.
Cover Tape	10 N min.

#### 13.4 Peeling off force of Cover Tape

0.2N to 0.7N (minimum value is typical.)  
 Speed of Peeling off: 300 mm / min

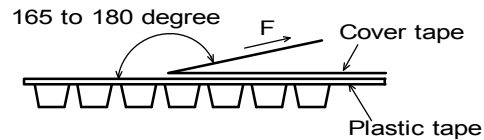

#### 13.5 Dimensions of Leader-tape, Trailer and Reel

【Packaging code : L ( $\Phi 180$ mm reel)】

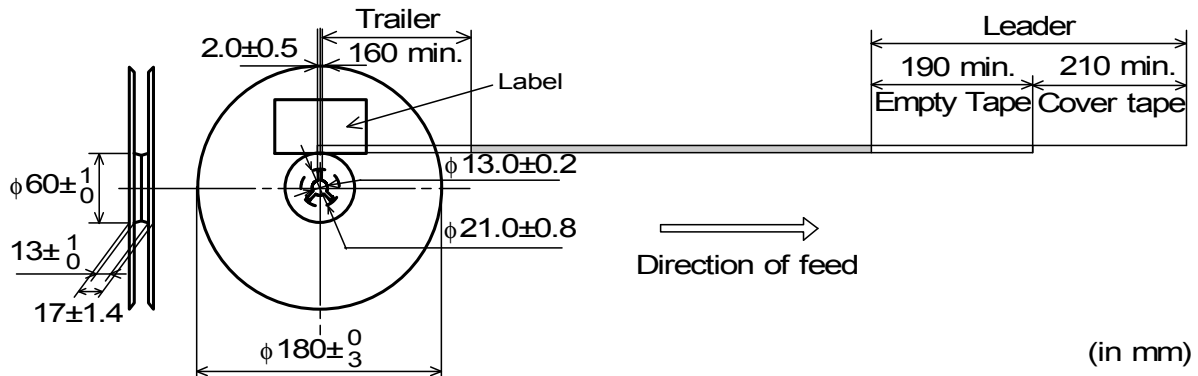

(in mm)

### 13.6 Marking for reel

Customer part number, MURATA part number, Inspection number(\*1), RoHS Marking(\*2), Quantity, etc

\*1) < Expression of Inspection No. > □□ ○○○○ ◇◇◇◇

- ① Factory code
- ② Date      First digit : year / Last digit of year  
                   Second digit : Month / Jan. to Sep. → 1 to 9, Oct. to Dec. → O, N, D  
                   Third, Fourth digit : Day
- ③ Serial No.

\*2) < Expression of RoHS Marking >      ROHS - Y (△)

- ① RoHS regulation conformity parts
- ② MURATA classification number

### 13.7 Marking for Outside package

Customer name, Purchasing Order Number, Customer Part Number, MURATA part number, RoHS Marking (\*2), Quantity, etc

### 13.8 Specification of Outer Case

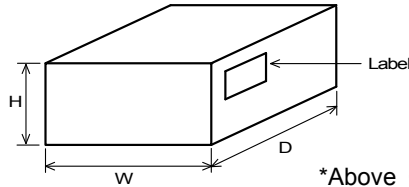

Reel	Outer case Dimensions (mm)			Standard Reel Quantity in Outer case (Reel)
	W	D	H	
Φ180mm	186	186	93	4

\*Above Outer Case size is typical. It depends on a quantity of an order.

## 14. ⚠Caution

### 14.1 Mounting Direction

Mount products in right direction.

Wrong direction which is 90° rotated from right direction causes not only open or short circuit but also flames or other serious trouble.

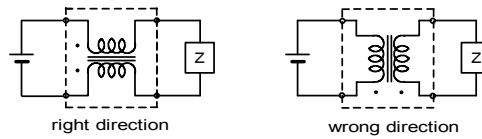

### 14.2 Limitation of Applications

Please contact us before using our products for the applications listed below which require especially high reliability for the prevention of defects which might directly cause damage to the third party's life, body or property.

- (1) Aircraft equipment
- (2) Aerospace equipment
- (3) Undersea equipment
- (4) Power plant control equipment
- (5) Medical equipment
- (6) Transportation equipment (trains, ships, etc.)
- (7) Traffic signal equipment
- (8) Disaster prevention / crime prevention equipment
- (9) Data-processing equipment
- (10) Applications of similar complexity and /or reliability requirements to the applications listed in the above

### 14.3 Caution(Rating)

Do not exceed maximum rated current of the product. Thermal stress may be transmitted to the product and short/open circuit of the product or falling off the product may be occurred.

### 14.4 Fail Safe

Be sure to provide an appropriate fail-safe function on your product to prevent from a second damage that may be caused by the abnormal function or the failure of our products.

### 14.5 Attention regarding product's heat generation

Please pay special attention to the product's heat generation such as beyond Operating Temperature range, mounting product in close proximity to other products that radiate heat and beyond the rated current.

## 15. Notice

Products can only be soldered with reflow.

This product is designed for solder mounting.

Please consult us in advance for applying other mounting method such as conductive adhesive.

### 15.1 Flux and Solder

Flux	Use rosin-based flux. (with Halogen content exceeding 0.2(wt)% conversion to chlorine). Do not use water-soluble flux.
Solder	Use Sn-3.0Ag-0.5Cu solder

### 15.2 Notes for Assembling

<Exclusive Use of Reflow Soldering>

When installing by the flow soldering, the degradation of the insulation resistance sometimes occurs.

Products can only be soldered with reflow.

The use in flow soldering is reserved.

### 15.3 Cleaning Conditions

Do not clean after soldering. If cleaning, please contact us.

### 15.4 Attention Regarding P.C.B. Bending

The following shall be considered when designing P.C.B.'s and laying out products.

(1) P.C.B. shall be designed so that products are not subject to the mechanical stress for board warpage.

[ Products Direction]

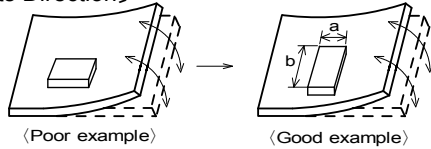

Products shall be located in the sideways direction (Length:  $a < b$ ) to the mechanical stress.

(2) Products location on P.C.B. near seam for separation.

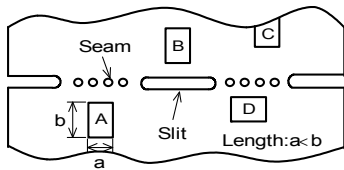

Products (A,B,C,D) shall be located carefully so that products are not subject to the mechanical stress due to warping the board. Because they may be subjected the mechanical stress in order of  $A > C > B \cong D$ .

### 15.5 Attention Regarding P.C.B. Design

< The Arrangement of Products >

P.C.B. shall be designed so that products are far from the portion of perforation.

The portion of perforation shall be designed as narrow as possible, and shall be designed so as not to be applied the stress in the case of P.C.B. separation.

Products shall not be arranged on the line of a series of holes when there are big holes in P.C.B. (Because the stress concentrates on the line of holes.)

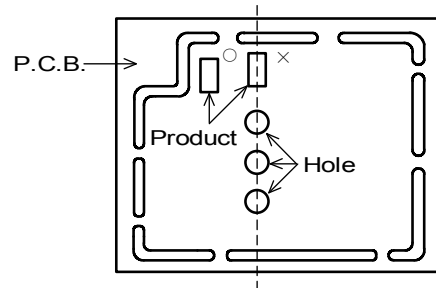
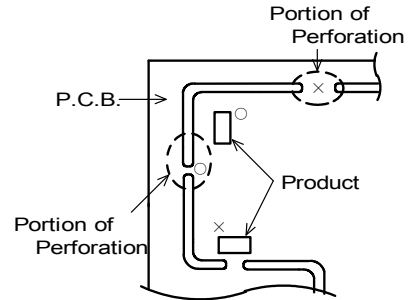

< At 2nd reflow soldering process >

At 2nd reflow soldering process, the product mounted on PCB might be dropped off due to its weight.

Please take care for preventing the dropping off.

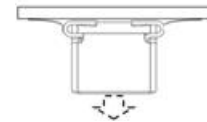

Under surface

< Products Placing >

Support pins shall be set under P.C.B. to prevent causing a warp to P.C.B. during placing the products on the otherside of P.C.B.

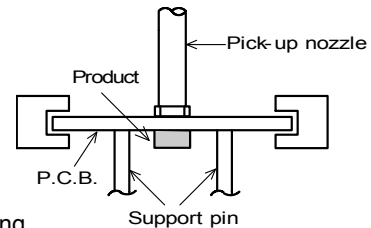

< P.C.B. Separation >

P.C.B. shall not be separated with hand.

P.C.B. shall be separated with the fixture so as not to cause P.C.B. bending.

## 15.6 Standard Land Dimensions

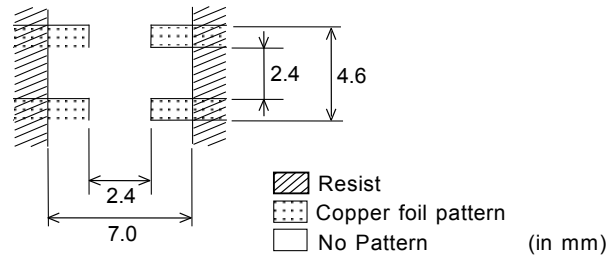

## 15.7 Standard Soldering Condition

### 1.Reflow Soldering

#### (1) Soldering conditions

- Pre-heating should be in such a way that the temperature difference between solder and ferrite surface is limited to 150°C max. Also cooling into solvent after soldering should be in such a way that the temperature difference is limited to 100°C max.

Insufficient pre-heating may cause cracks on the ferrite, resulting in the deterioration of product quality.

- Standard soldering profile and the limit soldering profile is as follows.

The excessive limit soldering conditions may cause leaching of the electrode and / or resulting in the deterioration of product quality.

#### (2) Soldering Conditions

Standard soldering profile and the limit soldering profile is as follows.

The excessive limit soldering conditions may cause leaching of the electrode and / or resulting in the deterioration of product quality.

- Soldering Profile for Lead Free solder (Sn-3.0Ag-0.5Cu solder )

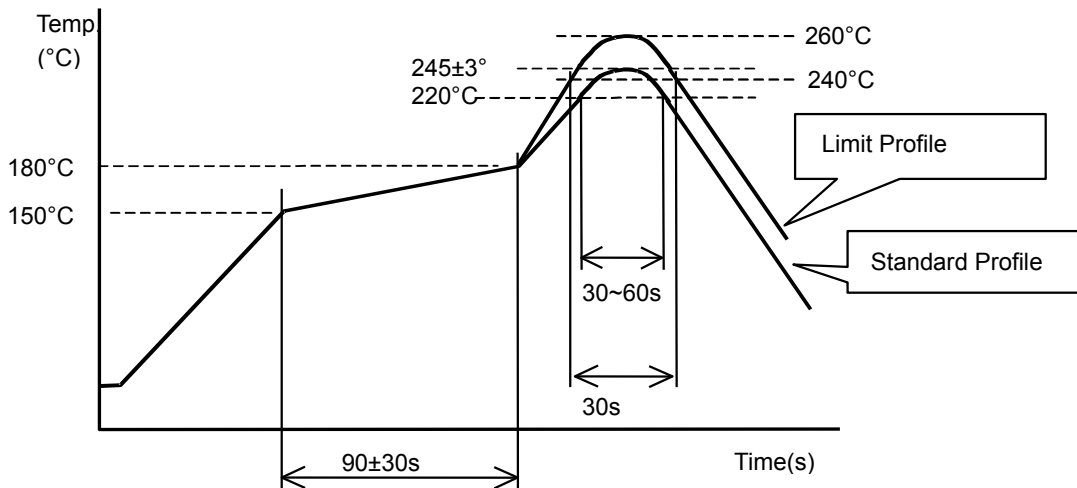

	Standard Profile	Limit Profile
Pre-heating	150°C ~ 180°C , 90s ± 30s	
Heating	above 220°C , 30s ~ 60s	above 240°C , 30s max.
Peak temperature	245°C ± 3°C	260°C , 10s
Cycle of reflow	2 times	2 times

### 2. Solder paste printing for reflow soldering

- Standard thickness of solder paste should be 150 μm.

Incidentally, depending on the reflow condition and the way of heat conduction, the solder would not wet up the terminal, being possible to lead to not enough connection between terminals and lands on the circuit board / open circuit in the circuit board. In case of use, always evaluate this part in your products with actual use condition.

- For the solder paste printing pattern, use standard land dimensions.
- For the resist and copper foil pattern, use standard land dimensions.
- Use Sn-3.0Ag-0.5Cu solder

### 3. Reworking with Soldering iron

- The following conditions shall be strictly followed when using a soldering iron.
  - Pre-heating: 150°C, 1 min
  - Soldering iron output: 30W max.
  - Tip temperature: 350°C max.
  - Tip diameter: φ3mm max.
  - Soldering time : 3(+1,-0) seconds.
  - Times : 2times max.

Notes: Do not touch the products directly with the soldering iron.



#### 4. Solder Volume

Solder shall be used not to be exceeded the upper limits as shown below.

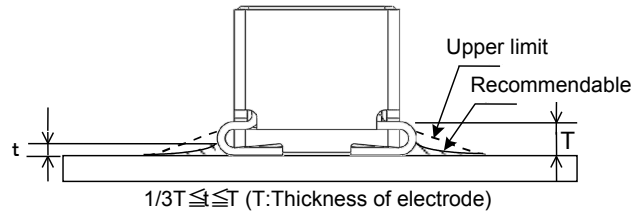

Accordingly increasing the solder volume, the mechanical stress to Chip is also increased. Exceeding solder volume may cause the failure of mechanical or electrical performance. In case if the solder volume is much, we recommend to make the size of the solder paste with less than the land pattern.

#### 15.8 Caution for use

- When you hold products with a tweezer, please hold like a figure of the right side, and sharp material, such as a pair of tweezers, shall not be touched to the Electrode.
- Mechanical shock should not be applied to the products mounted on the board to prevent the damage to electrode.

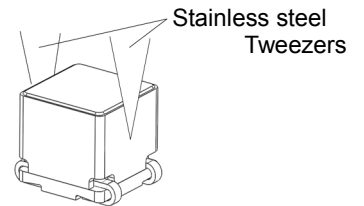

#### Handling of a substrate

After mounting products on a substrate, do not apply any stress to the product caused by bending or twisting to the substrate when cropping the substrate, inserting and removing a connector from the substrate or tightening screw to the substrate.

Excessive mechanical stress may cause cracking in the product.

Bending

Twisting



#### 15.9 Operating Environment

Do not use this product under the following environmental conditions, on deterioration of the Insulation Resistance and/or corrosion of Inner Electrode may result from the use.

- (1) In the corrodible atmosphere (acidic gas, alkaline gas, chlorine, sulfur gas, organic gas and etc.)
- (2) In the atmosphere where liquid such as organic solvent, may splash on the products.
- (3) In the atmosphere where the temperature / humidity changes rapidly and it is easy to dew.
- (4) In the atmosphere where the product is covered with dust or is subjected to salty breeze.

#### 15.10 Storage Conditions

##### (1) Storage period

Use the products within 12 months after delivered.

Solderability should be checked if this period is exceeded.

##### (2) Storage conditions

- Products should be stored in the warehouse on the following conditions.

Temperature: -10°C to 40°C

Humidity: 15% to 85% relative humidity

No rapid change on temperature and humidity

- Don't keep products in corrosive gases such as sulfur, chlorine gas or acid, or it may cause oxidization of electrode, resulting in poor solderability.
- Products should be stored on the palette for the prevention of the influence from humidity, dust and so on.
- Products should be stored in the warehouse without heat shock, vibration, direct sunlight and so on.
- Products should be stored under the airtight packaged condition.

##### (3) Delivery

Care should be taken when transporting or handling product to avoid excessive vibration or mechanical shock.

**16. ▲Note**

- (1)Please make sure that your product has been evaluated in view of your specifications with our product being mounted to your product.
- (2)You are requested not to use our product deviating from the reference specifications.
- (3)The contents of this reference specification are subject to change without advance notice. Please approve our product specifications or transact the approval sheet for product specifications before ordering.

# Mouser Electronics

Authorized Distributor

Click to View Pricing, Inventory, Delivery & Lifecycle Information:

[Murata:](#)

[PLT5BPH1015R6SNL](#) [PLT5BPH2014R4SNL](#) [PLT5BPH5013R1SNL](#) [PLT5BPH3013R7SNL](#) [PLT5BPH2014R4SNB](#)