

GENERAL FEATURES

- $V_{DS}=60V, I_D=6A$
- $R_{DS(ON)} < 35m\Omega @ V_{GS}=10V$
- $R_{DS(ON)} < 45m\Omega @ V_{GS}=4.5V$

Application

- Load/Power Switching
- Interfacing Switching
- Logic Level Shift

Package and Pin Configuration

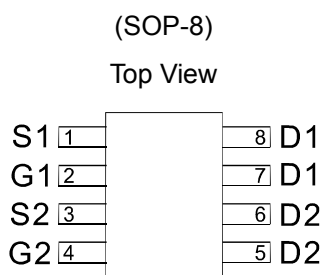

Circuit diagram

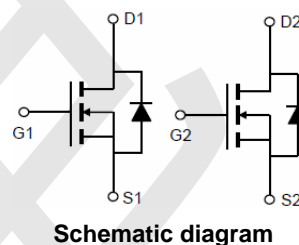

Marking:

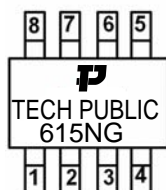

Absolute Maximum Ratings ($T_A=25^\circ C$ unless otherwise noted)

Parameter	Symbol	Limit	Unit
Drain-Source Voltage	V_{DS}	60	V
Gate-Source Voltage	V_{GS}	± 20	V
Drain Current-Continuous	I_D	6	A
Drain Current-Continuous($T_C=100^\circ C$)	$I_D(100^\circ C)$	3.5	A
Pulsed Drain Current	I_{DM}	24	A
Maximum Power Dissipation	P_D	2	W
Operating Junction and Storage Temperature Range	T_J, T_{STG}	-55 To 150	$^\circ C$

Thermal Characteristic

Thermal Resistance, Junction-to-Ambient ^(Note 2)	$R_{\theta JA}$	62.5	$^\circ C/W$
---	-----------------	------	--------------

Electrical Characteristics (T_A=25°C unless otherwise noted)

Parameter	Symbol	Condition	Min	Typ	Max	Unit
Off Characteristics						
Drain-Source Breakdown Voltage	BV _{DSS}	V _{GS} =0V, I _D =250μA	60	-	-	V
Zero Gate Voltage Drain Current	I _{DSS}	V _{DS} =60V, V _{GS} =0V	-	-	1	μA
Gate-Body Leakage Current	I _{GSS}	V _{GS} =±20V, V _{DS} =0V	-	-	±100	nA
On Characteristics (Note 3)						
Gate Threshold Voltage	V _{GS(th)}	V _{DS} =V _{GS} , I _D =250μA	1.2	1.6	2.5	V
Drain-Source On-State Resistance	R _{DS(ON)}	V _{GS} =10V, I _D =5A	-	26	35	mΩ
	R _{DS(ON)}	V _{GS} =4.5V, I _D =5A	-	32	45	mΩ
Forward Transconductance	g _{FS}	V _{DS} =5V, I _D =5A	11	-	-	S
Dynamic Characteristics (Note 4)						
Input Capacitance	C _{iss}	V _{DS} =30V, V _{GS} =0V, F=1.0MHz	-	979	-	PF
Output Capacitance	C _{oss}		-	120	-	PF
Reverse Transfer Capacitance	C _{rss}		-	100	-	PF
Switching Characteristics (Note 4)						
Turn-on Delay Time	t _{d(on)}	V _{DD} =30V, R _L =6.7Ω V _{GS} =10V, R _G =3Ω	-	5.2	-	nS
Turn-on Rise Time	t _r		-	3	-	nS
Turn-Off Delay Time	t _{d(off)}		-	17	-	nS
Turn-Off Fall Time	t _f		-	2.5	-	nS
Total Gate Charge	Q _g	V _{DS} =30V, I _D =5A, V _{GS} =10V	-	22	-	nC
Gate-Source Charge	Q _{gs}		-	3.3	-	nC
Gate-Drain Charge	Q _{gd}		-	5.2	-	nC
Drain-Source Diode Characteristics						
Diode Forward Voltage (Note 3)	V _{SD}	V _{GS} =0V, I _S =5A	-	-	1.2	V
Diode Forward Current (Note 2)	I _S		-	-	6	A
Forward Turn-On Time	t _{on}	Intrinsic turn-on time is negligible (turn-on is dominated by LS+LD)				

Typical Electrical and Thermal Characteristics

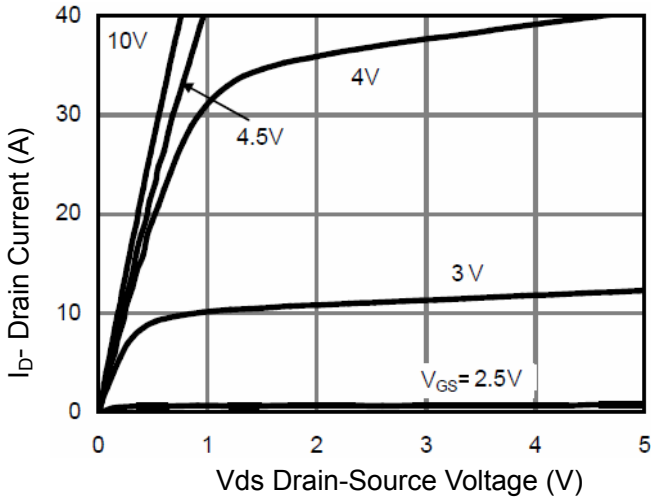

Figure 1 Output Characteristics

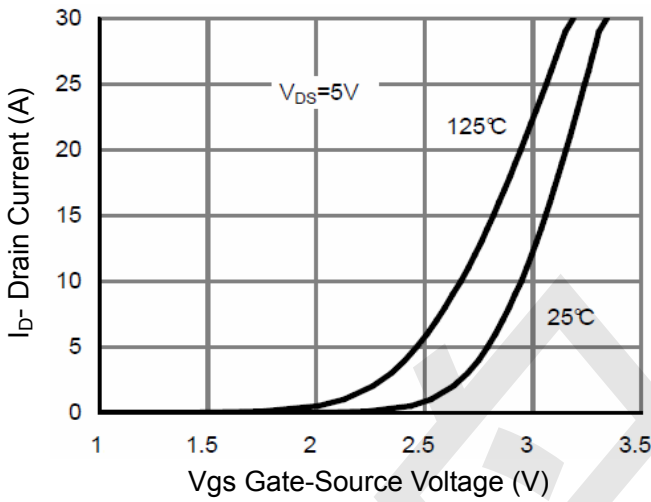

Figure 2 Transfer Characteristics

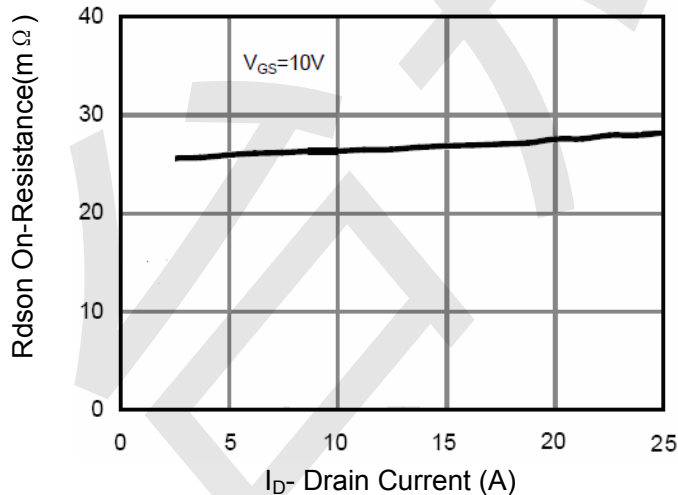

Figure 3 Rdson- Drain Current

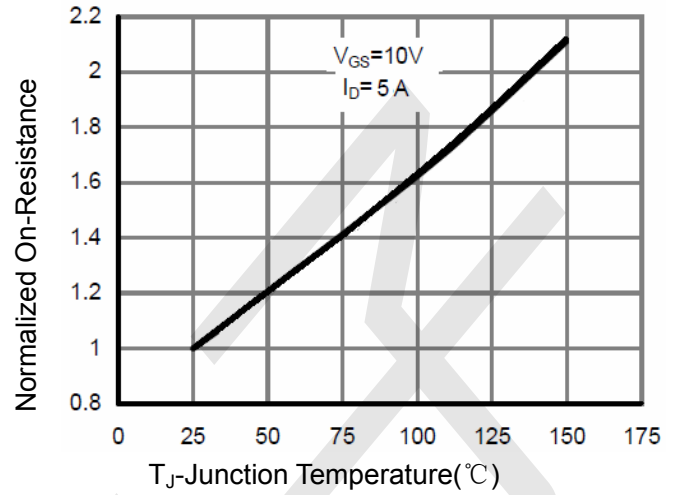

Figure 4 Rdson-Junction Temperature

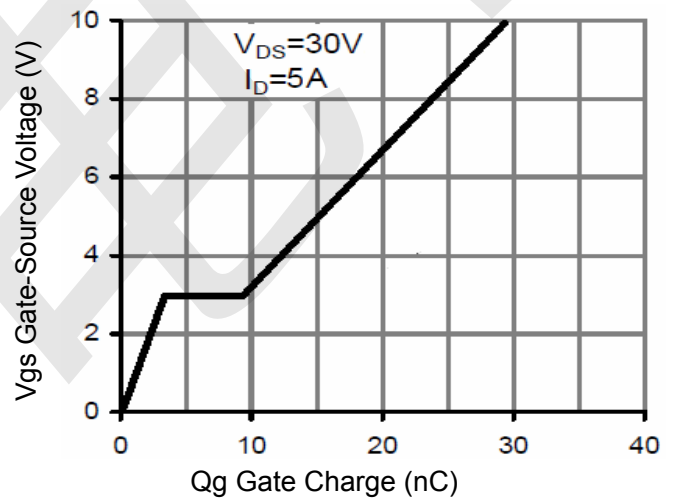

Figure 5 Gate Charge

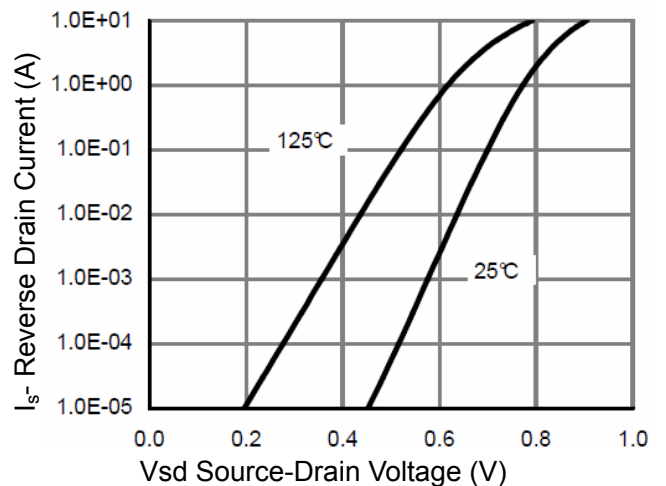

Figure 6 Source- Drain Diode Forward

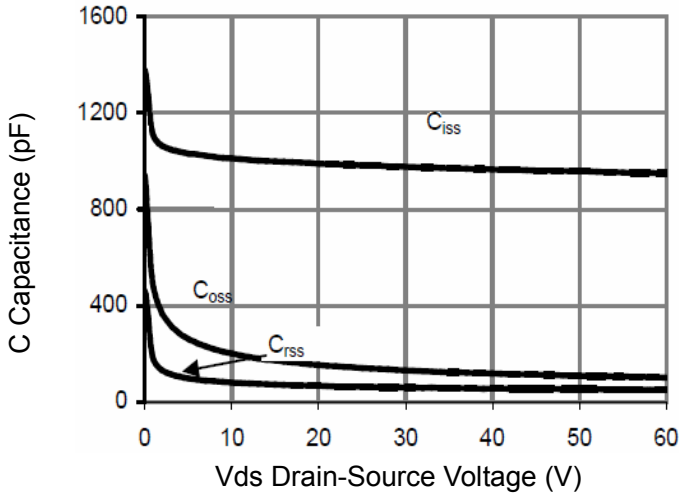

Figure 7 Capacitance vs Vds

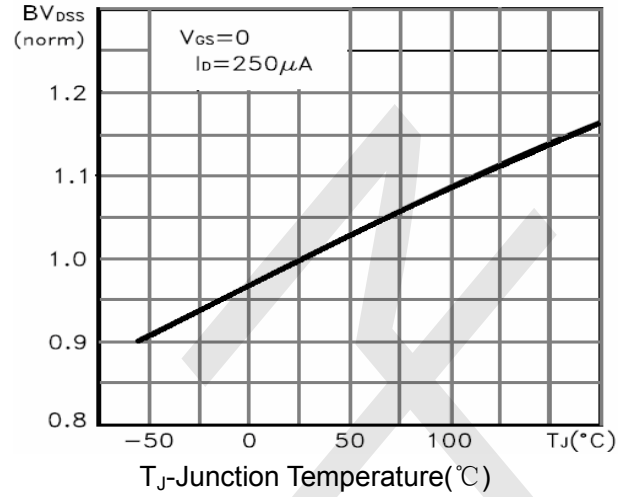

Figure 9 BV_{DSS} vs Junction Temperature

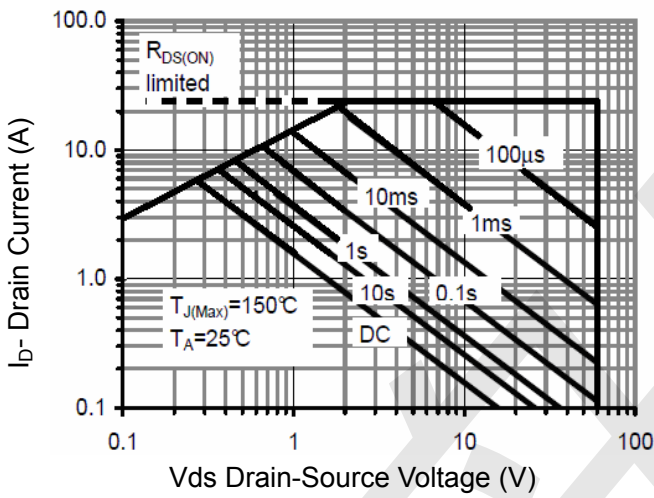

Figure 8 Safe Operation Area

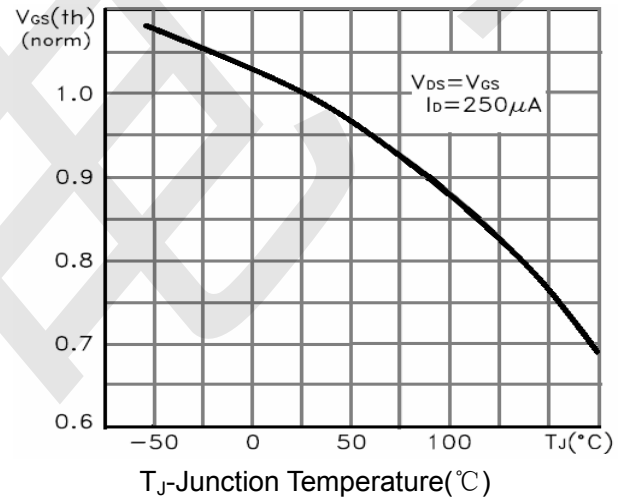

Figure 10 V_{GS(th)} vs Junction Temperature

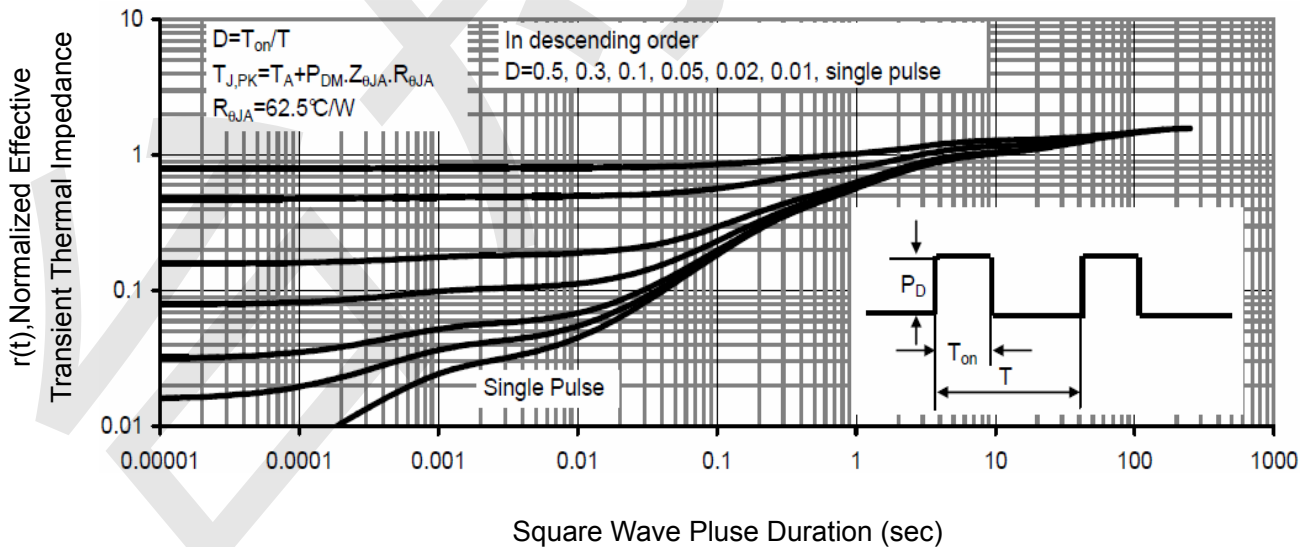
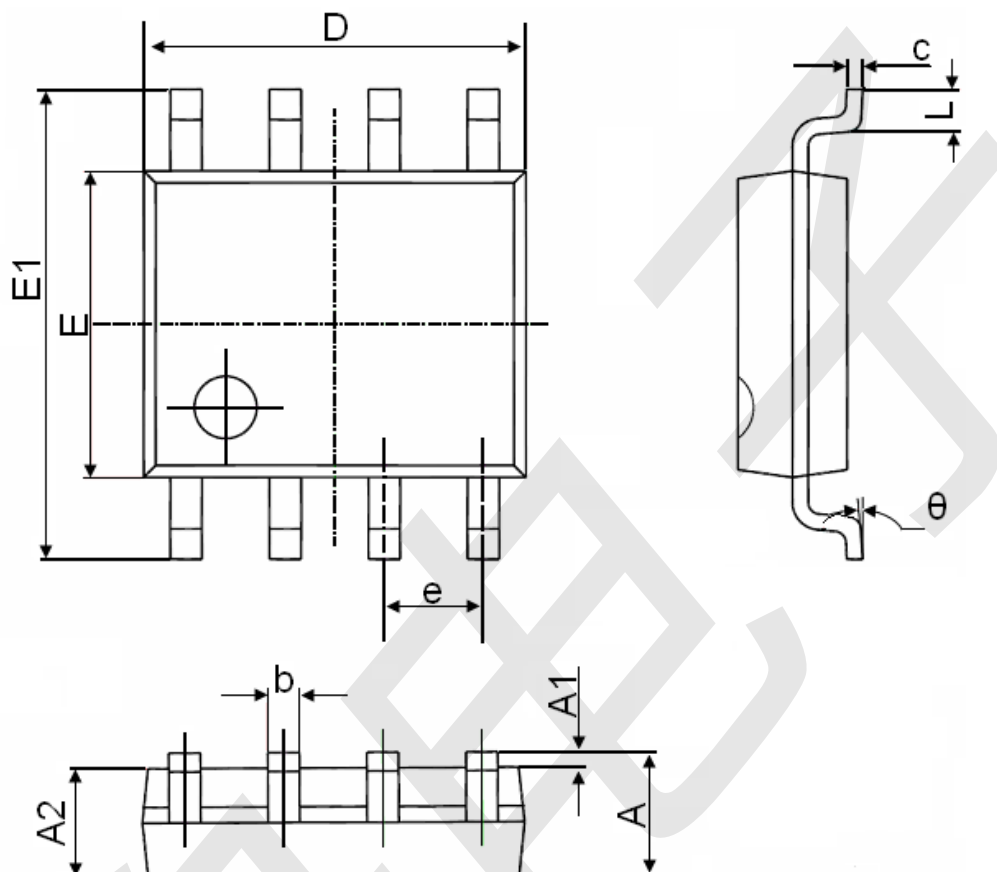

Figure 11 Normalized Maximum Transient Thermal Impedance

SOP-8 Package Information



Symbol	Dimensions In Millimeters		Dimensions In Inches	
	Min.	Max.	Min.	Max.
A	1.350	1.750	0.053	0.069
A1	0.100	0.250	0.004	0.010
A2	1.350	1.550	0.053	0.061
b	0.330	0.510	0.013	0.020
c	0.170	0.250	0.006	0.010
D	4.700	5.100	0.185	0.200
E	3.800	4.000	0.150	0.157
E1	5.800	6.200	0.228	0.244
e	1.270(BSC)		0.050(BSC)	
L	0.400	1.270	0.016	0.050
θ	0°	8°	0°	8°