

High operation force satisfies the needs in automotive applications. Wide stem & good mountability



TACT Switch™

Sharp Feeling

Soft Feeling

Snap-In Type

Surface Mount Type

Radial Type



### Typical Specifications

Items	Specifications
Rating (max.)	50mA 16V DC
Rating (min.)	10μA 1V DC
Initial contact resistance	500mΩ max.
Travel (mm)	0.2

### Product Line

#### Standard type

Product No.	Operating force	Operating direction	Operating life (50mA 16V DC)	Stem color	Minimum order unit (pcs.)	
					Japan	Japan
<b>SKRPABE010</b>	1.57N	Top push	100,000cycles	Natural	4,000	4,000
<b>SKRPACE010</b>	2.55N		50,000cycles			
<b>SKRPADE010</b>	4N		100,000cycles	Black		
<b>SKRPARE010</b>	5N		300,000cycles			

#### Long-life type

Product No.	Operating force	Operating direction	Operating life (50mA 16V DC)	Stem color	Minimum order unit (pcs.)	
					Japan	Japan
<b>SKRPANE010</b>	1.57N	Top push	1,000,000cycles	Natural	4,000	4,000
<b>SKRPASE010</b>	2.55N		500,000cycles	Black		

### Packing Specifications

#### Taping

Number of packages (pcs.)			Tape width (mm)	Export package measurements (mm)
1 reel	1 case / Japan	1 case / export packing		
4,000	40,000	40,000	12	395×395×205

#### Note

For reels of 330mm diameter, please inquire.

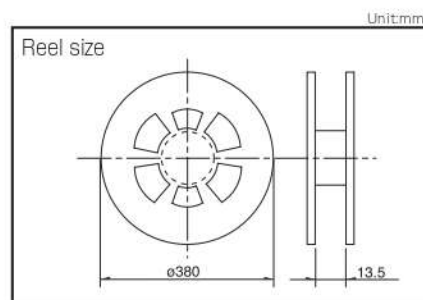

Refer to P.235 for soldering conditions.

■ Dimensions

Unit:mm

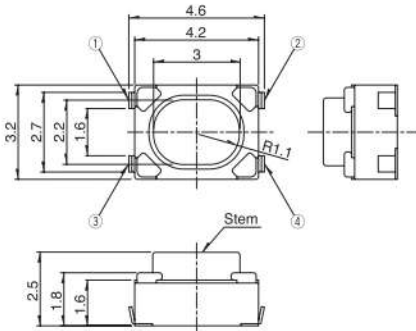
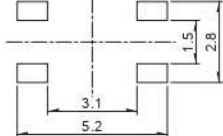



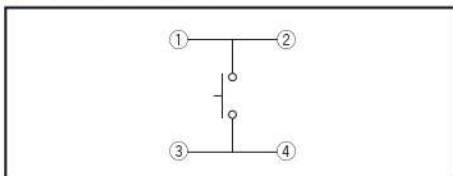











Style	PC board land dimensions (Viewed from switch mounting face)
	

■ Circuit Diagram



# TACT Switch™

## List of Varieties

Type		Sharp Feeling Type							
		Surface Mount							
Series		SKRK	SKTH	SKRP	SKQM	SKQY	SKTQ	SKTR	SKSU
Photo									
Features		Compact size Low-profile	Compact size	High operation force Compact size	Compact size		Middle travel		
Water-proof		—	—	—	—	—	—	—	●
Dustproof		—	●	—	—	—	—	—	●
IP standard		—	—	—	—	—	—	—	67 equivalent
Operating direction	Top push	●	●	●	●	●	●	●	●
	Side push	—	—	—	—	—	—	—	—
Dimensions (mm)	W	3.9	3.5	4.2	6	6.1	5.3	□6.1	5.3
	D	2.9	3.2		3.5	3.7	5.4		5.4
	H	1.5/2	1.8/2.5	2.5	4.3/5	2.5	4.25	4.1	3.85/4.34
Operation force coverage	1N max.	↕	↕	↕	↕	↕	↕	↕	↕
	1N to 2N								
	2N to 3N								
	3N to 4N								
4N to 5N									
Travel (mm)		0.13	0.12	0.2	0.25		0.71	0.72	0.7/0.9
Ground terminal		—	—	—	—	○	—	—	—
Operating temperature range		-40°C to +85°C			-40°C to +90°C				
Automotive use		—	●	●	●	●	●	●	●
Life Cycle									
Electrical performance	Rating (max.) (Resistive load)	50mA 12V DC	25mA 16V DC	50mA 16V DC	50mA 12V DC		50mA 16V DC		
	Rating (min.) (Resistive load)	10μA 1V DC							
	Insulation resistance	100MΩ min. 100V DC 1min.							
	Voltage proof	250V AC 1min.	100V AC 1min.	250V AC 1min.					
Durability	Vibration	10 to 55 to 10Hz/min., the amplitude is 1.5mm for all the frequencies, in the 3 direction of X, Y and Z for 2 hours respectively							
	Lifetime	Shall be in accordance with individual specifications.							
Environmental performance	Cold	-40°C 96h		-40°C 1,000h	-40°C 96h		-40°C 1,000h		
	Dry heat	90°C 96h		90°C 1,000h	90°C 96h		90°C 1,000h		
	Damp heat	60°C, 90 to 95%RH 96h		60°C, 90 to 95%RH 1,000h	60°C, 90 to 95%RH 96h		60°C, 90 to 95%RH 1,000h		
Page		204	206	208	210	211	213	214	215

W : Width. The most outer dimension excluding terminal portion.  
D : Depth. The most outer dimension excluding terminal portion.  
H : Height. The minimum dimension if there are variances.

TACT Switch™ Soldering Conditions ..... 235  
TACT Switch™ Cautions ..... 236

### Notes

- The automotive operating temperature range to be individually discussed upon request.
- Indicates applicability to all products in the series, while ○ indicates applicability to some products in the series.

## Condition for Reflow

Available for Surface Mount Type.

Temperature profile

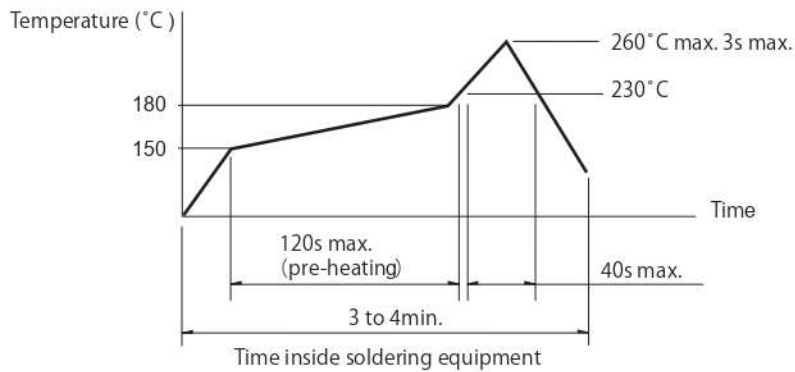

### Notes

1. Please confirm the specifications of our product for the detailed condition.
2. Soldering conditions differ depending on reflow soldering machines. Prior verification of soldering condition is highly recommended.

## Conditions for Auto-dip

Available for Snap-in Type and Radial Type.

Items	Condition
Flux built-up	Mounting surface should not be exposed to flux
Preheating temperature	Ambient temperature of the soldered surface of PC board, 100°C max.
Preheating time	60s max.
Soldering temperature	260°C max.
Duration of immersion	5s max.
Number of soldering	2times max.

### SKHH Series

Items	Condition
Flux built-up	Mounting surface should not be exposed to flux
Preheating temperature	Ambient temperature of the soldered surface of PC board, 100°C max.
Preheating time	60s max.
Soldering temperature	260°C max.
Duration of immersion	5s max.
Number of soldering	2times max.

### SKHL Top Push Type, SKQJ Series

Items	Condition
Flux built-up	Mounting surface should not be exposed to flux
Preheating temperature	Ambient temperature of the soldered surface of PC board, 100°C max.
Preheating time	45s max.
Soldering temperature	255°C max.
Duration of immersion	5s max.
Number of soldering	2times max.

### Notes

1. Prevent flux penetration from the top side of the TACT Switch™.
2. Switch terminals and a PC board should not be coated with flux prior to soldering.
3. The second soldering should be done after the switch is stable with normal temperature.
4. Use the flux with a specific gravity of min 0.81.  
(EC-19S-8 by TAMURA CORPORATION, or equivalents.)

## Manual Soldering

Items	Condition
Soldering temperature	350°C max.
Duration of soldering	3s max.
Capacity of soldering iron	60W max.

### SKHH, SKHW Series

Items	Condition
Soldering temperature	360°C max.
Duration of soldering	3s max.
Capacity of soldering iron	60W max.

### SKTD, SKTG, SKQJ, SKSN Series

Items	Condition
Soldering temperature	350°C max.
Duration of soldering	3s max.
Capacity of soldering iron	20W max.