

### Features

- $V_{DS} = 60V, I_D = 50A$   
 $R_{DS(ON)} < 20m\Omega @ V_{GS} = 10V$

### Application

- Power Management in Note book
- DC/DC Converter
- Load Switch
- LCD Display inverter

### Package and Pin Configuration

(TO-252-3L)

Top View

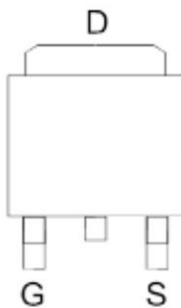

### Circuit diagram

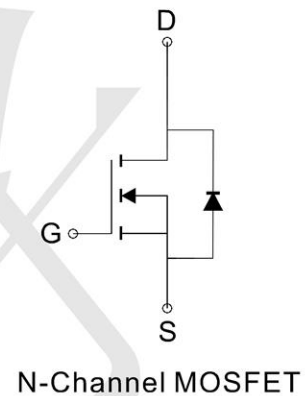

Marking:



### Absolute Maximum Ratings ( $T_C = 25^\circ C$ unless otherwise specified)

Parameter	Symbol	Limit	Unit
Drain-Source Voltage	$V_{DS}$	60	V
Gate-Source Voltage	$V_{GS}$	$\pm 20$	V
Drain Current-Continuous	$I_D$	50	A
Drain Current-Continuous( $T_C = 100^\circ C$ )	$I_D(100^\circ C)$	35.4	A
Pulsed Drain Current	$I_{DM}$	200	A
Maximum Power Dissipation	$P_D$	85	W
Derating factor		0.57	W/ $^\circ C$
Single pulse avalanche energy <sup>(Note 5)</sup>	$E_{AS}$	300	mJ
Operating Junction and Storage Temperature Range	$T_J, T_{STG}$	-55 To 175	$^\circ C$

### Thermal Characteristic

Thermal Resistance, Junction-to-Case <sup>(Note 2)</sup>	$R_{\theta JC}$	1.8	$^\circ C/W$
--	-----------------	-----	--------------

**Electrical Characteristics** ( $T_J=25^\circ\text{C}$  unless otherwise specified)

Parameter	Symbol	Condition	Min	Typ	Max	Unit
<b>Off Characteristics</b>						
Drain-Source Breakdown Voltage	$BV_{DSS}$	$V_{GS}=0V, I_D=250\mu A$	60	-	-	V
Zero Gate Voltage Drain Current	$I_{DSS}$	$V_{DS}=60V, V_{GS}=0V$	-	-	1	$\mu A$
Gate-Body Leakage Current	$I_{GSS}$	$V_{GS}=\pm 20V, V_{DS}=0V$	-	-	$\pm 100$	nA
<b>On Characteristics</b> (Note 3)						
Gate Threshold Voltage	$V_{GS(th)}$	$V_{DS}=V_{GS}, I_D=250\mu A$	1.4	1.9	2.5	V
Drain-Source On-State Resistance	$R_{DS(ON)}$	$V_{GS}=10V, I_D=20A$	-	14	20	m $\Omega$
Forward Transconductance	$g_{FS}$	$V_{DS}=5V, I_D=20A$	18	-	-	S
<b>Dynamic Characteristics</b> (Note 4)						
Input Capacitance	$C_{iss}$	$V_{DS}=30V, V_{GS}=0V,$ $F=1.0\text{MHz}$	-	2050	-	PF
Output Capacitance	$C_{oss}$		-	158	-	PF
Reverse Transfer Capacitance	$C_{rss}$		-	120	-	PF
<b>Switching Characteristics</b> (Note 4)						
Turn-on Delay Time	$t_{d(on)}$	$V_{DD}=30V, R_L=6.7\Omega$ $V_{GS}=10V, R_G=3\Omega$	-	7.4	-	nS
Turn-on Rise Time	$t_r$		-	5.1	-	nS
Turn-Off Delay Time	$t_{d(off)}$		-	28.2	-	nS
Turn-Off Fall Time	$t_f$		-	5.5	-	nS
Total Gate Charge	$Q_g$	$V_{DS}=30V, I_D=20A,$ $V_{GS}=10V$	-	50	-	nC
Gate-Source Charge	$Q_{gs}$		-	6	-	nC
Gate-Drain Charge	$Q_{gd}$		-	15	-	nC
<b>Drain-Source Diode Characteristics</b>						
Diode Forward Voltage (Note 3)	$V_{SD}$	$V_{GS}=0V, I_S=20A$	-	-	1.2	V
Diode Forward Current (Note 2)	$I_S$		-	-	50	A
Reverse Recovery Time	$t_{rr}$	$T_J = 25^\circ\text{C}, I_F = 20A$ $di/dt = 100A/\mu s$ (Note 3)	-	28	-	nS
Reverse Recovery Charge	$Q_{rr}$		-	40	-	nC
Forward Turn-On Time	$t_{on}$	Intrinsic turn-on time is negligible (turn-on is dominated by LS+LD)				

**Typical Electrical and Thermal Characteristics (Curves)**

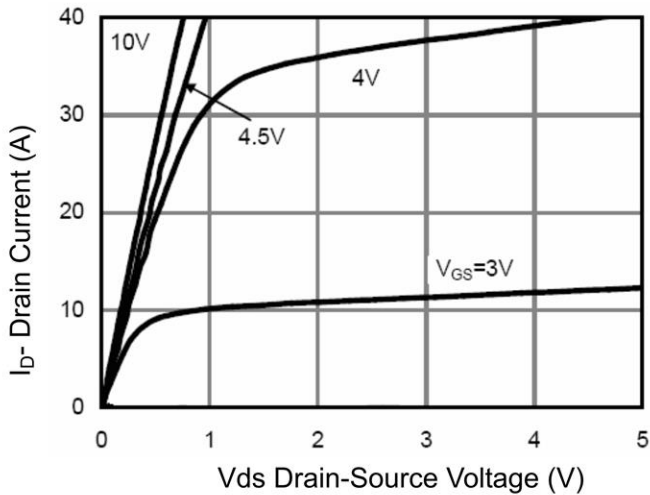

**Figure 1 Output Characteristics**

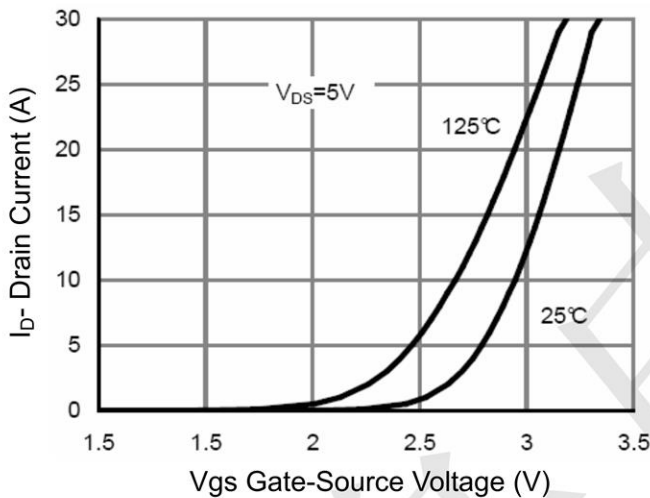

**Figure 2 Transfer Characteristics**

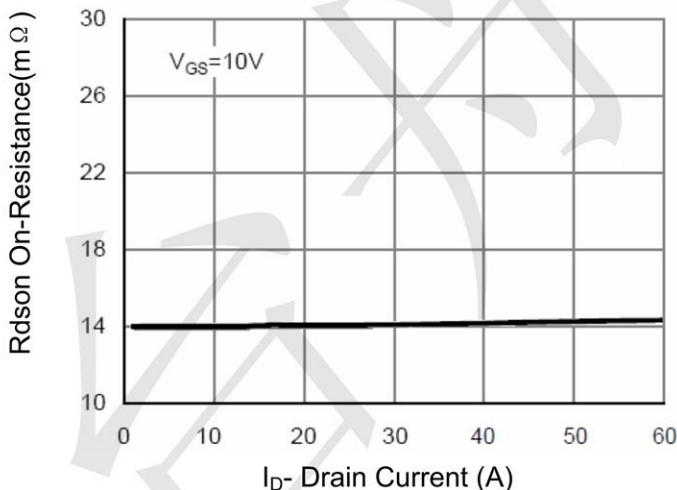

**Figure 3 Rdson- Drain Current**

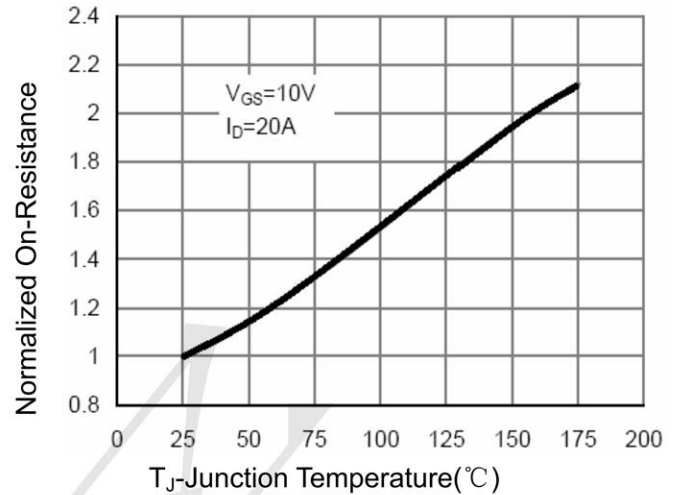

**Figure 4 Rdson-Junction Temperature**

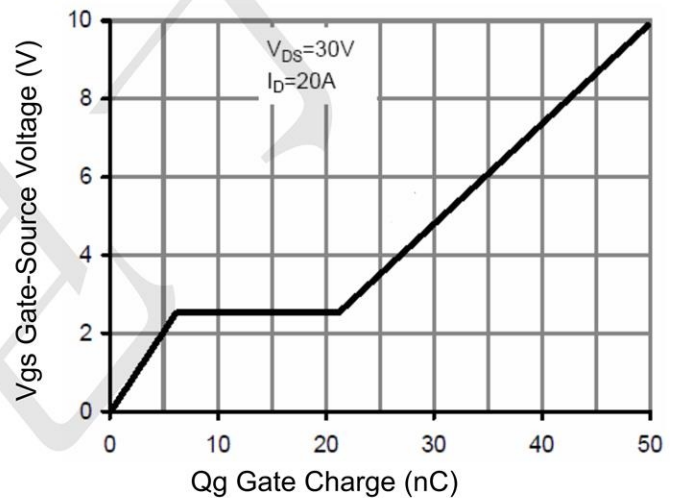

**Figure 5 Gate Charge**

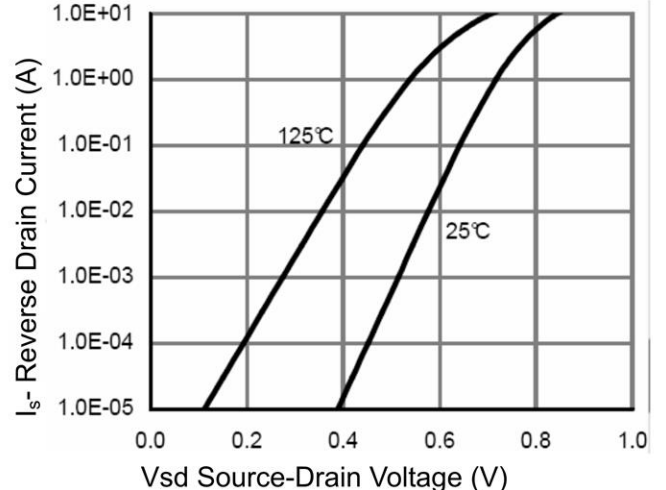

**Figure 6 Source- Drain Diode Forward**

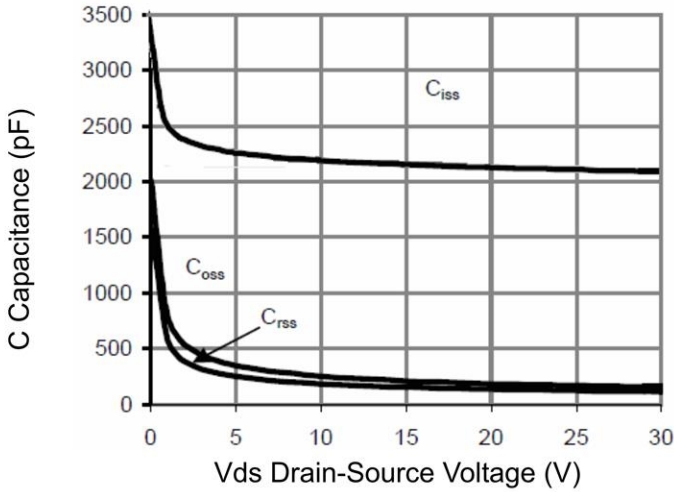

Figure 7 Capacitance vs Vds

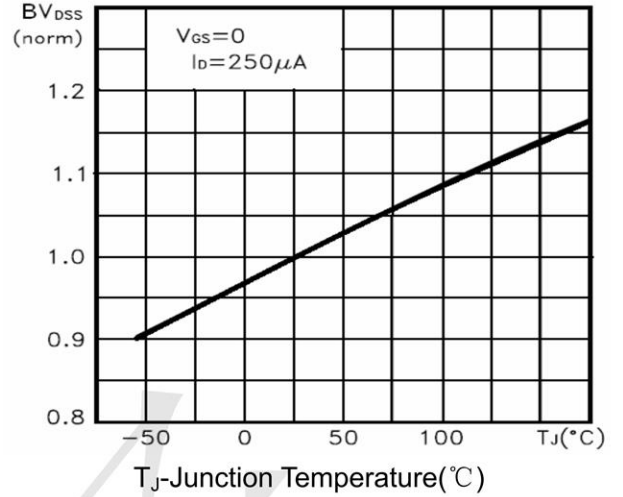

Figure 9  $BV_{DSS}$  vs Junction Temperature

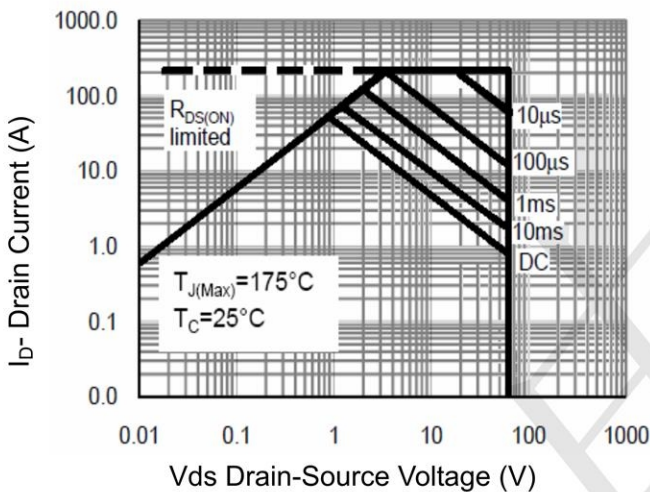

Figure 8 Safe Operation Area

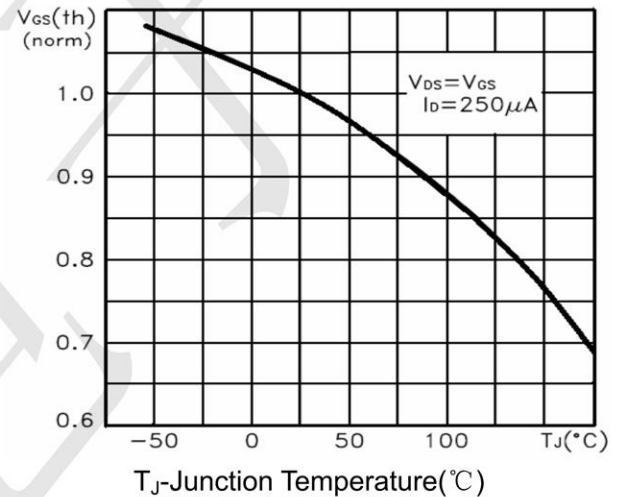

Figure 10  $V_{GS(th)}$  vs Junction Temperature

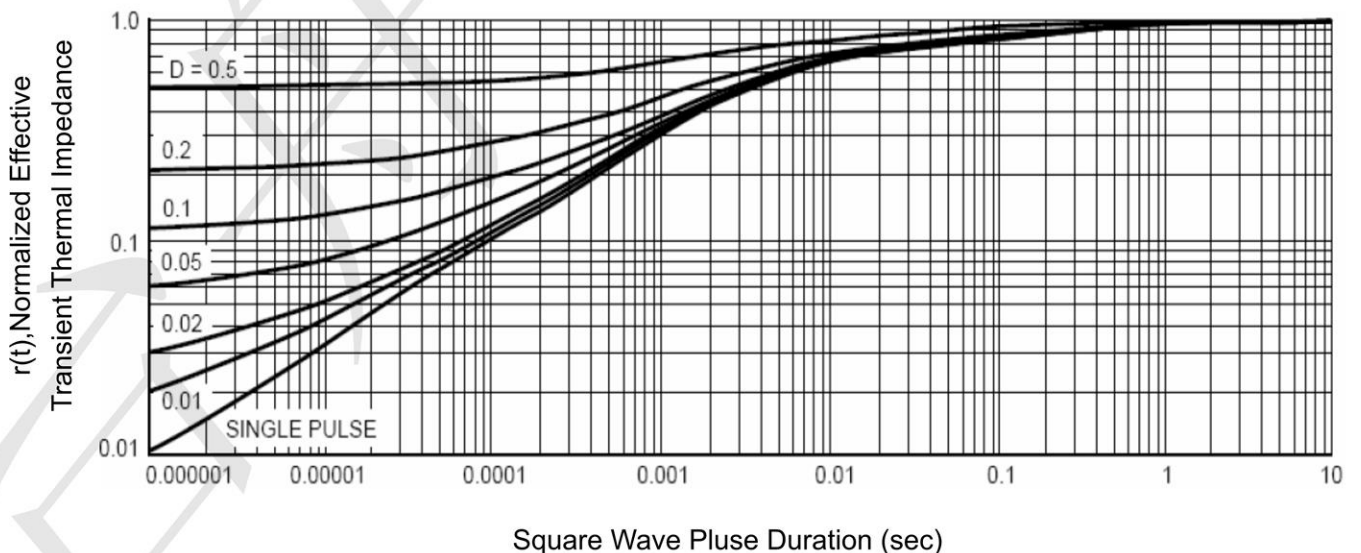
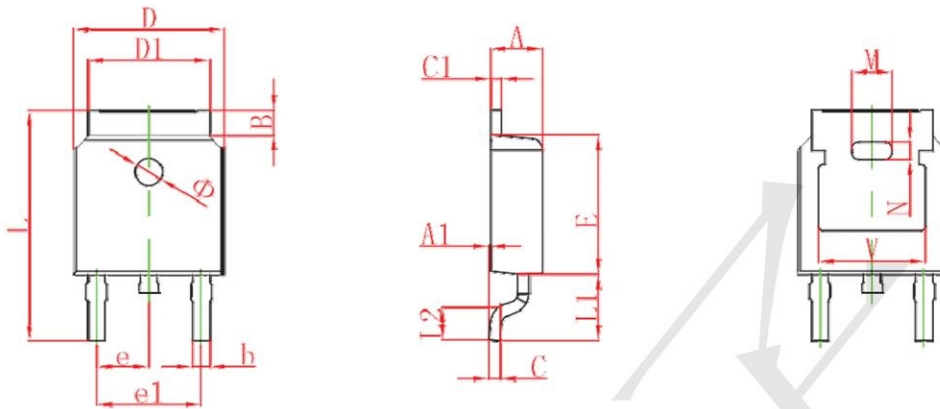

Figure 11 Normalized Maximum Transient Thermal Impedance



**TO252 Package Information**



Symbol	Dimensions In Millimeters		Dimensions In Inches	
	Min.	Max.	Min.	Max.
A	2.200	2.380	0.087	0.094
A1	0.000	0.100	0.000	0.004
B	0.800	1.400	0.031	0.055
b	0.710	0.810	0.028	0.032
c	0.460	0.560	0.018	0.022
c1	0.460	0.560	0.018	0.022
D	6.500	6.700	0.256	0.264
D1	5.130	5.460	0.202	0.215
E	6.000	6.200	0.236	0.244
e	2.286 TYP.		0.090 TYP.	
e1	4.327	4.727	0.170	0.186
M	1.778REF.		0.070REF.	
N	0.762REF.		0.018REF.	
L	9.800	10.400	0.386	0.409
L1	2.9REF.		0.114REF.	
L2	1.400	1.700	0.055	0.067
V	4.830 REF.		0.190 REF.	
⌀	1.100	1.300	0.043	0.051