

GENERAL FEATURES

- $V_{DS} = -30V, I_D = -12A$
- $R_{DS(ON)}(Typ.) 9.5m\Omega @ V_{GS} = -10V$
- $R_{DS(ON)}(Typ.) 14m\Omega @ V_{GS} = -4.5V$

Application

- PWM applications
- Load switch
- Power management

Package and Pin Configuration

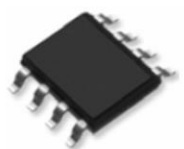

SOP-8 top view

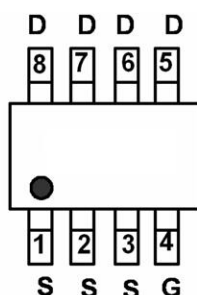

Circuit diagram

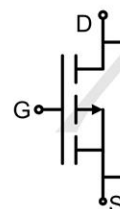

Marking:

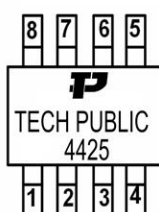

Absolute Maximum Ratings ($T_A = 25^\circ C$ unless otherwise noted)

Parameter	Symbol	Limit	Unit
Drain-Source Voltage	V_{DS}	-30	V
Gate-Source Voltage	V_{GS}	± 20	V
Drain Current-Continuous	I_D	-12	A
Drain Current-Pulsed (Note 1)	I_{DM}	-48	A
Maximum Power Dissipation	P_D	3	W
Operating Junction and Storage Temperature Range	T_J, T_{STG}	-55 To 150	$^\circ C$

Thermal CharacteristicE

Thermal Resistance, Junction-to-Ambient (Note 2)	$R_{\theta JA}$	41.67	$^\circ C/W$
--	-----------------	-------	--------------

Electrical Characteristics (T_A=25°C unless otherwise noted)

Parameter	Symbol	Condition	Min	Typ	Max	Unit
Drain-Source Breakdown Voltage	BV _{DSS}	V _{GS} =0V, I _D =-250μA	-30		-	V
Zero Gate Voltage Drain Current	I _{DSS}	V _{DS} =-30V, V _{GS} =0V	-	-	-1	μA
Gate-Body Leakage Current	I _{GSS}	V _{GS} =±20V, V _{DS} =0V	-	-	±100	nA
On Characteristics (Note 3)						
Gate Threshold Voltage	V _{GS(th)}	V _{DS} =V _{GS} , I _D =-250μA	-1	-1.5	-3	V
Drain-Source On-State Resistance	R _{DS(ON)}	V _{GS} =-10V, I _D =-10A	-	9.5	13	mΩ
		V _{GS} =-4.5V, I _D =-7A	-	14	19	mΩ
Forward Transconductance	g _{FS}	V _{DS} =-10V, I _D =-10A	20	-	-	S
Dynamic Characteristics (Note4)						
Input Capacitance	C _{iss}	V _{DS} =-15V, V _{GS} =0V, F=1.0MHz	-	1200	-	PF
Output Capacitance	C _{oss}		-	200	-	PF
Reverse Transfer Capacitance	C _{rss}		-	150	-	PF
Switching Characteristics (Note 4)						
Turn-on Delay Time	t _{d(on)}	V _{DD} =-15V, I _D =-10A, V _{GS} =-10V, R _{GEN} =1Ω	-	11	-	nS
Turn-on Rise Time	t _r		-	6	-	nS
Turn-Off Delay Time	t _{d(off)}		-	28	-	nS
Turn-Off Fall Time	t _f		-	10	-	nS
Total Gate Charge	Q _g	V _{DS} =-15V, I _D =-10A, V _{GS} =-10V	-	25	-	nC
Gate-Source Charge	Q _{gs}		-	3.9	-	nC
Gate-Drain Charge	Q _{gd}		-	4.8	-	nC
Drain-Source Diode Characteristics						
Diode Forward Voltage (Note 3)	V _{SD}	V _{GS} =0V, I _S =-2A	-	-	-1.2	V

Typical Electrical and Thermal Characteristics

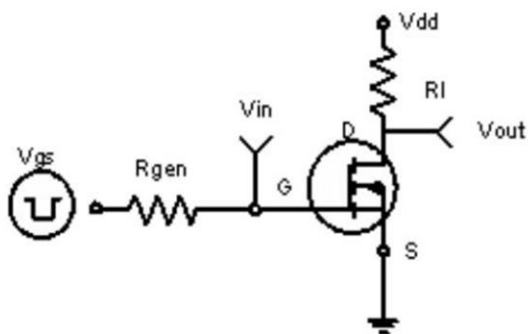

Figure 1: Switching Test Circuit

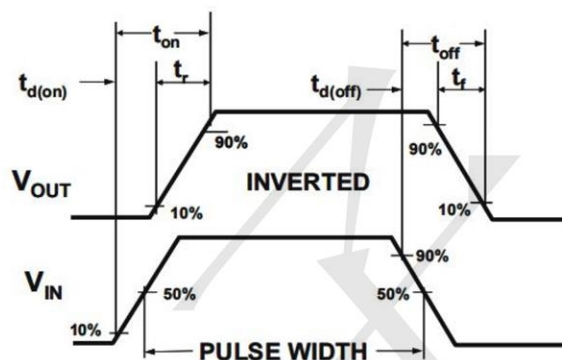
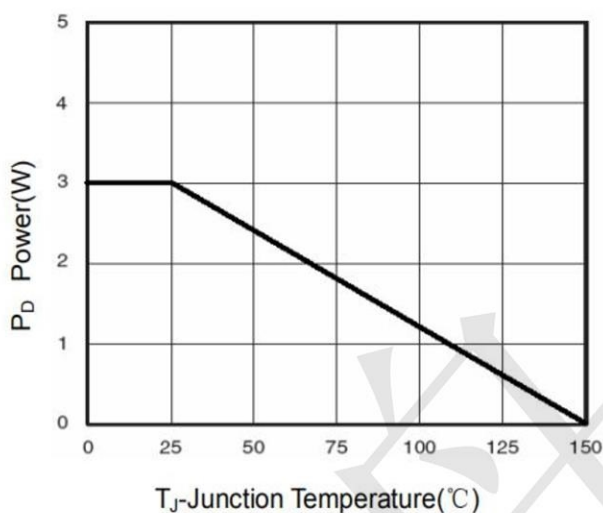
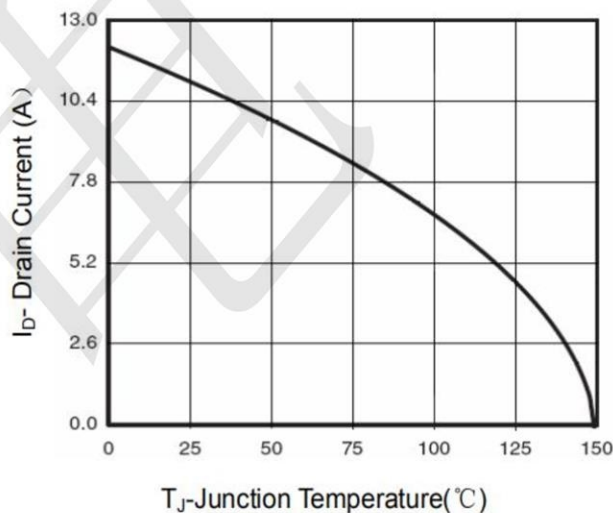

Figure 2: Switching Waveforms



T_J-Junction Temperature (°C)
Figure 3 Power Dissipation



T_J-Junction Temperature (°C)
Figure 4 Drain Current

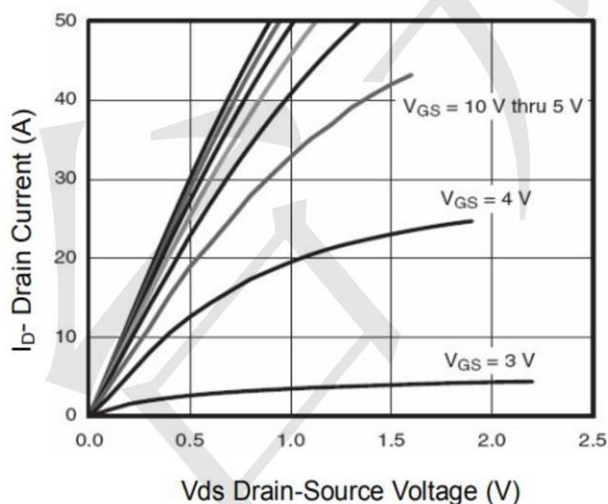

V_{ds} Drain-Source Voltage (V)
Figure 5 Output Characteristics

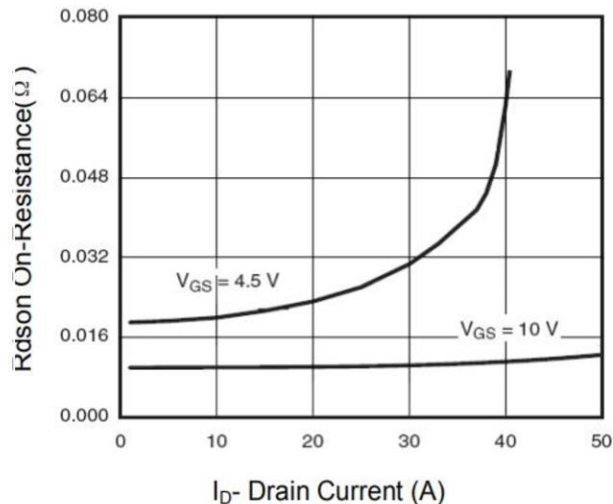

I_D- Drain Current (A)
Figure 6 Drain-Source On-Resistance

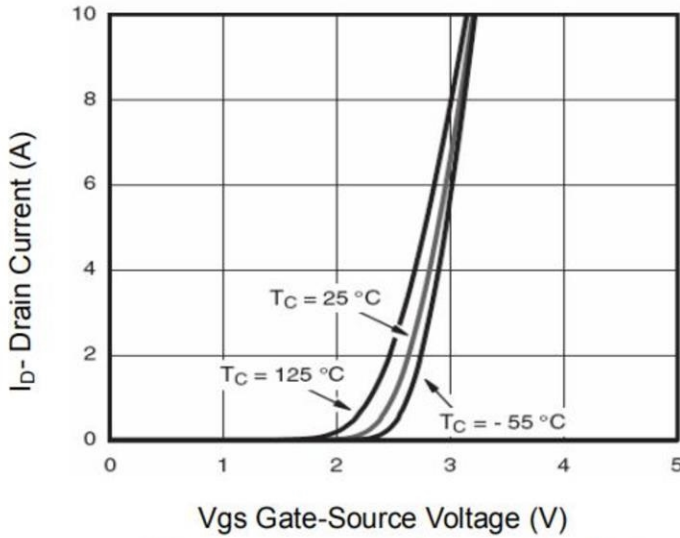

Figure 7 Transfer Characteristics

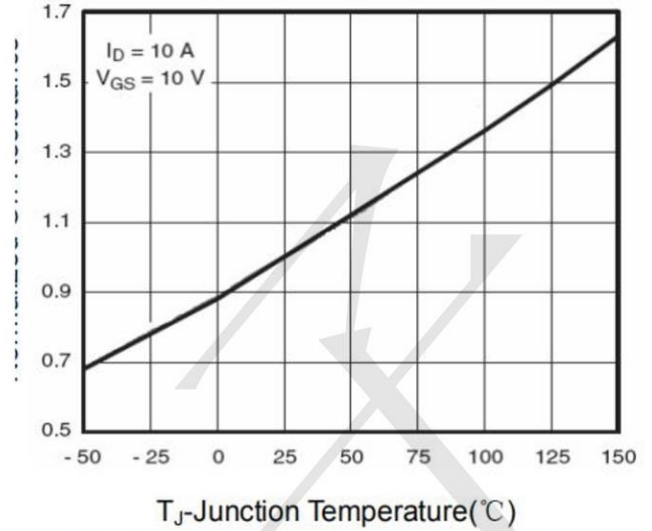

Figure 8 Drain-Source On-Resistance

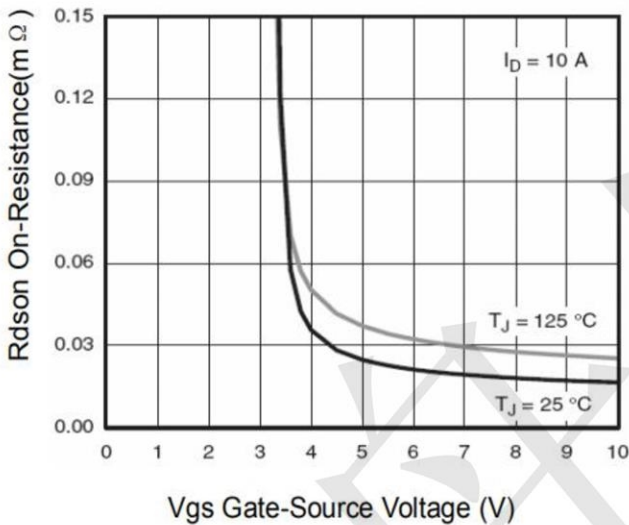

Figure 9 Rdson vs Vgs

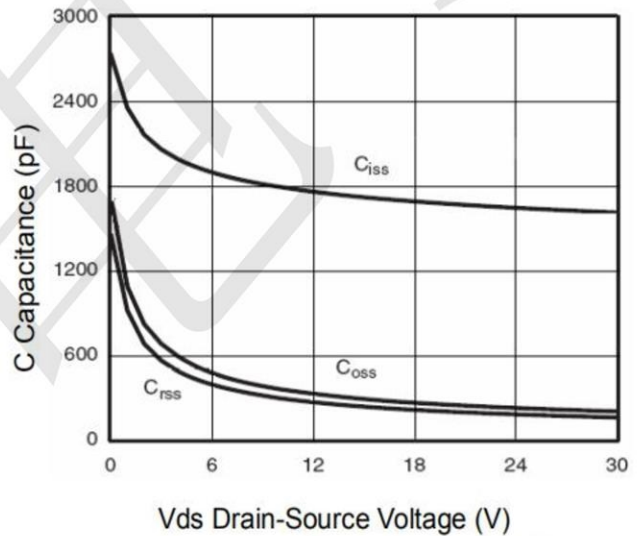

Figure 10 Capacitance vs Vds

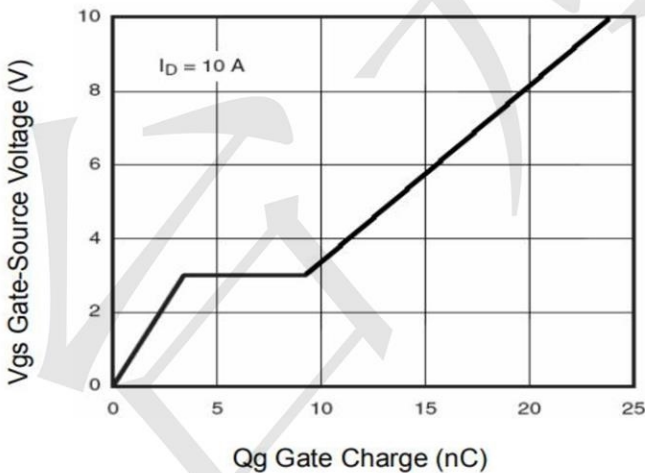

Figure 11 Gate Charge

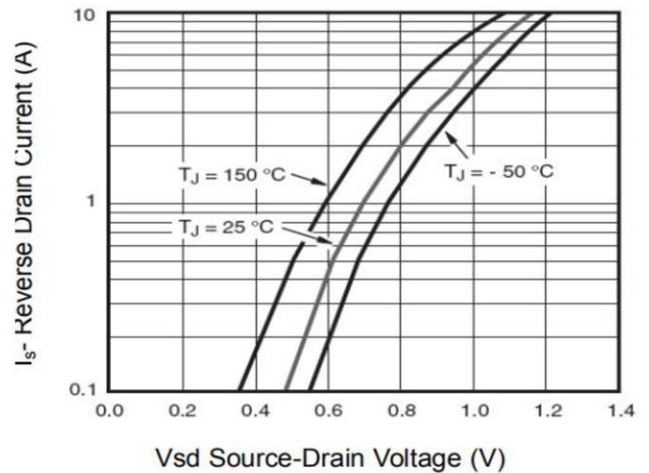

Figure 12 Source-Drain Diode Forward

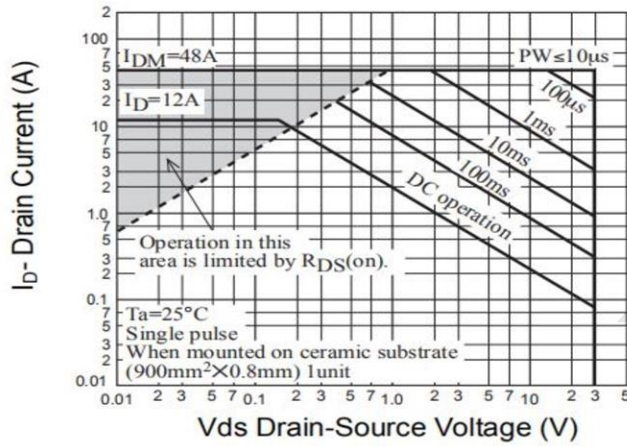

Figure 13 Safe Operation Area

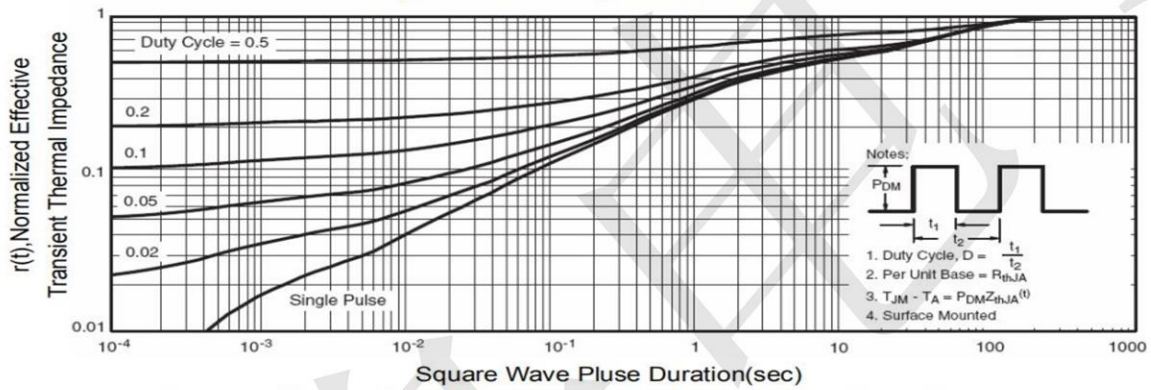
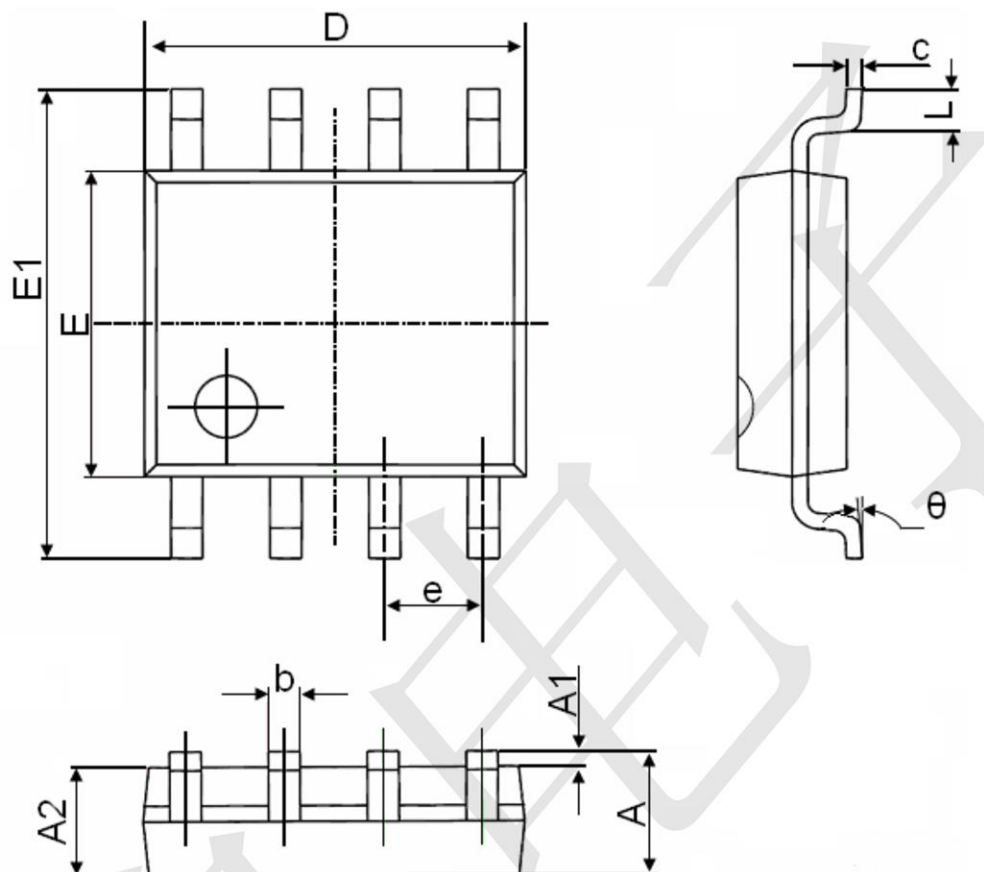

Figure 14 Normalized Maximum Transient Thermal Impedance

SOP-8 Package Information



Symbol	Dimensions In Millimeters		Dimensions In Inches	
	Min.	Max.	Min.	Max.
A	1.350	1.750	0.053	0.069
A1	0.100	0.250	0.004	0.010
A2	1.350	1.550	0.053	0.061
b	0.330	0.510	0.013	0.020
c	0.170	0.250	0.006	0.010
D	4.700	5.100	0.185	0.200
E	3.800	4.000	0.150	0.157
E1	5.800	6.200	0.228	0.244
e	1.270(BSC)		0.050(BSC)	
L	0.400	1.270	0.016	0.050
θ	0°	8°	0°	8°