

**SuperMOS – SOT-23 60V  $V_{DSS}$  1.5 $\Omega$   $R_{DS(on)}$  0.41A  $I_D$ , N-channel MOSFET**

**1. Description**

The NX138AKR-ES is N-Channel enhancement MOS Field Effect Transistor. Uses advanced trench technology and design to provide excellent  $R_{DS(ON)}$  with low gate charge. Device is suitable for use in DC-DC conversion, power switch and charging circuit. Standard Product NX138AKR-ES is Pb-free.

**2. Features**

- 60V,  $R_{DS(ON)}=1.5\Omega(Typ)$ ,  $V_{GS}=10V$   
 $R_{DS(ON)}=1.6\Omega(Typ)$ ,  $V_{GS}=4.5V$
- Use trench MOSFET technology
- High density cell design for low  $R_{DS(on)}$
- Material: Halogen free
- Reliable and rugged
- Avalanche Rated
- Low leakage current

**3. Applications**

- PWM applications
- Load switch
- Power management in portable/desktop PCs
- DC/DC conversion

**4. Ordering Information**

Part Number	Package	Material	Packing	Quantity per reel	Flammability Rating	Reel Size
NX138AKR-ES	SOT-23	Halogen free	Tape & Reel	3,000 PCS	UL 94V-0	7 inches

Table-1 Ordering information

**5. Pin Configuration and Functions**

Pin	Function	Outline	Circuit Diagram
1	Gate		
2	Source		
3	Drain		

Table-2 Pin configuration

## 6. Specification

### Absolute Maximum Rating & Thermal Characteristics

Ratings at 25 °C ambient temperature unless otherwise specified.

Parameter	Symbol	Limit	Unit
Drain-Source Voltage	$BV_{DSS}$	60	V
Gate-Source Voltage	$V_{GS}$	$\pm 20$	V
Continuous Drain Current	$I_D$	0.41	A
Maximum Power Dissipation	$P_D$	417	mW
Pulsed Drain Current <sup>a</sup>	$I_{DM}$	1.64	A
Operating Junction Temperature	$T_J$	150	°C
Lead Temperature	$T_L$	260	°C
Storage Temperature Range	$T_{stg}$	-55 to 150	°C

#### Thermal resistance ratings

Single Operation			
Parameter	Symbol	Typical	Unit
Junction-to-Ambient Thermal Resistance	$R_{\theta JA}$	300	°C/W

Note:

a: Repetitive rating, pulse width limited by junction temperature,  $t_p=10\mu s$ , Duty Cycle=1%

## Electrical Characteristics

At TA = 25°C unless otherwise specified

Parameter	Symbol	Test Conditions	Min.	Typ.	Max.	Unit
<b>OFF CHARACTERISTICS</b>						
Drain-to-Source Breakdown Voltage	$BV_{DSS}$	$V_{GS}=0V, I_D=10mA$	60			V
Zero Gate Voltage Drain Current	$I_{DSS}$	$V_{DS}=60V, V_{GS}=0V, T_J=25^\circ C$			1.0	uA
		$V_{DS}=40V, V_{GS}=0V, T_J=125^\circ C$			100	
Gate-to-source Leakage Current	$I_{GSS}$	$V_{DS}=0V, V_{GS}=\pm 20V$			$\pm 10$	uA
<b>ON CHARACTERISTICS</b>						
Gate Threshold Voltage	$V_{GS(TH)}$	$V_{GS}=V_{DS}, I_D=250uA$	0.8	1.0	1.5	V
Drain-to-source On-resistance	$R_{DS(on)}$	$V_{GS}=10V, I_D=0.5A$		1.5	1.9	Ω
		$V_{GS}=4.5V, I_D=0.2A$		1.6	2.5	
		$V_{GS}=2.5V, I_D=0.1A$		2.73	4.5	
<b>CHARGES, CAPACITANCES AND GATE RESISTANCE</b>						
Input Capacitance	$C_{ISS}$	$V_{GS}=0V, f=1MHz, V_{DS}=25V$		25	50	pF
Output Capacitance	$C_{OSS}$			9.7	22	
Reverse Transfer Capacitance	$C_{RSS}$			2.2	5	
Total Gate Charge	$Q_{G(TOT)}$	$V_{GS}=4.5V, V_{DS}=25V, I_D=0.25A$		0.65	1	nC
Gate-to-Source Charge	$Q_{GS}$			0.2		
Gate-to-Drain Charge	$Q_{GD}$			0.23		
<b>SWITCHING CHARACTERISTICS</b>						
Turn-On Delay Time	$t_{d(ON)}$	$V_{GS}=10V, V_{DS}=25V, I_D=0.5A,$ $R_G=6\Omega$		2.3	5	ns
Rise Time	$t_r$			19.2	40	
Turn-Off Delay Time	$t_{d(OFF)}$			6.3	12	
Fall Time	$t_f$			23	50	
<b>BODY DIODE CHARACTERISTICS</b>						
Forward Voltage	$V_{SD}$	$V_{GS}=0V, I_S=0.5A$		0.86	1.5	V

**7. Typical Characteristic**



**Fig.1 On-Region Characteristics**



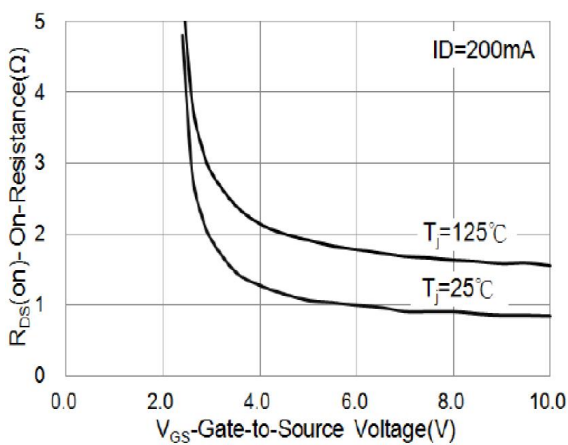
**Fig.2 Transfer Characteristics**



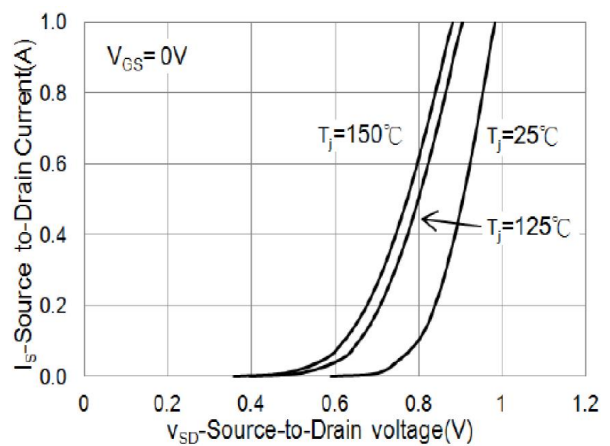
**Fig.3 On-Resistance vs. Drain Current**



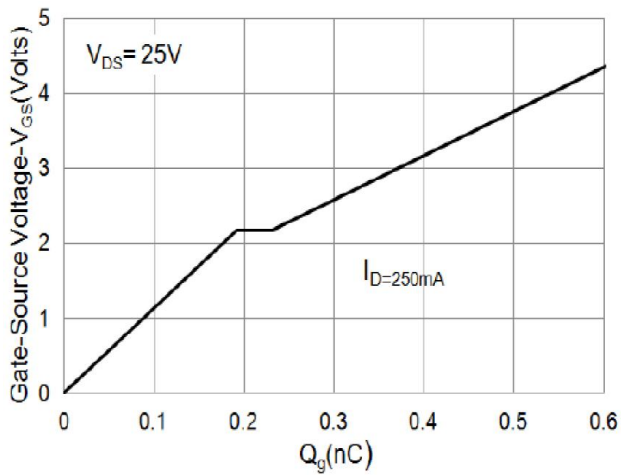
**Fig.4 On-Resistance vs. Junction temperature**



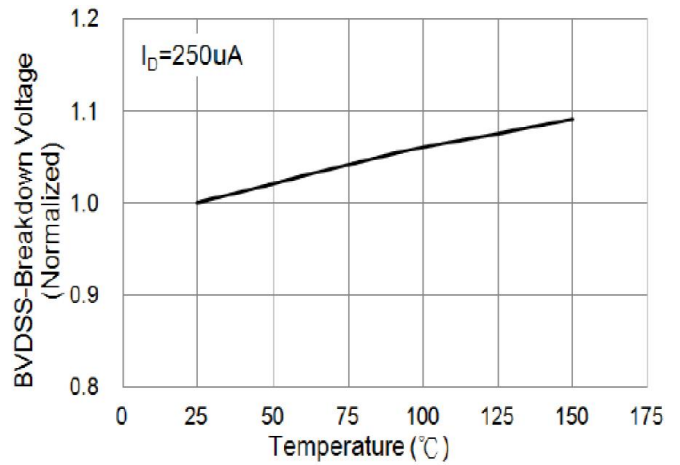
**Fig.5 On-Resistance Variation with VGS**



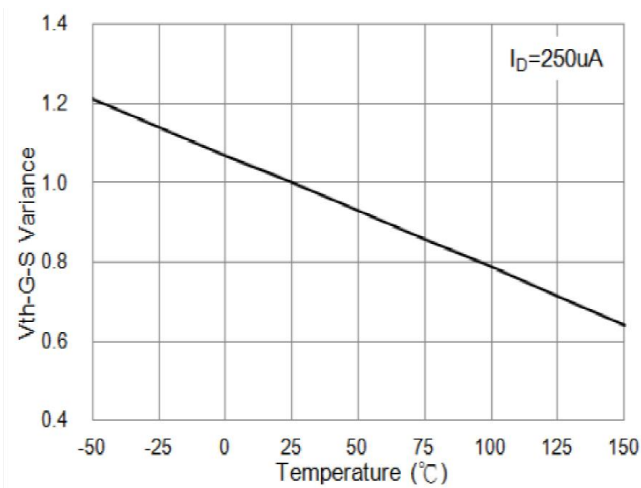
**Fig.6 Body Diode Characteristics**



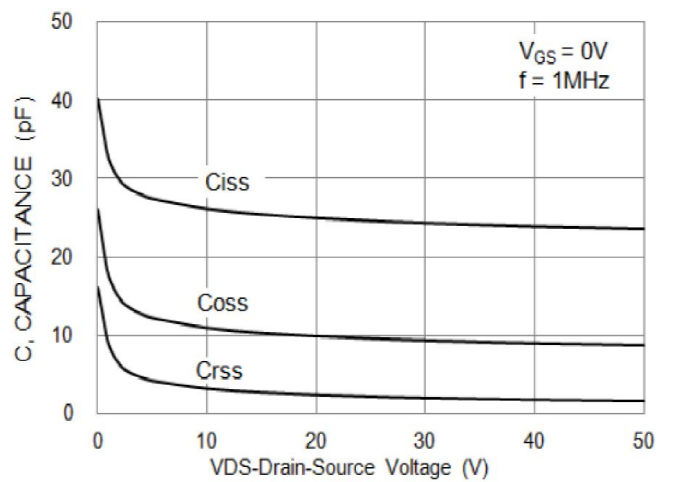
**Fig.7 Gate-Charge Characteristics**



**Fig.8 Breakdown Voltage Variation vs. Temperature**

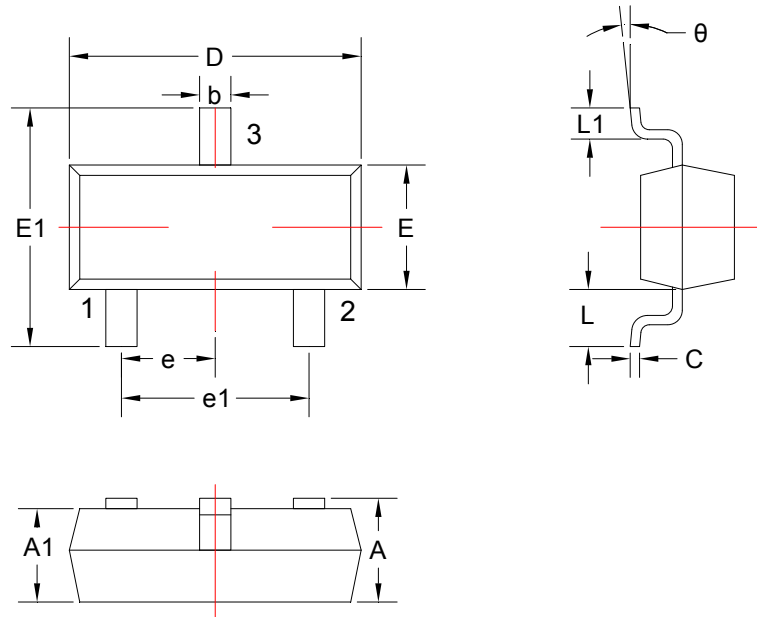


**Fig.9 Threshold Voltage Variation with Temperature**



**Fig.10 Capacitance vs. Drain-Source Voltage.**

**8. Dimension and Patterns (SOT-23)**



Units: mm

Symbol	Dimensions		Symbol	Dimensions	
	Min.	Max.		Min.	Max.
A	0.900	1.150	E1	2.250	2.550
A1	0.900	1.050	e	0.950TYP	
b	0.300	0.500	e1	1.800	2.000
c	0.080	0.150	L	0.550REF	
D	2.800	3.00	L1	0.300	0.500
E	1.200	1.400	θ	0°	8°



**Note:**

1. Controlling dimension: in millimeters
2. General tolerance: ±0.05mm
3. The pad layout is for reference only
4. Unit: mm

**DISCLAIMER**

ELECSUPER PROVIDES TECHNICAL AND RELIABILITY DATA (INCLUDING DATASHEETS), DESIGN RESOURCES (INCLUDING REFERENCE DESIGNS), APPLICATION OR OTHER DESIGN ADVICE, SAFETY INFORMATION, AND OTHER RESOURCES “AS IS” AND WITH ALL FAULTS, AND DISCLAIMS ALL WARRANTIES, EXPRESS AND IMPLIED, INCLUDING WITHOUT LIMITATION ANY IMPLIED WARRANTIES OF MERCHANTABILITY, FITNESS FOR A PARTICULAR PURPOSE OR NON-INFRINGEMENT OF THIRD PARTY INTELLECTUAL PROPERTY RIGHTS.

These resources are intended for skilled developers designing with ElecSuper products. You are solely responsible for

- (1) selecting the appropriate ElecSuper products for your application;
- (2) designing, validating and testing your application;
- (3) ensuring your application meets applicable standards, and any other safety, security, or other requirements.

These resources are subject to change without notice. ElecSuper grants you permission to use these resources only for development of an application that uses the ElecSuper products described in the resource. Other reproduction and display of these resources are prohibited. No license is granted to any other ElecSuper intellectual property right or to any third party intellectual property right. ElecSuper disclaims responsibility for, and you will fully indemnify ElecSuper and its representatives against, any claims, damages, costs, losses, and liabilities arising out of your use of these resources. ElecSuper's products are provided subject to ElecSuper's Terms of Sale or other applicable terms available either on [www.elecsuper.com](http://www.elecsuper.com) or provided in conjunction with such ElecSuper products. ElecSuper's provision of these resources does not expand or otherwise alter ElecSuper's applicable warranties or warranty disclaimers for ElecSuper products.