



GSA4737H12-F26-6P

The GSA4737H12-F26-6P is a miniature, high-performance, low power, top port silicon digital microphone with a single bit PDM output. Using proven high performance SiSonic™ MEMS technology, the GSA4737H12-F26-6P consists of an acoustic sensor, a low noise input buffer, and a sigma-delta modulator. These devices are suitable for applications such as cellphones, smart phones, laptop computers, sensors, digital still cameras, portable music recorders, and other portable electronic devices where excellent audio performance and RF immunity are required. The increased sensitivity and high Signal-to-Noise-Ratio (SNR) of the GSA4737H12-F26-6P also enhances the performance of far-field applications and many complex, multi-microphone algorithms.

Features:

- Low Noise
- High Sensitivity
- Low Current
- RF Shielded
- PDM Output
- Supports Dual Multiplexed Channels
- Ultra-Stable Performance
- Standard SMD Reflow
- Omnidirectional



GSA4737H12-F26-6P

1. ABSOLUTE MAXIMUM RATINGS

Parameter	Absolute Maximum Rating	Units
V _{DD} , DATA to Ground	-0.3, +5.0	V
CLOCK to Ground	-0.3, +5.0	V
SELECT to Ground	-0.3, +5.0	V
Input Current	±5	mA
Short Circuit Current to/from DATA	Indefinite to Ground or V _{DD}	sec
Temperature Range	-40 to +100	°C

Stresses exceeding these “Absolute Maximum Ratings” may cause permanent damage to the device. These are stress ratings only. Functional operation at these or any other conditions beyond those indicated under “Acoustic & Electrical Specifications” is not implied. Exposure beyond those indicated under “Acoustic & Electrical Specifications” for extended periods may affect device reliability.

2. ACOUSTIC & ELECTRICAL SPECIFICATIONS

TEST CONDITIONS: 23 ±2°C, 55±20% R.H., V_{DD}=1.8 V, F_{CLOCK}=2.4 MHz, SELECT pin grounded, no load, unless otherwise indicated

Parameter	Symbol	Conditions	Min	Typ	Max	Units
Supply Voltage ¹	V _{DD}		1.6	-	3.6	V
Supply Current ^{1,2,3}	I _{DD}		-	500	600	μA
Sleep Current ³	I _{SLEEP}	F _{CLOCK} < 1 kHz	-	25	50	μA
Sensitivity ¹	S	94 dB SPL @ 1 kHz	-23	-26	-29	dBFS
Signal to Noise Ratio	SNR	94 dB SPL @ 1 kHz, A-weighted	60	61.5	-	dB(A)
Total Harmonic Distortion	THD	94 dB SPL @ 1 kHz, S = Typ	-	0.25	0.35	%
Acoustic Overload Point	AOP	10% THD @ 1 kHz, S = Typ	112	115	-	dB SPL
Power Supply Rejection Ratio	PSRR	200 mVpp sinewave @ 1 kHz	-	48	-	dBV /FS
Power Supply Rejection	PSR	100 mVpp square wave @ 217 Hz, A-weighted	-	-80	-	dBFS (A)
DC Output		Fullscale = ±100	-	4	-	% FS
Directivity			Omnidirectional			
Polarity		Increasing sound pressure	Decreasing density of 1's			
Data Format			½ Cycle PDM			
Logic Input High	V _{IH}		0.65xV _{DD}	-	3.6	V



GSA4737H12-F26-6P

Parameter	Symbol	Conditions	Min	Typ	Max	Units
Logic Input Low	V_{IL}		-0.3	-	$0.35 \times V_{DD}$	V
Logic Output High	V_{OH}	$I_{OUT} = 1 \text{ mA}$	$0.65 \times V_{DD}$	-	V_{DD}	V
Logic Output Low	V_{OL}	$I_{OUT} = 1 \text{ mA}$	0	-	$0.35 \times V_{DD}$	V
SELECT (high)			$V_{DD} - 0.2$	-	3.6	V
SELECT (low)			-0.3	-	0.2	V
Short Circuit Current	I_{SC}	Grounded DATA pin	-	1	10	mA
Output Load	C_{LOAD}		-	-	100	pF
Clock Frequency	F_{CLOCK}		1.0	-	3.25	MHz
Clock Duty Cycle			40	-	60	%
Clock Rise/Fall Time	t_{EDGE}		-	-	10	ns
Fall-asleep Time ^{4,5}		$F_{CLOCK} < 1 \text{ kHz}$	-	-	10	ms
Wake-up Time ^{4,6}		$F_{CLOCK} \geq 1 \text{ MHz}$	-	-	10	ms
Delay Time for Valid Data	t_{DV}	$C_{LOAD} = 13 \text{ pf}$	18	-	60	ns
Delay Time for High Z	t_{DZ}		0	-	16	ns

¹ 100% tested.

² I_{DD} varies with C_{LOAD} according to: $\Delta I_{DD} = 0.5 \times V_{DD} \times \Delta C_{LOAD} \times F_{CLOCK}$.

³ Maximum specifications are measured at maximum V_{DD} . Typical specifications are measured at standard test conditions.

⁴ Valid microphones states are: Powered Down Mode (mic off), Sleep Mode (low current, DATA = high-Z, fast startup), and Active Mode (normal operation).

⁵ Time from $F_{CLOCK} < 1 \text{ kHz}$ to I_{SLEEP} specification is met when transitioning from Active Mode to Sleep Mode.

⁶ Time from $F_{CLOCK} \geq 1 \text{ MHz}$ to all applicable specifications are met when transitioning from Sleep Mode to Active Mode.



GSA4737H12-F26-6P

3. MICROPHONE STATE DIAGRAM

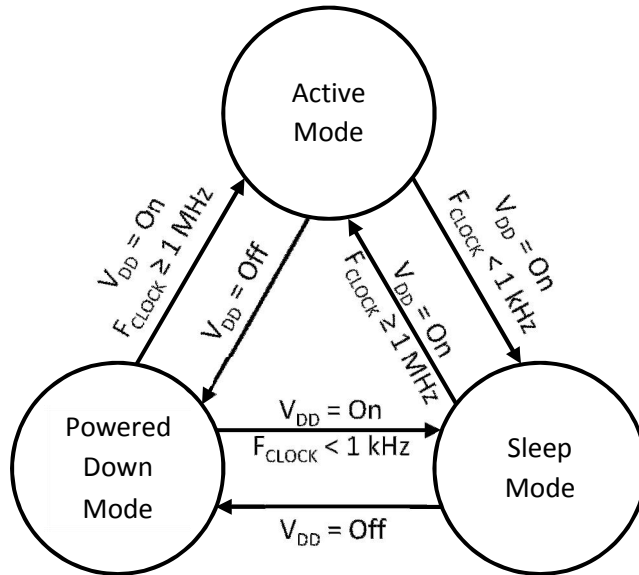



GSA4737H12-F26-6P

4. FREQUENCY RESPONSE CURVE

Typical Free Field Response
Normalized to 1kHz

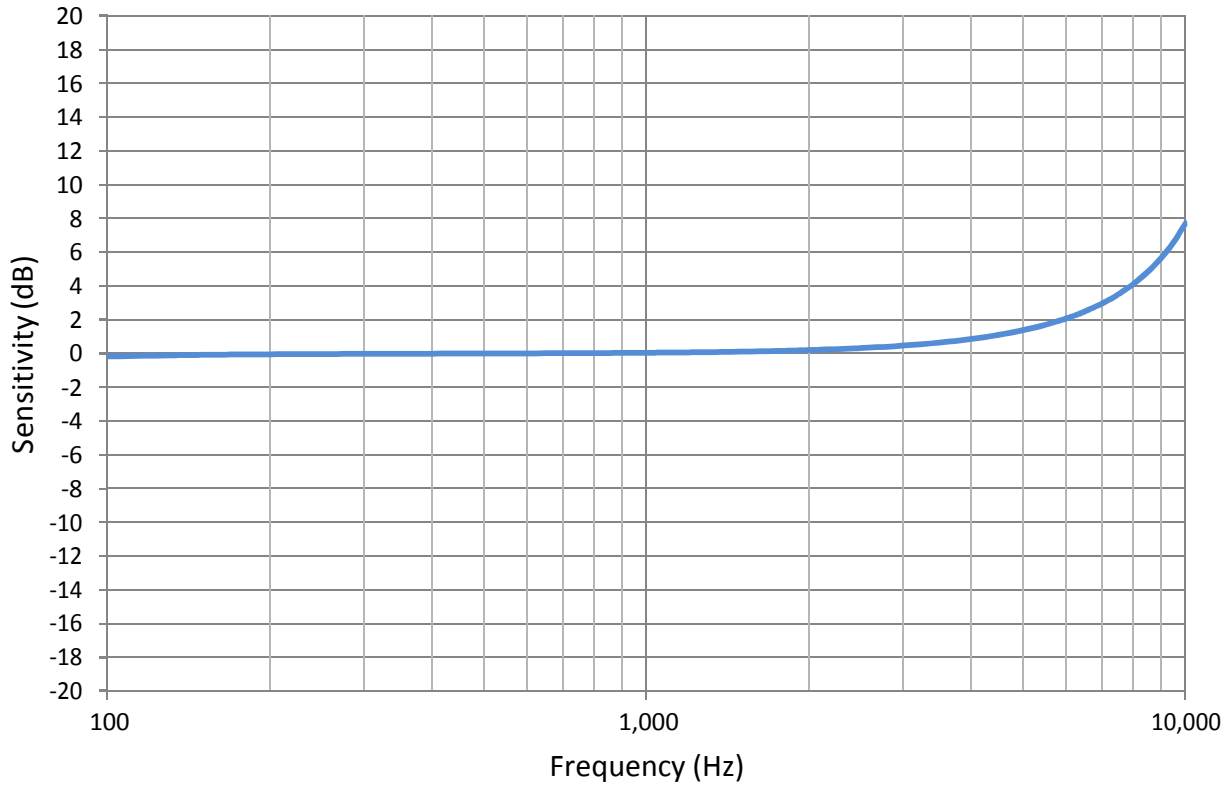



GSA4737H12-F26-6P

5. INTERFACE CIRCUIT

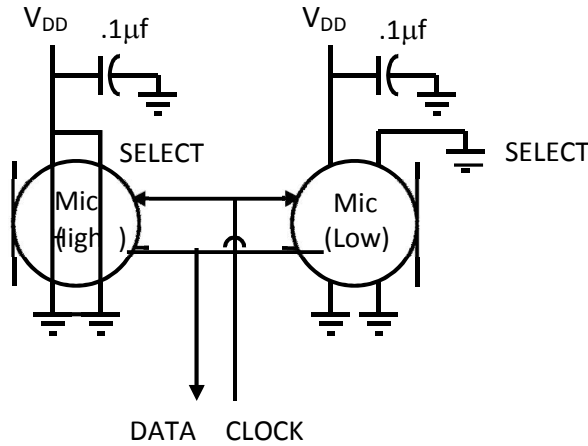

Microphone	SELECT	Asserts DATA On	Latch DATA On
Mic (High)	V _{DD}	Rising Clock Edge	Falling Clock Edge
Mic (Low)	GND	Falling Clock Edge	Rising Clock Edge

Note: All Ground pins must be connected to ground.

Capacitors near the microphone should not contain Class 2 dielectrics.

Detailed information on acoustic, mechanical, and system integration can be found in the latest *SiSonic™ Design Guide* application note.

6. TIMING DIAGRAM

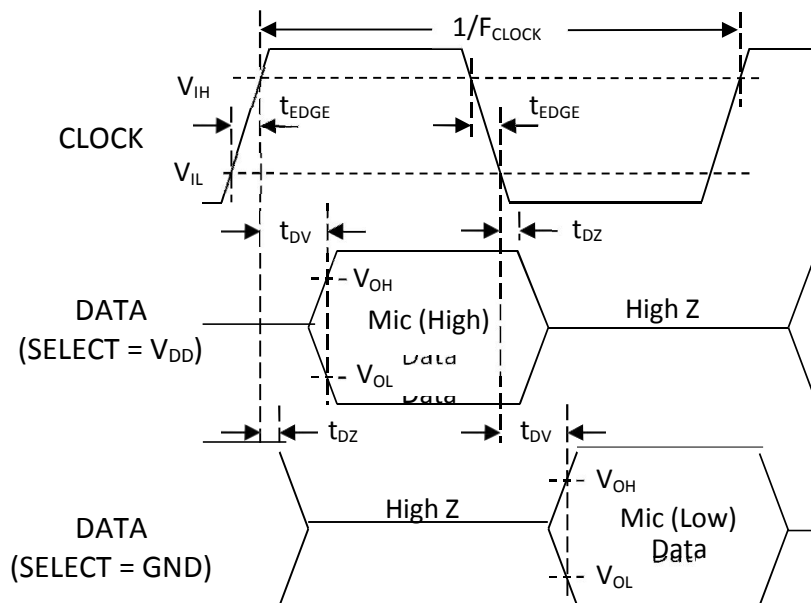



GSA4737H12-F26-6P

7. MECHANICAL SPECIFICATIONS

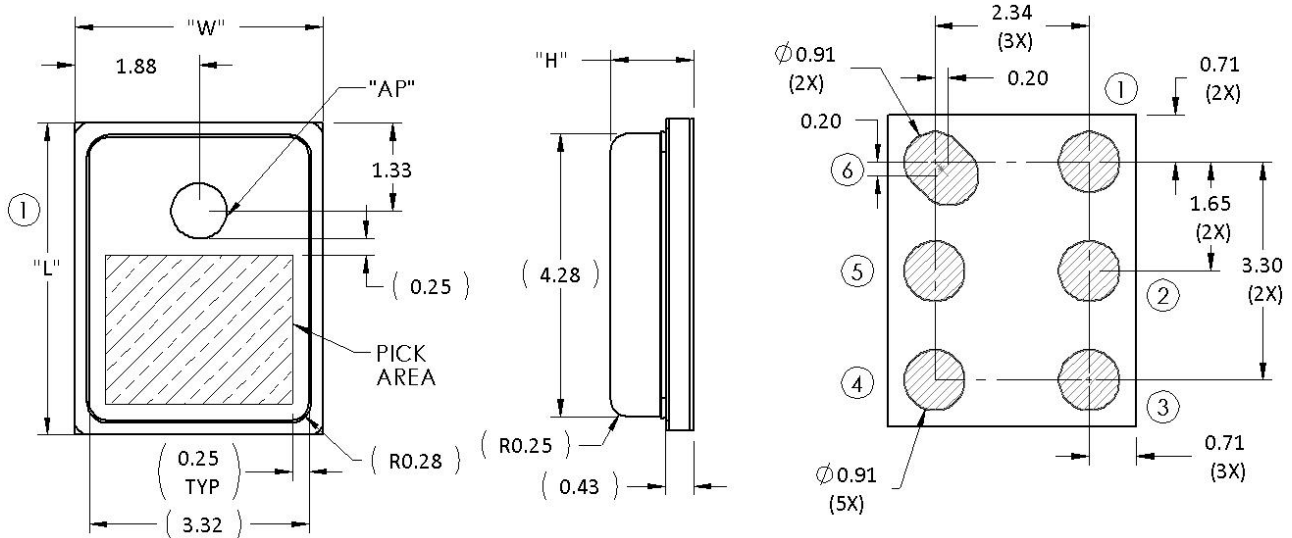

Item	Dimension	Tolerance	Units
Length (L)	4.72	±0.10	mm
Width (W)	3.76	±0.10	mm
Height (H)	1.25	±0.10	mm
Acoustic Port (AP)	∅0.84	±0.05	mm

Pin #	Pin Name	Type	Description
1	GROUND	Power	Ground
2	SELECT	Non-Digital Input	Lo/Hi (L/R) Select This pin is internally pulled low.
3	GROUND	Power	Ground
4	CLOCK	Digital I	Clock Input
5	DATA	Digital O	PDM Output
6	V _{DD}	Power	Power Supply

Notes: Pick Area only extends to 0.25 mm of any edge or hole unless otherwise specified.

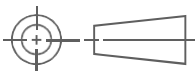

Dimensions are in millimeters unless otherwise specified. Tolerance is ±0.15mm unless otherwise specified



GSA4737H12-F26-6P

8. EXAMPLE LAND PATTERN

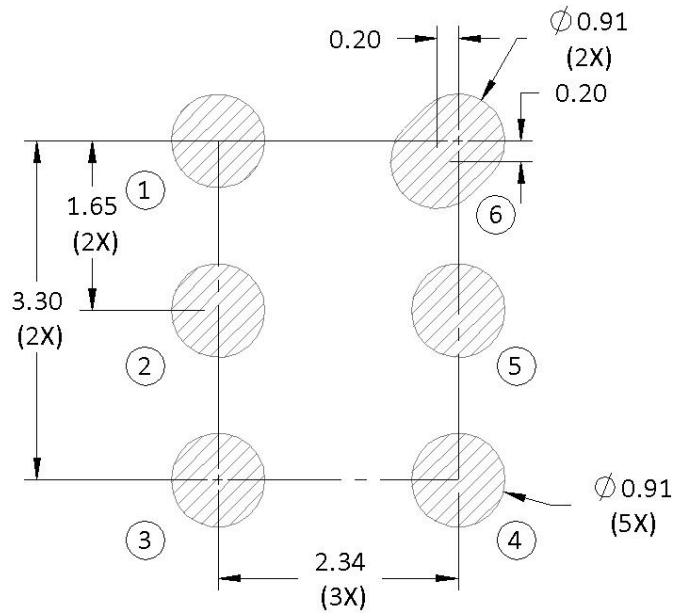

9. EXAMPLE SOLDER STENCIL PATTERN

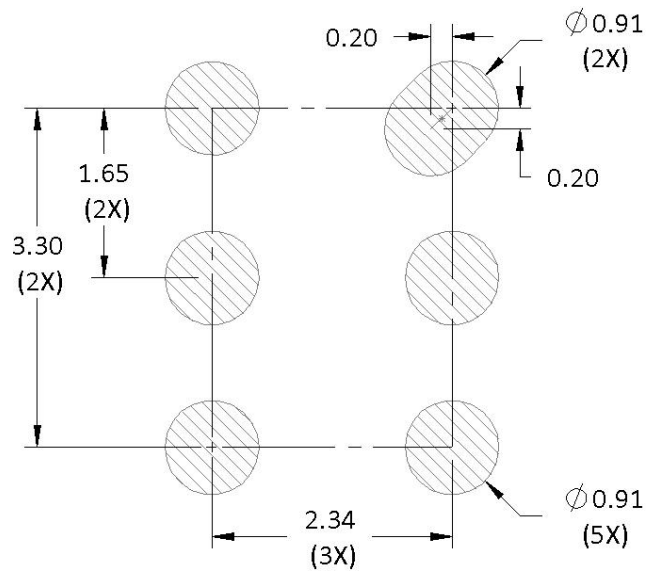

Notes: Dimensions are in millimeters unless otherwise specified.
Further optimizations based on application should be performed.



GSA4737H12-F26-6P

10. PACKAGING & MARKETING DETAIL

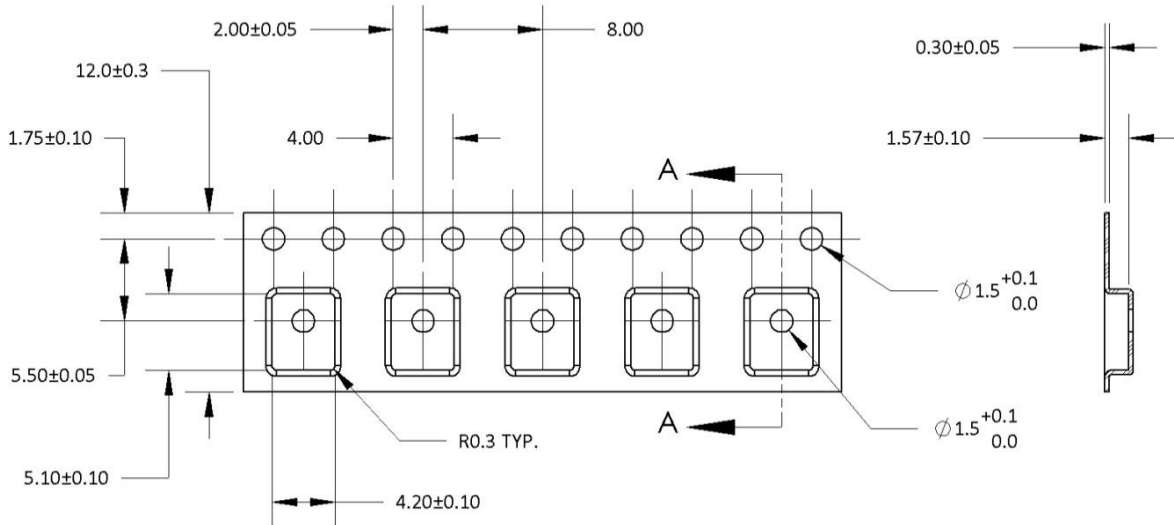

Model Number	Suffix	Reel Diameter	Quantity Per Reel
JSM4737T6P263	-6	13"	4800

Notes: Dimensions are in millimeters unless otherwise specified.

Vacuum pickup only in the pick area indicated in Mechanical Specifications.

Tape & reel per EIA-481.

Labels applied directly to reel and external package.

Shelf life: Twelve (12) months when devices are to be stored in factory supplied, unopened ESD moisture sensitive bag under maximum environmental conditions of 30°C, 70% R.H.



GSA4737H12-F26-6P

11. RECOMMENDED REFLOW PROFILE

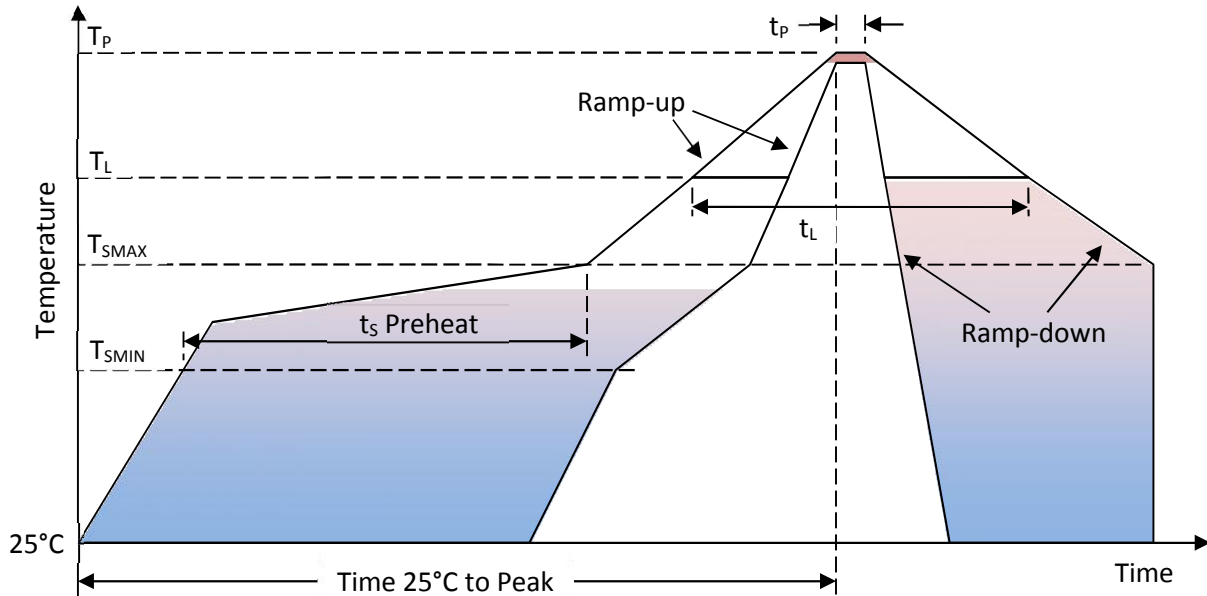

Profile Feature	Pb-Free
Average Ramp-up rate ($T_{S\text{MAX}}$ to T_P)	3°C/second max.
Preheat <ul style="list-style-type: none"> Temperature Min ($T_{S\text{MIN}}$) Temperature Max ($T_{S\text{MAX}}$) Time ($T_{S\text{MIN}}$ to $T_{S\text{MAX}}$) (t_s) 	150°C 200°C 60-180 seconds
Time maintained above: <ul style="list-style-type: none"> Temperature (T_L) Time (t_L) 	217°C 60-150 seconds
Peak Temperature (T_P)	260°C
Time within 5°C of actual Peak Temperature (t_p)	20-40 seconds
Ramp-down rate (T_P to $T_{S\text{MAX}}$)	6°C/second max
Time 25°C to Peak Temperature	8 minutes max

Notes: Based on IPC/JDEC J-STD-020 Revision C.

All temperatures refer to topside of the package, measured on the package body surface.



GSA4737H12-F26-6P

12. ADDITIONAL NOTES

(A) MSL (moisture sensitivity level) Class 1.

(B) Maximum of 3 reflow cycles is recommended.

(C) In order to minimize device damage:

- Do not board wash or clean after the reflow process.
- Do not brush board with or without solvents after the reflow process.
- Do not directly expose to ultrasonic processing, welding, or cleaning.
- Do not insert any object in port hole of device at any time.
- Do not apply over 30 psi of air pressure into the port hole.
- Do not pull a vacuum over port hole of the microphone.
- Do not apply a vacuum when repacking into sealed bags at a rate faster than 0.5 atm/sec.

13. MATERIALS STATEMENT

Meets the requirements of the European RoHS directive, 2011/65/EC as amended.

Meets the requirements of the industry-standard IEC 61249-2-21:2003 for halogenated substances and Green Materials Standards Policy section on Halogen-Free.

Ozone depleting substances are not used in the product or the processes used to make the product including compounds listed in annex A, B, and C of the “Montreal Protocol on Substances that deplete the ozone Layer.”



GSA4737H12-F26-6P

14. RELIABILITY SPECIFICATIONS

Test	Description
Thermal Shock	100 cycles air-to-air thermal shock from -40°C to +125°C with 15 minute soaks. (IEC 68-2-4)
High Temperature Storage	1,000 hours at +105°C environment (IEC 68-2-2 Test Ba)
Low Temperature Storage	1,000 hours at -40°C environment (IEC 68-2-2 Test Aa)
High Temperature Bias	1,000 hours at +105°C under bias (IEC 68-2-2 Test Ba)
Low Temperature Bias	1,000 hours at -40°C under bias (IEC 68-2-2 Test Aa)
Temperature / Humidity Bias	1,000 hours at +85°C/85% R.H. under bias. (JESD22-A101A-B)
Vibration	4 cycles of 20 to 2,000 Hz sinusoidal sweep with 20 G peak acceleration lasting 12 minutes in X, Y, and Z directions. (Mil-Std-883E, Method 2007.2 A)
ESD-HBM	3 discharges of ±2 kV direct contact to I/O pins. (MIL 883E, Method 3015.7)
ESD-LID/GND	3 discharges of ±8 kV direct contact to lid while unit is grounded. (IEC 61000-4-2)
ESD-MM	3 discharges of ±200 V direct contact to I/O pins. (ESD STM5.2)
Reflow	5 reflow cycles with peak temperature of +260°C
Mechanical Shock	3 pulses of 10,000 G in the X, Y, and Z direction (IEC 68-2-27, Test Ea)

Note: After reliability tests are performed, the sensitivity of the microphones shall not deviate more than 3 dB from its initial value.



GSA4737H12-F26-6P

15. SPECIFICATIONS REVISIONS

Revision	Specification Changes	Date
A	Initial Release (C10113410)	2/16/12
B	Released in new format; update specifications; new JIN designation; new RoHS statement (C10114438)	12/05/12
C	Make PSRR a positive number; updated humidity conditions and ESD descriptions (C10114466); fixed typos in Reliability Section 14 (C10114690)	3/27/13
D	Corrected PSRR units; update C _{LOAD} value for t _{DV} (C10114972)	06/18/13

Information contained herein is subject to change without notice. It may be used by a party at their own discretion and risk. We do not guarantee any results or assume any liability in connection with its use. This publication is not to be taken as a license to operate under any existing patents.