

Features

- 2 μ A Ground Current at no Load
- $\pm 2\%$ Output Accuracy
- 200mA Output Current
- Wide Operating Input Voltage Range: 2V to 50V
- Dropout Voltage: 0.65V at 100mA ($V_{OUT}=5V$)
- Support Fixed Output Voltage 1.8V, 3.3V, 5V, 9V, 12V
- Stable with Ceramic or Tantalum Capacitor
- Current Limit Protection
- Over-Temperature Protection
- SOT-23-5 Package Available

Applications

- Portable, Battery Powered Equipment
- Low Power Microcontrollers
- Laptop, Palmtops and PDAs
- Wireless Communication Equipment
- Audio/Video Equipment
- Car Navigation Systems
- Industrial Controls
- Weighting Scales
- Meters
- Home Automation

General Description

The TP573C is a low-dropout (LDO) voltage regulators with enable function offering the benefits of high input voltage, low-dropout voltage, low-power consumption, and miniaturized packaging.

The features of low quiescent current as low as 2 μ A and zero disable current is ideal for powering the battery equipment to a longer service life. The TP573C

is stable with the ceramic output capacitor over its wide input range from 2V to 50V and the entire range of output load current.

Ordering Information

TP573CADJS5

S5:SOT23-5 Package

Output voltage: ADJ
(SNS)VFB=1.2V

PIN CONFIGURATION

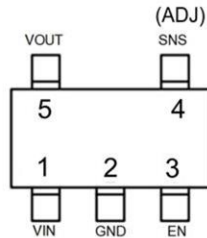

Pin No	Pin Name	Pin Function
2	GND	Ground
5	VOUT	Output of the Regulator
1	VIN	Input of Supply Voltage.
3	EN	Enable Control Input.
4	SNS	Sense of Output Voltage.

TYPICAL APPLICATION

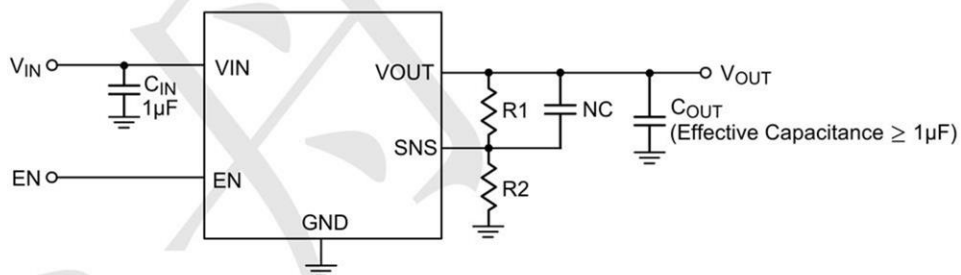
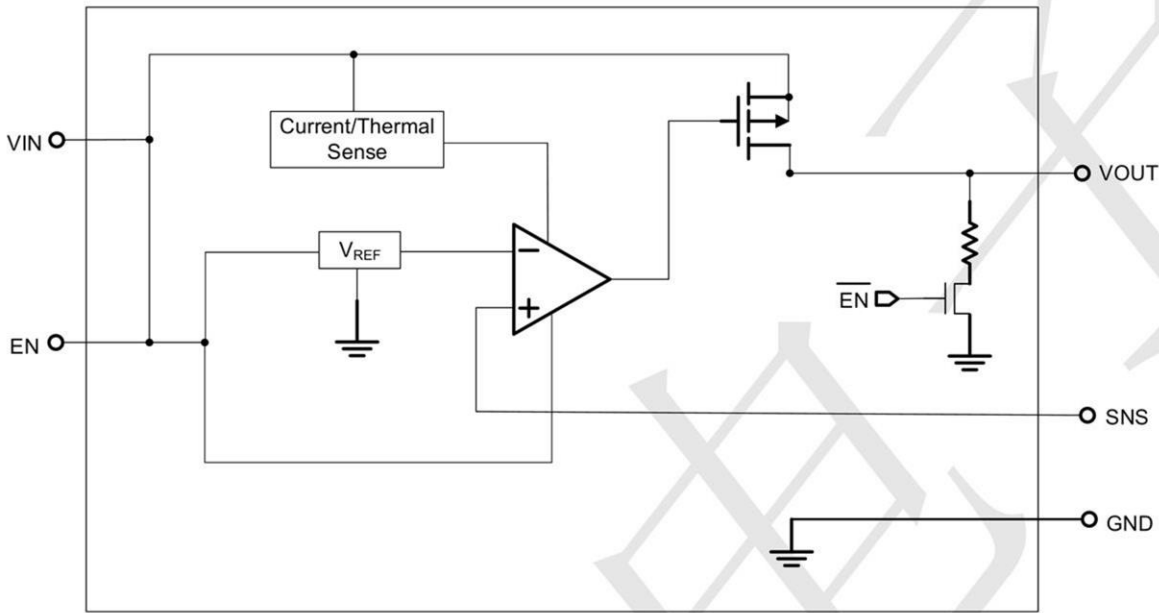

Figure 3. Adjustable Output Voltage Application Circuit

$$R_1 = R_2 \times \left(\frac{V_{OUT}}{1.2V} - 1 \right) \quad \text{where } R_2 < 24K\Omega$$



Absolute Maximum Ratings

VIN Pin to GND Pin Voltage	-0.3V to 60V
VOUT Pin to GND Pin Voltage TP573CA1, B2 ,S5	-0.3V to 14V
TP573C18 ,33,50 S5	-0.3V to 6.0V
VOUT Pin to VIN Pin Voltage	-40V to 0.3V
Storage Temperature Range	-60°C~150°C
Lead Temperature (Soldering, 10 sec)	260°C
Junction Temperature	150°C
Operating Ambient Temperature Range T_A	-40°C~85°C
SOT-23-5, θ_{JA}	218.1°C/W
SOT-23-5, θ_{JC}	28.5°C/W
(Assume no Ambient Airflow, no Heatsink)	

Recommended Operating Conditions

Supply Input Voltage	3.5V to 50V
Junction Temperature Range	-40°C to 125°C
Ambient Temperature Range	-40°C to 85°C

Electrical Characteristics

($V_{IN}=15V$, $V_{EN}=5V$, $T_A=25^{\circ}C$, unless otherwise specified) (Note 1)

Parameter	Symbol	Test Conditions	Min	Typ	Max	Unit
Supply Voltage	V_{IN}		2	--	50	V
DC Output Voltage Accuracy	V_{SNS}	$I_{LOAD} = 0.1mA$	1.176	1.2	1.224	%
Dropout Voltage ($I_{LOAD} = 100mA$)	V_{DROP}	$V_{OUT} \geq 5V$	--	0.66		V
	$V_{DROP_3.3V}$	$V_{OUT} = 3.3V$		0.75		
	$V_{DROP_1.8V}$	$V_{OUT} = 1.8V$		1		
Ground Current ($I_{LOAD} = 0mA$)	I_Q	$V_{OUT} \leq 5V$		2	3.5	μA
	I_{QH}	$5V < V_{OUT} \leq 12V$		5	8	
Shutdown Ground Current	I_{SD}	$V_{EN} = 0V$, $V_{OUT} = 0V$		0.01	0.5	μA
V_{OUT} Shutdown Leakage Current	I_{LEAK}			0.01	0.5	μA
Enable Threshold Voltage	V_{IH}	EN Rising			2	V
	V_{IL}	EN Falling	0.6			
EN Input Current	I_{EN}	$V_{EN} = 36V$		10		nA
Line Regulation	$\Delta LINE$	$I_{LOAD} = 1mA$, $5 \leq V_{IN} \leq 36V$	--	0.3		%
Load Regulation	$\Delta LOAD$	$1mA \leq I_{LOAD} \leq 0.2A$		0.1		%
Output Current Limit	I_{LIM}	$V_{OUT} = 0$	200	300		mA
Power Supply Rejection Ratio	PSRR	$V_{OUT} = 5V$, $I_{LOAD} = 1mA$, $V_{IN} = 12V$, $f = 100Hz$		70		dB
Thermal Shutdown Temperature	T_{SD}	$I_{LOAD} = 10mA$	--	160	--	$^{\circ}C$
Thermal Shutdown Hysteresis	ΔT_{SD}				15	$^{\circ}C$



Typical Operating Characteristics

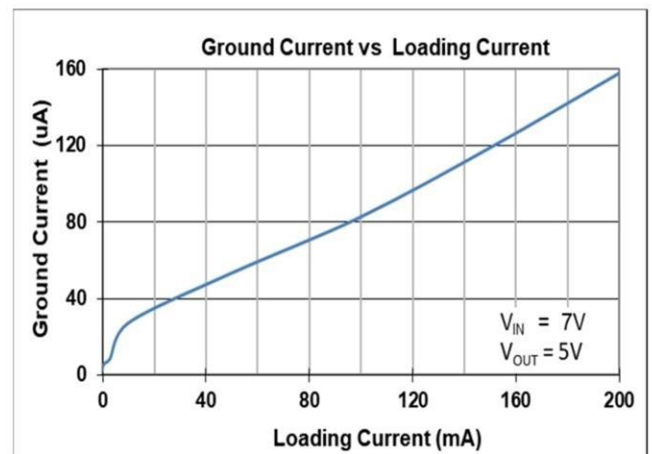
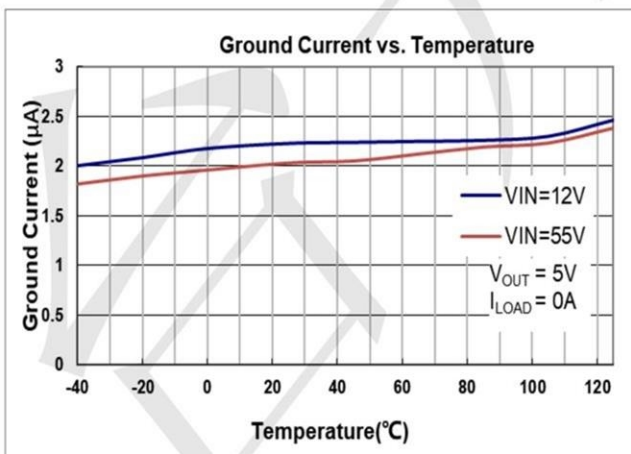
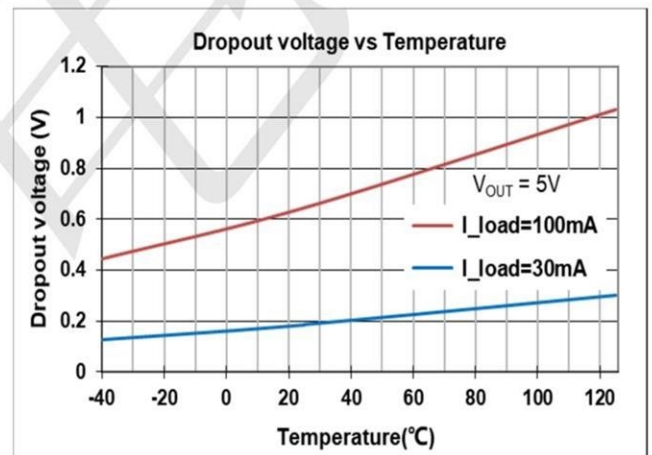
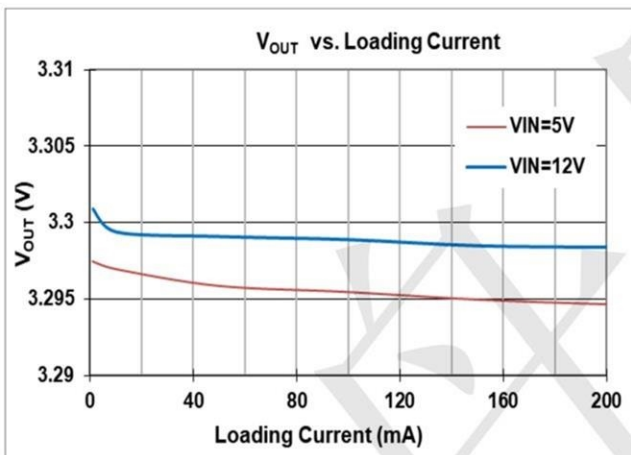
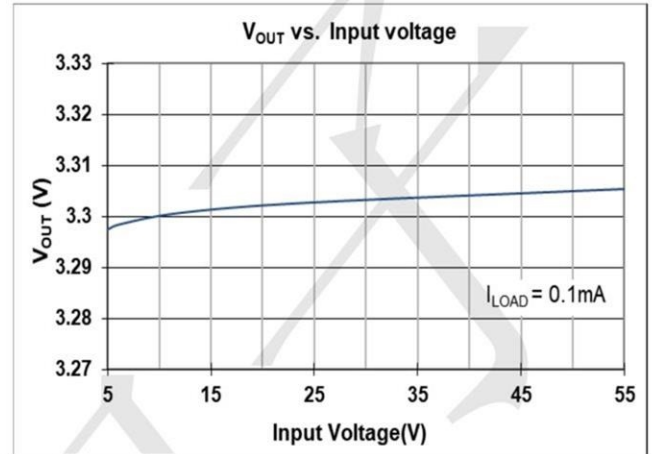
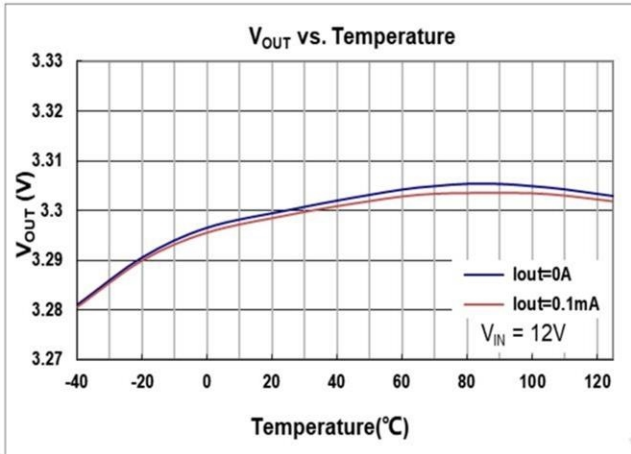



SHDN Leakage Input Current vs. Temp.

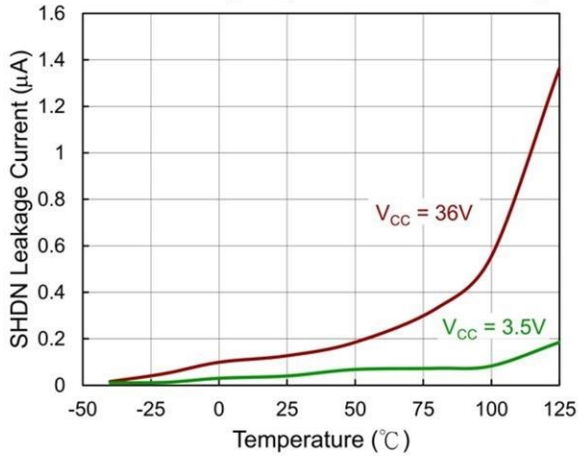

Enable Threshold vs. Supply Voltage

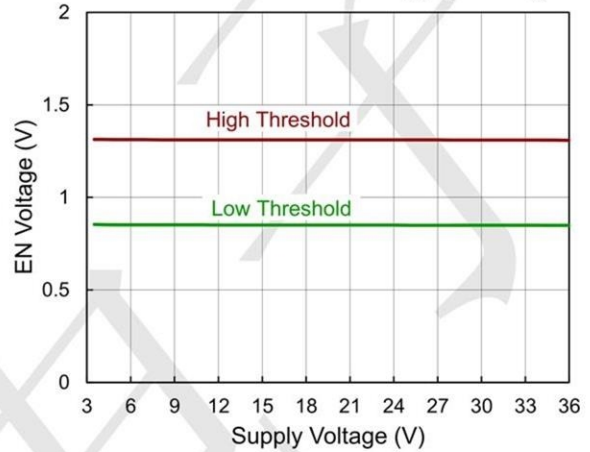

Enable Threshold vs. Temperature

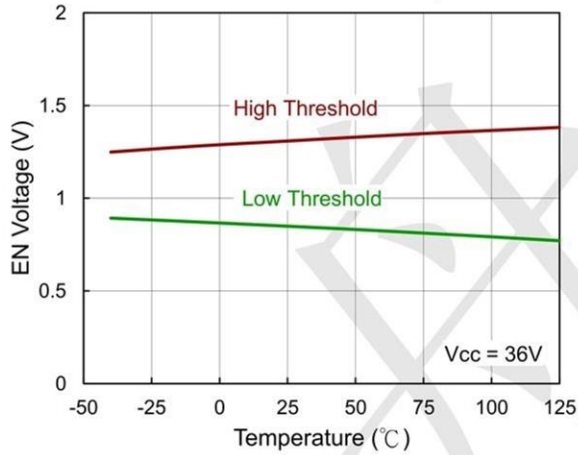

Dropout Voltage vs. Temperature

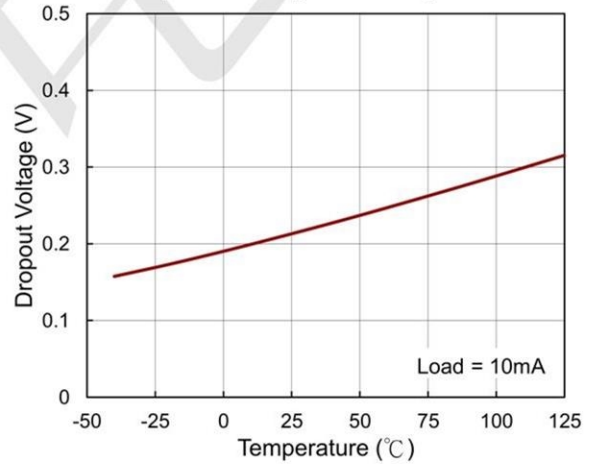

Current Limit vs. Temperature

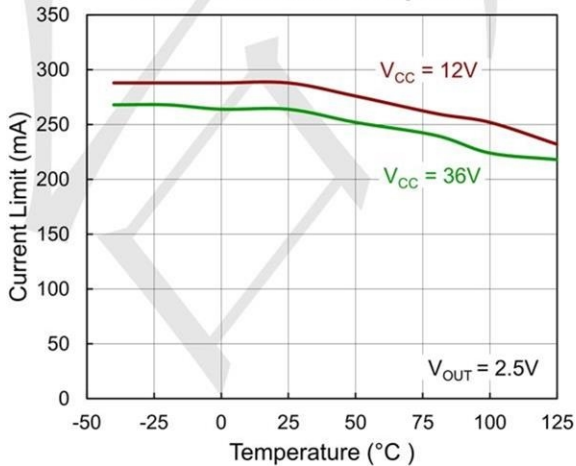

PSRR vs. Frequency

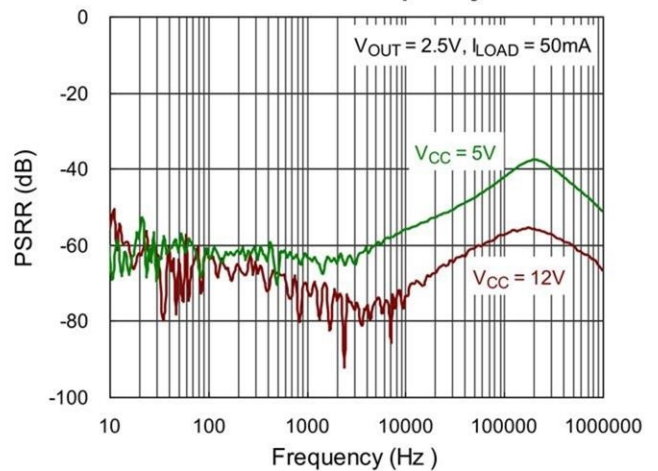



TECH PUBLIC

— 台 丹 电 子 —

TP573CADJS5

50V,200mA,2uA, Higt PSRR Voltage Regulator

www.sot23.com.tw

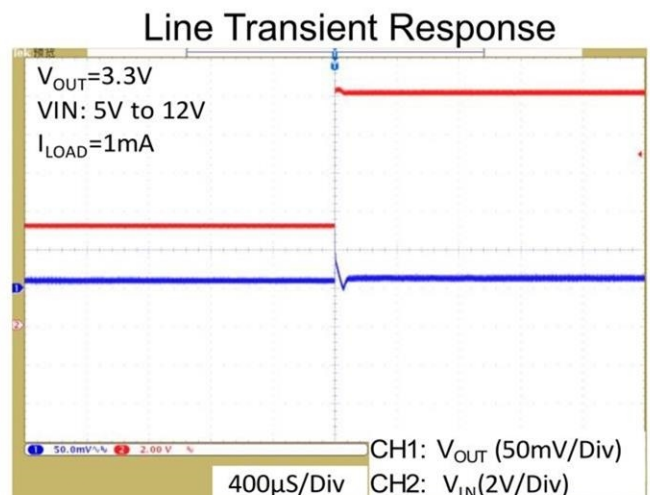
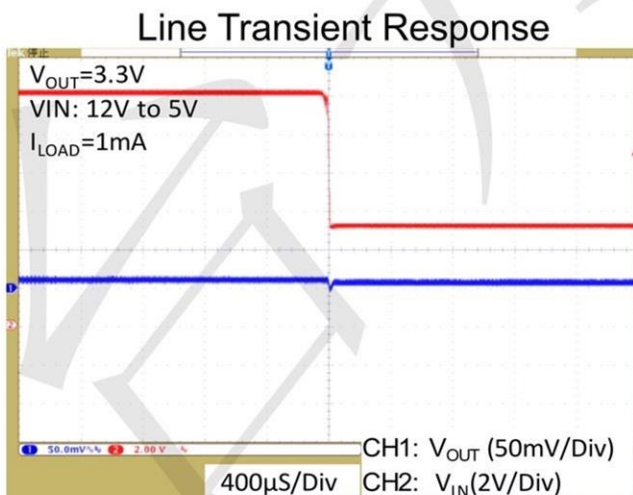
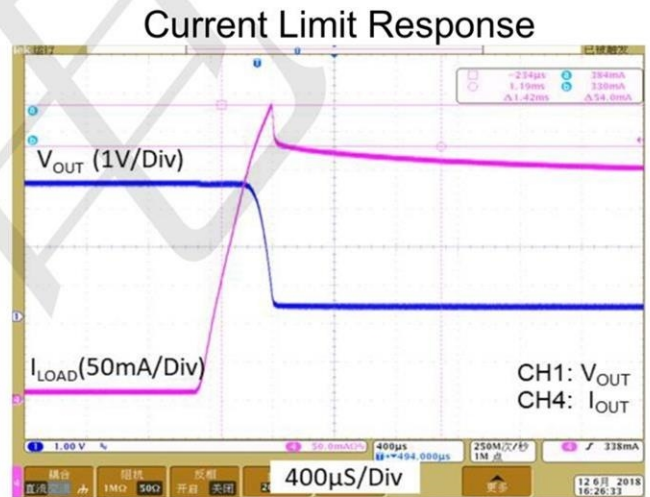
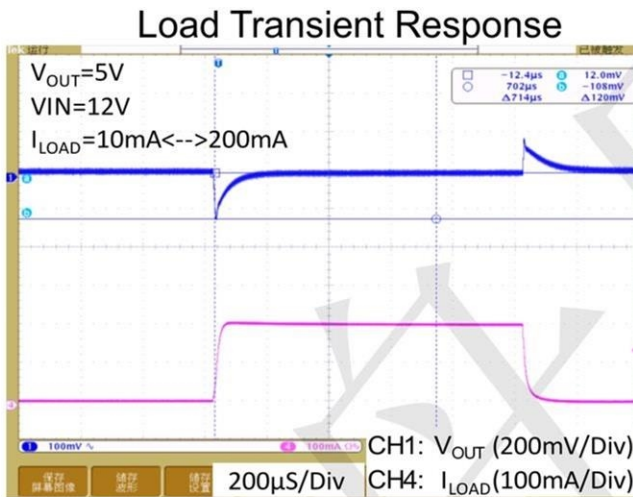
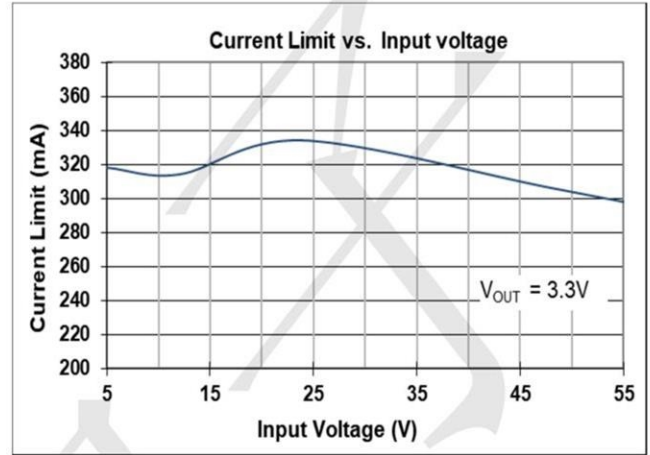
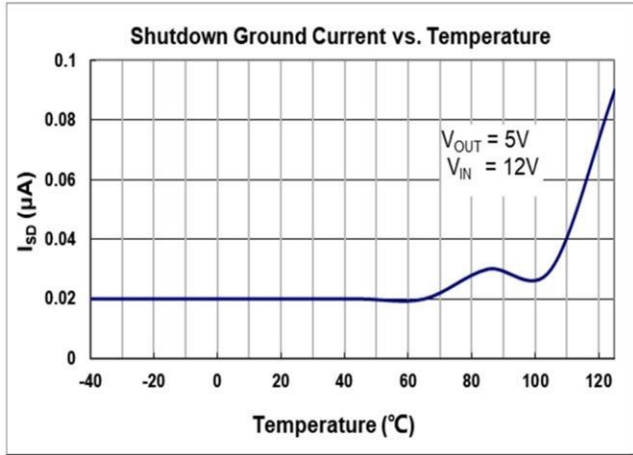



TECH PUBLIC

—台丹电子—

TP573CADJS5

50V,200mA,2uA, Higt PSRR Voltage Regulator

www.sot23.com.tw

V_{OUT} Turn on by V_{IN} Quick Power Up

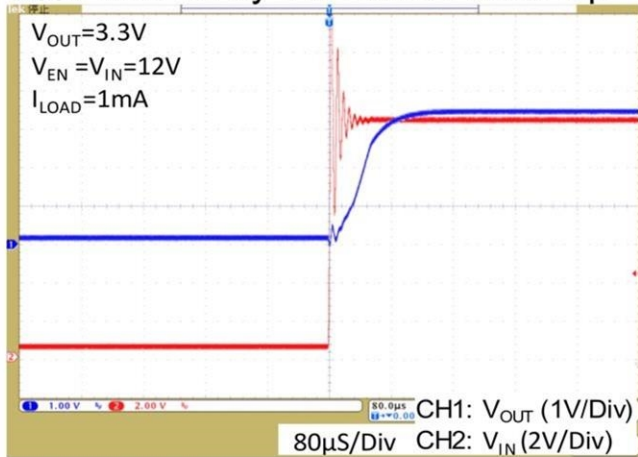

V_{OUT} Turn On by EN

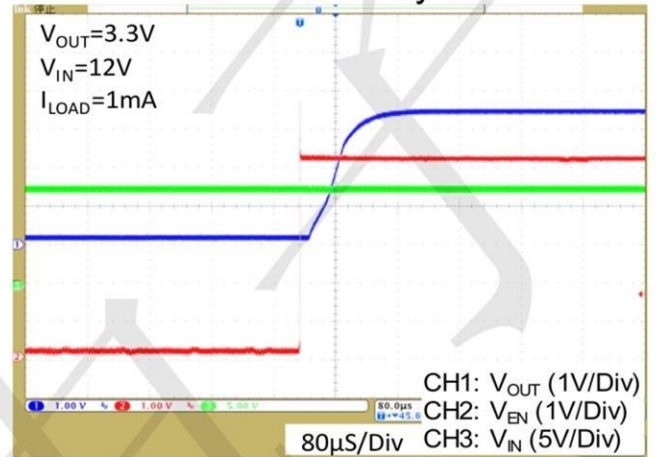

Application Guideline

Input and Output Capacitor Requirements

The external input and output capacitors of TP573CADJS5 must be properly selected for stability and performance. Use a 1μF or larger input capacitor and place it close to the IC's VIN and GND pins. Any output capacitor meeting the minimum 1mΩ ESR (Equivalent Series Resistance) and effective capacitance between 1μF and 22μF requirement may be used. Place the output capacitor close to the IC's VOUT and GND pins. Increasing capacitance and decreasing ESR can improve the circuit's PSRR and line transient response.

Current Limit

The TP573CADJS5 contain the current limiter of output power transistor, which monitors and controls the transistor, limiting the output current to 1100mA (typical).

The output can be shorted to ground indefinitely without damaging the part.

Dropout Voltage

The TP573CADJS5 use a PMOS pass transistor to achieve low dropout. When (VIN – VOUT) is less than the dropout voltage (VDROP), the PMOS pass device is in the linear region of operation and the input-to-output resistance is the RDS(ON) of the PMOS pass element. VDROP scales approximately with the output current because the PMOS device behaves as a resistor in dropout condition.

As any linear regulator, PSRR and transient response are degraded as (VIN – VOUT) approaches dropout condition.

Adjustable Output Voltage Application

TP573CADJS5 by SNS pin also can work as an adjustable output voltage LDO. Figure 1 gives the connections for the adjustable output voltage application. The resistor divider from VOUT to SNS sets the output voltage when in regulation.

The voltage on the SNS pin sets the output voltage and is determined by the values of R1 and R2. To keep a good temperature coefficient of output voltage, the values of R1 and R2 should be selected carefully to ignore the temperature effect of input current at the SNS pin. A current greater than 50μA in the resistor divider is recommended to meet the above requirement. The adjustable output voltage can be calculated using the formula given in equation 1:

$$V_{OUT} = \frac{R1+R2}{R2} \times SNS \quad (1)$$

where VSNS is determined by the output voltage selections in the ordering information of

The minimum recommended 50μA in the resistor divider makes the application no longer a 2μA low quiescent LDO.

OTP (Over Temperature Protection)

The over temperature protection function of TP573CADJS5 series will turn off the P-MOSFET when the junction temperature exceeds 155°C (typ.). Once the junction temperature cools down by approximately 15°C, the regulator will automatically resume operation.

Thermal Application

For continuous operation, do not exceed the absolute maximum junction temperature. The maximum power dissipation depends on the thermal resistance of the IC package, PCB layout, rate of surrounding airflow, and difference between junction and ambient temperature. The maximum power dissipation can be calculated as below:

$T_A=25^{\circ}\text{C}$, TECH PUBLIC PCB,

The max PD (Max) = $(125^{\circ}\text{C} - 25^{\circ}\text{C}) / (200^{\circ}\text{C}/\text{W}) = 0.5\text{W}$ for SOT-23-5 package.

Power dissipation (PD) is equal to the product of the output current and the voltage drop across the output pass element, as shown in the equation below:

$$\text{PD} = (\text{VIN} - \text{VOUT}) \times \text{IOUT}$$

Layout Consideration

By placing input and output capacitors on the same side of the PCB as the LDO, and placing them as close as is practical to the package can achieve the best performance. The ground connections for input and output capacitors must be back to the TP573CADJS5 ground pin using as wide and as short of a copper trace as is practical. Connections using long trace lengths, narrow trace widths, and/or connections through via must be avoided. These add parasitic inductances and resistance that results in worse performance especially during transient conditions.



TECH PUBLIC

—台丹电子—

TP573CADJS5

50V,200mA,2uA, Higt PSRR Voltage Regulator

www.sot23.com.tw

Package informantion

SOT23-5

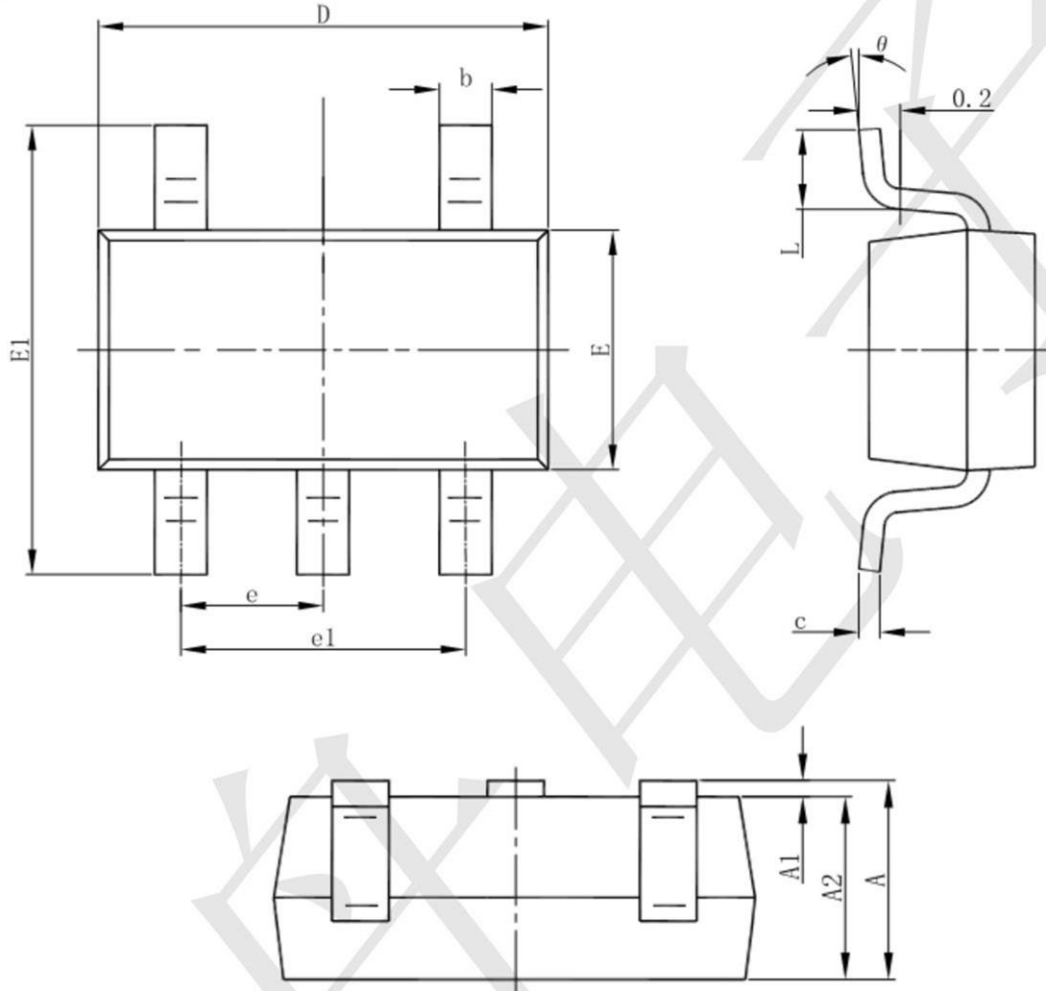

Symbol	Dimensions In Millimeters		Dimensions In Inches	
	Min	Max	Min	Max
A	1.050	1.250	0.041	0.049
A1	0.000	0.100	0.000	0.004
A2	1.050	1.150	0.041	0.045
b	0.300	0.500	0.012	0.020
c	0.100	0.200	0.004	0.008
D	2.820	3.020	0.111	0.119
E	1.500	1.700	0.059	0.067
E1	2.650	2.950	0.104	0.116
e	0.950(BSC)		0.037(BSC)	
e1	1.800	2.000	0.071	0.079
L	0.300	0.600	0.012	0.024
θ	0°	8°	0°	8°

WWW.TECHPUBLIC.COM.TW