

# KBP4005-KBP410/G

Single Phase 4.0Amp Glass passivated Bridge Rectifiers

## Features

- Rating to 1000V PRV
- Idea for printed circuit board
- Reliable low cost construction utilizing molded plastic technique
- The plastic material has UL flammability classification 94V-0
- The G suffix is uses for photoresist chip, otherwise it is a knife scraping chip

## Package

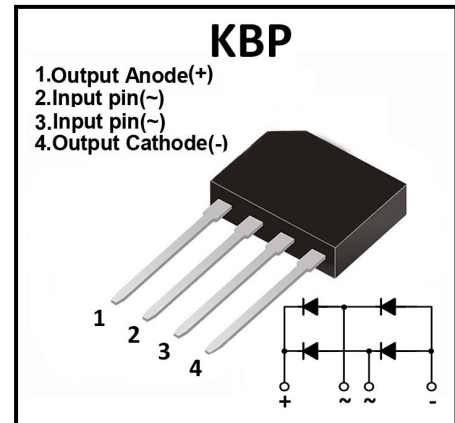

## MECHANICAL DATA

- Polarity : As marked on body
- Weight : 0.05 ounces, 1.52 grams
- Mounting position : Any

## Maximum Ratings And Electrical Characteristics (@T<sub>A</sub>=25°C unless otherwise noted)

Symbol	Parameter	KBP 4005	KBP 401	KBP 402	KBP 404	KBP 406	KBP 408	KBP 410	Unit	
V <sub>RRM</sub>	Maximum repetitive peak reverse voltage	50	100	200	400	600	800	1000	V	
V <sub>RMS</sub>	Maximum RMS voltage	35	70	140	280	420	560	700	V	
V <sub>DC</sub>	Maximum DC blocking voltage	50	100	200	400	600	800	1000	V	
I <sub>AV</sub>	Maximum average forward rectified(With heatsink) current @T <sub>C</sub> =105°C(Without heatsink)					4.0				A
I <sub>FSM</sub>	Peak Forward Surge Current@T <sub>J</sub> =25°C 8.3ms single half sine-wave @T <sub>J</sub> =125°C					120				A
V <sub>F</sub>	Maximum forward voltage at 4.0A DC					1.10				V
I <sub>R</sub>	Maximum DC reverse current@T <sub>J</sub> =25°C at rated DC blocking voltage@ T <sub>J</sub> =125°C					5.0				uA
I <sub>t</sub> <sup>2</sup>	I <sub>t</sub> <sup>2</sup> Rating for fusing (3ms≤t≤8.3ms)					59.76				A <sub>S</sub> <sup>2</sup>
C <sub>J</sub>	Typical junction capacitance (Note 1)					40				pF
R <sub>θJC</sub>	Typical thermal resistance					6				°C/W
R <sub>θJL</sub>	(Unit mounted on 30mmx30mmx1mm Copper plate heatsink.)					8				
R <sub>θJA</sub>						15				
R <sub>θJC</sub>	Typical thermal resistance					14				°C/W
R <sub>θJL</sub>	(without heatsink)					20				
R <sub>θJA</sub>						40				
T <sub>J</sub>	Operation Temperature Range					-55 to +150			°C	
T <sub>STG</sub>	Storage Temperature Range					-55 to +150				

Note:(1)Measured at 1MHz and applied reverse voltage of 4.0V D.C.



**Ratings And Characteristic Curves**

**Figure 1: FORWARD CURRENT DERATING CURVE**

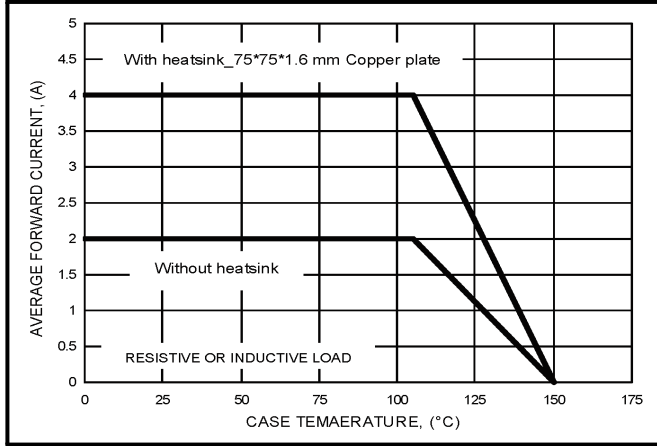

**Figure 2: MAXIMUM NON-REPETITIVE SURGE CURRENT**

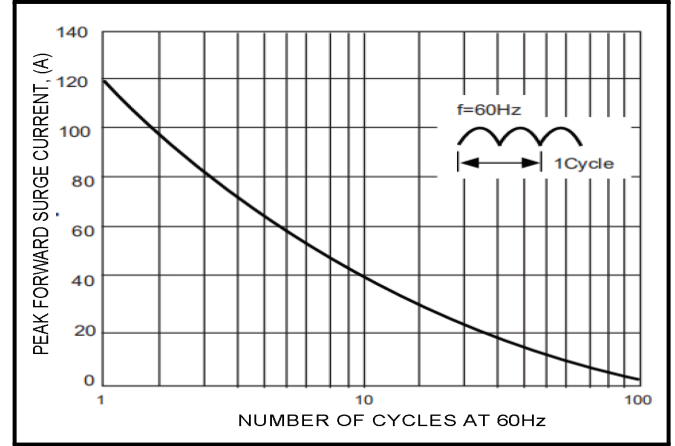

**Figure 3: TYPICAL JUNCTION CAPACITANCE**

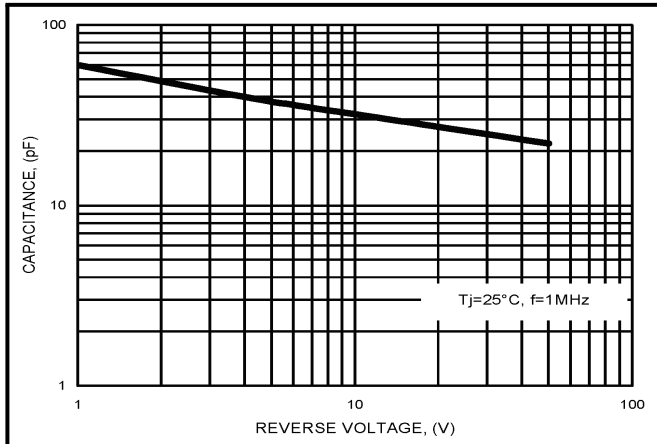

**Figure 4: TYPICAL FORWARD CHARACTERISTICS**

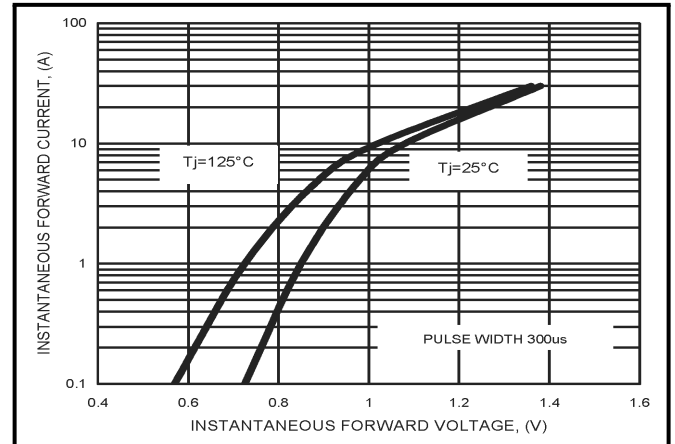

**Figure 5: TYPICAL REVERSE CHARACTERISTICS**

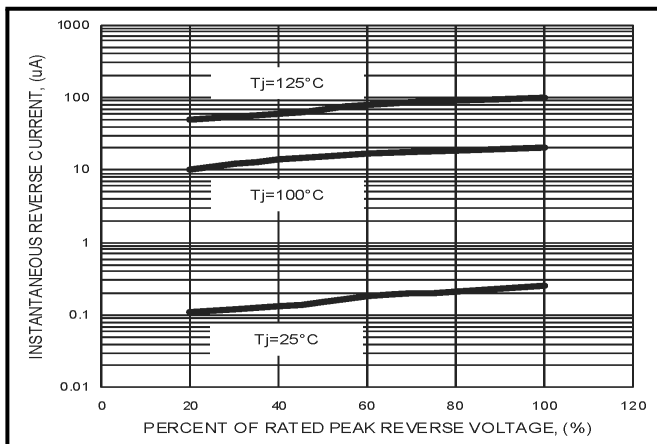

**KBP4005-KBP410/G**

Single Phase 4.0Amp Glass passivated Bridge Rectifiers

Outline Drawing -KBP

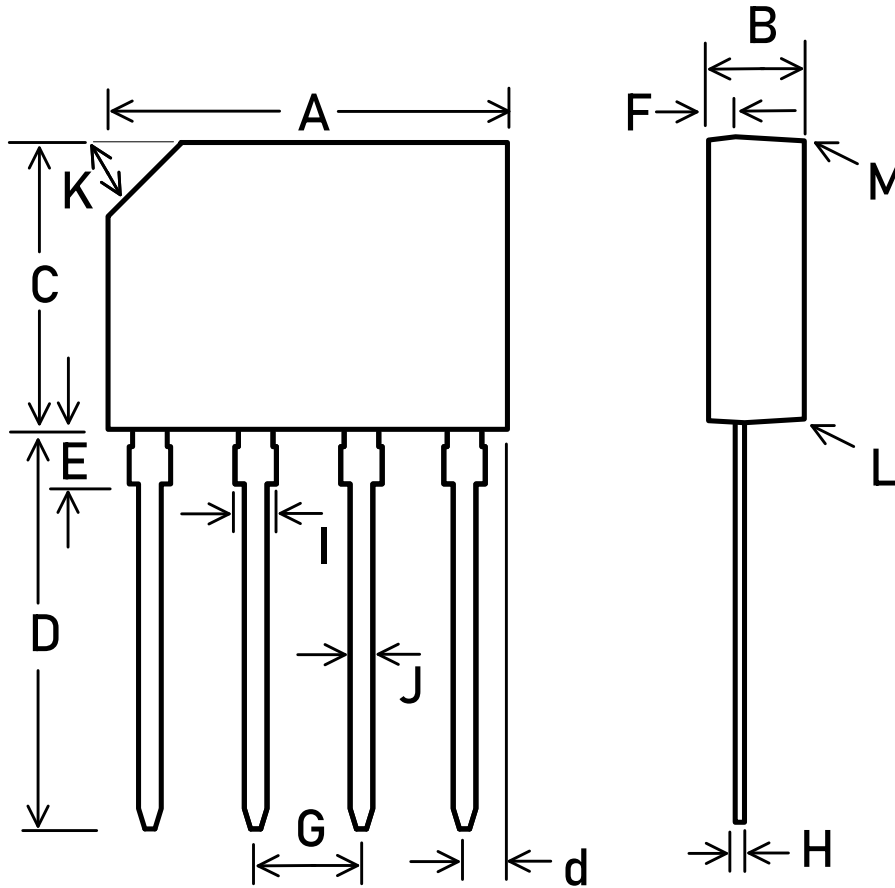

SYMBOL	MILLIMETER	
	MIN.	MAX.
A	14.2	14.7
B	3.30	3.60
C	10.2	10.6
D	13.8	14.4
d	1.40	1.70
E	1.80	2.20
F	0.80	1.10
G	3.71	3.91
H	0.30	0.55
I	1.22	1.42
J	0.76	0.86
K	2.7 x 45°	
L	-	3°
M	-	2°

