

Description

The HSU120P03 is the high cell density trenched P-ch MOSFETs, which provide excellent R_{DS(ON)} and gate charge for most of the synchronous buck converter applications.

The HSU120P03 meet the RoHS and Green Product requirement, 100% EAS guaranteed with full function reliability approved.

- Super Low Gate Charge
- 100% EAS Guaranteed
- Green Device Available
- Excellent CdV/dt effect decline
- Advanced high cell density Trench technology

Product Summary

V _{DS}	-30	V
R _{DS(ON),typ}	3.1	mΩ
I _D	-120	A

TO252 Pin Configuration

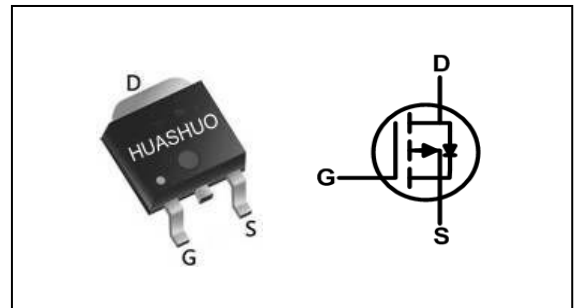

Absolute Maximum Ratings

Symbol	Parameter	Rating	Units
V _{DS}	Drain-Source Voltage	-30	V
V _{GS}	Gate-Source Voltage	±20	V
I _D @T _C =25°C	Continuous Drain Current, V _{GS} @ -10V ^{1,6}	-120	A
I _D @T _C =100°C	Continuous Drain Current, V _{GS} @ -10V ^{1,6}	-89	A
I _{DM}	Pulsed Drain Current ²	-504	A
EAS	Single Pulse Avalanche Energy ³	576	mJ
P _D @T _C =25°C	Total Power Dissipation ⁴	107	W
T _{STG}	Storage Temperature Range	-55 to 150	°C
T _J	Operating Junction Temperature Range	-55 to 150	°C

Thermal Data

Symbol	Parameter	Typ.	Max.	Unit
R _{θJA}	Thermal Resistance Junction-ambient ¹ (t ≤ 10S)	---	20	°C/W
	Thermal Resistance Junction-ambient ¹ (Steady State)	---	50	°C/W
R _{θJC}	Thermal Resistance Junction-case ¹	---	1.45	°C/W



Electrical Characteristics ($T_J=25\text{ }^\circ\text{C}$, unless otherwise noted)

Symbol	Parameter	Conditions	Min.	Typ.	Max.	Unit
BV_{DSS}	Drain-Source Breakdown Voltage	$V_{GS}=0V, I_D=-250\mu A$	-30	---	---	V
$R_{DS(ON)}$	Static Drain-Source On-Resistance ²	$V_{GS}=-10V, I_D=-20A$	---	3.1	3.9	$m\Omega$
		$V_{GS}=-4.5V, I_D=-20A$	---	4.6	6	$m\Omega$
$V_{GS(th)}$	Gate Threshold Voltage	$V_{GS}=V_{DS}, I_D=-250\mu A$	-1.0	---	-2.5	V
I_{DSS}	Drain-Source Leakage Current	$V_{DS}=-24V, V_{GS}=0V, T_J=25\text{ }^\circ\text{C}$	---	---	-1	μA
		$V_{DS}=-24V, V_{GS}=0V, T_J=55\text{ }^\circ\text{C}$	---	---	-5	μA
I_{GSS}	Gate-Source Leakage Current	$V_{GS}=\pm 20V, V_{DS}=0V$	---	---	± 100	nA
Q_g	Total Gate Charge (-10V)	$V_{DS}=-15V, V_{GS}=-10V, I_D=-20A$	---	125	---	nC
Q_{gs}	Gate-Source Charge		---	12	---	
Q_{gd}	Gate-Drain Charge		---	31	---	
$T_{d(on)}$	Turn-On Delay Time	$V_{DD}=-15V, V_{GS}=-10V, R_G=3.3\Omega, I_D=-20A$	---	14	---	ns
T_r	Rise Time		---	12	---	
$T_{d(off)}$	Turn-Off Delay Time		---	66	---	
T_f	Fall Time		---	35	---	
C_{iss}	Input Capacitance	$V_{DS}=-15V, V_{GS}=0V, f=1\text{MHz}$	---	7300	---	pF
C_{oss}	Output Capacitance		---	819	---	
C_{riss}	Reverse Transfer Capacitance		---	530	---	

Diode Characteristics

Symbol	Parameter	Conditions	Min.	Typ.	Max.	Unit
I_S	Continuous Source Current ^{1,5}	$V_G=V_D=0V, \text{Force Current}$	---	---	-120	A
V_{SD}	Diode Forward Voltage ²	$V_{GS}=0V, I_S=-1A, T_J=25\text{ }^\circ\text{C}$	---	---	-1.2	V

Note :

- 1.The data tested by surface mounted on a 1 inch² FR-4 board with 2OZ copper.
- 2.The data tested by pulsed , pulse width $\leq 300\mu s$, duty cycle $\leq 2\%$
- 3.The EAS data shows Max. rating . The test condition is $V_{DD}=-15V, V_{GS}=-10V, L=0.5mH, R_g=25R$
- 4.The power dissipation is limited by 150 $^\circ\text{C}$ junction temperature
- 5.The data is theoretically the same as I_D and I_{DM} , in real applications , should be limited by total power dissipation
- 6.The maximum current rating is package limited.



Typical Characteristics

Figure 1. Output Characteristics

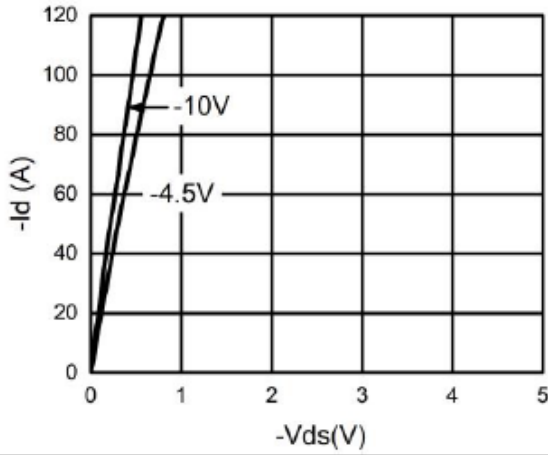

Figure 2. Transfer Characteristics

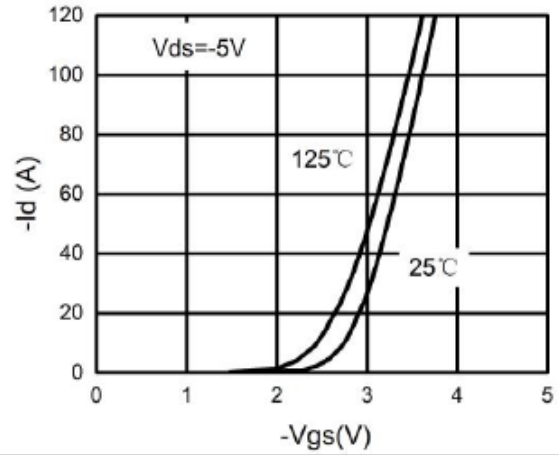

Figure 3. Power Dissipation

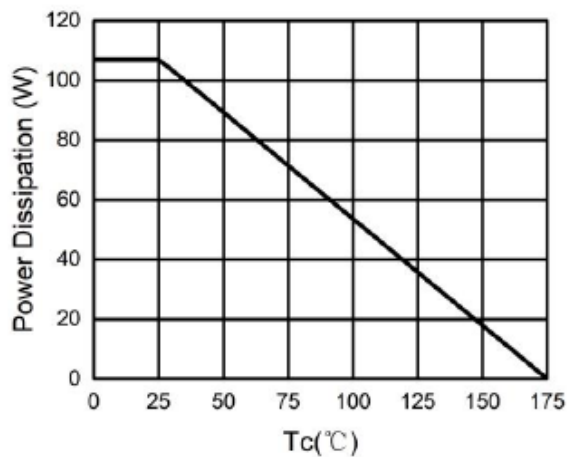

Figure 4. Drain Current

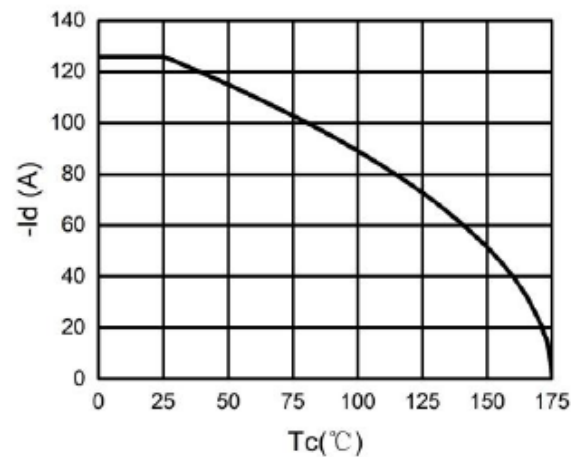

Figure 5. BV_{DSS} vs Junction Temperature

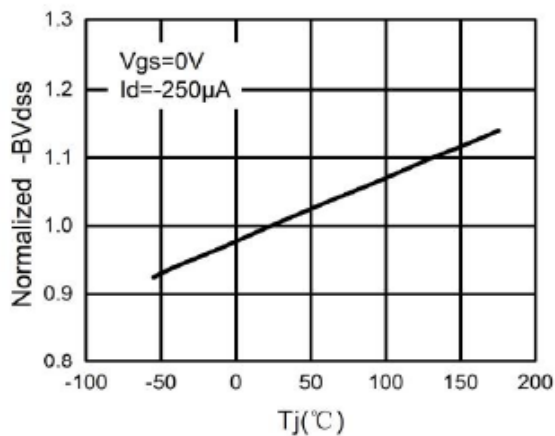

Figure 6. $R_{DS(ON)}$ vs Junction Temperature

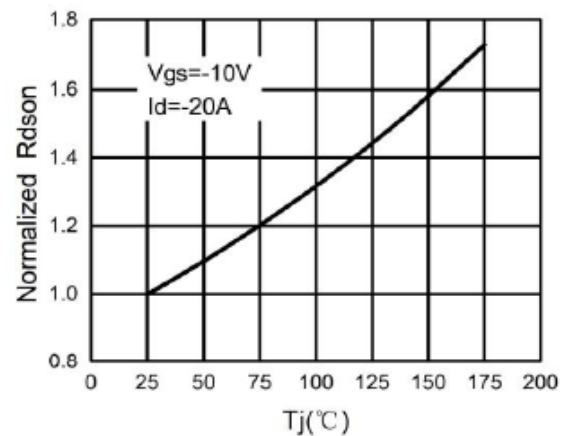



Figure 7. Gate Charge Waveforms

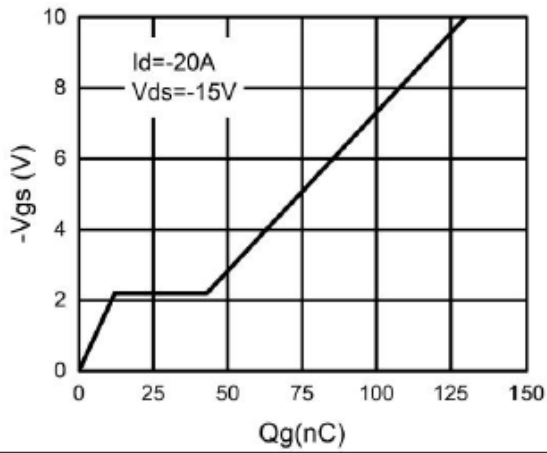

Figure 8. Capacitance

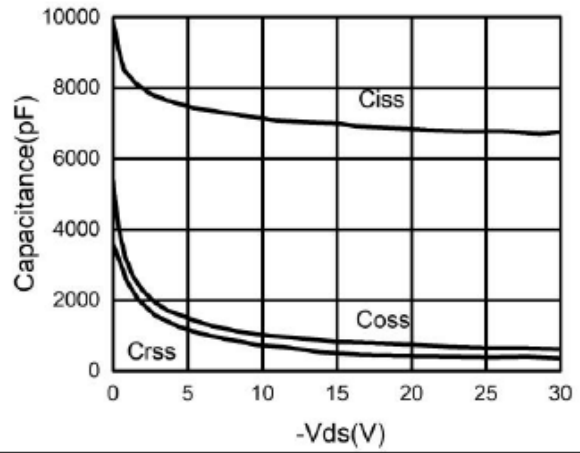

Figure 9. Body-Diode Characteristics

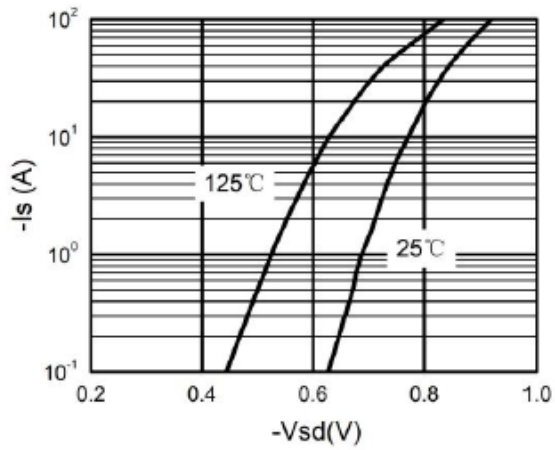
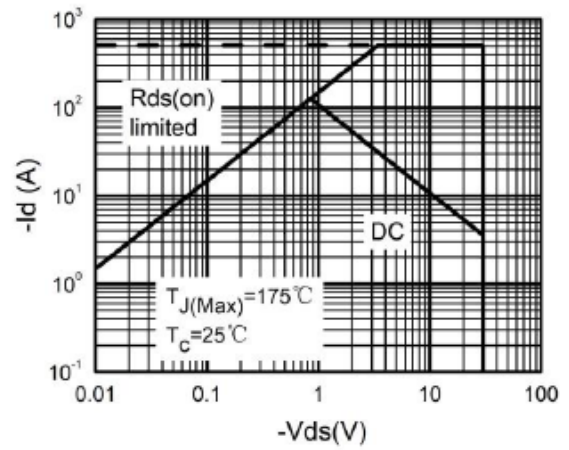

Figure 10. Maximum Safe Operating Area





Ordering Information

Part Number	Package code	Packaging
HSU120P03	TO252-2	2500/Tape&Reel

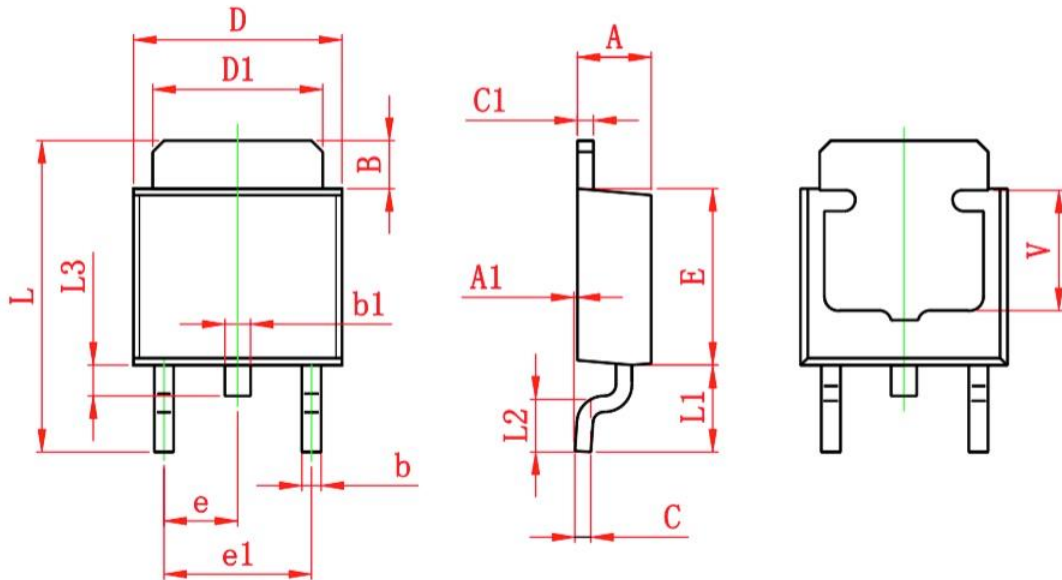

Symbol	Dimensions In Millimeters		Dimensions In Inches	
	Min.	Max.	Min.	Max.
A	2.200	2.400	0.087	0.094
A1	0.000	0.127	0.000	0.005
B	1.350	1.650	0.053	0.065
b	0.500	0.700	0.020	0.028
b1	0.700	0.900	0.028	0.035
c	0.430	0.580	0.017	0.023
c1	0.430	0.580	0.017	0.023
D	6.350	6.650	0.250	0.262
D1	5.200	5.400	0.205	0.213
E	5.400	5.700	0.213	0.224
e	2.300 TYP.		0.091 TYP.	
e1	4.500	4.700	0.177	0.185
L	9.500	9.900	0.374	0.390
L1	2.550	2.900	0.100	0.114
L2	1.400	1.780	0.055	0.070
L3	0.600	0.900	0.024	0.035
V	3.800 REF.		0.150 REF.	