

版次 (REV)	变更编号 (ECN NO)	说明 (DESCRIPTION)	日期 (DATE)	核准 (APPD)
X1		初版发行		

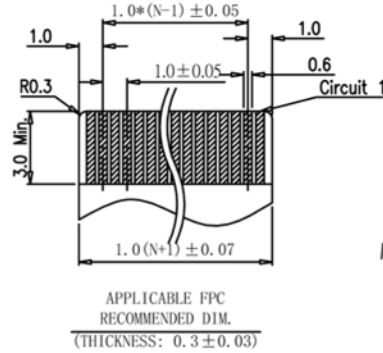
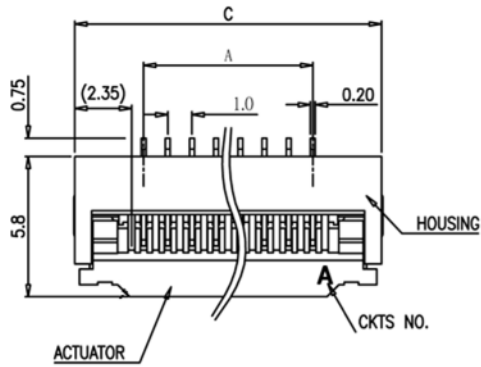

旧料号

88065-XXX X X X  
PIN数

电镀: 1镀金 2镀雾锡 3镀亮锡

包材: A管装 B袋装 C盒装 D卷装

NO	胶体材质	锁扣材质	胶体颜色	锁扣颜色	柱子
1	LCP	LCP	本色	黑色	
2	PA9T	LCP	本色	黑色	

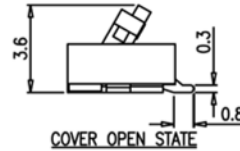
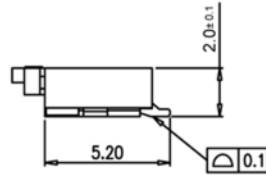
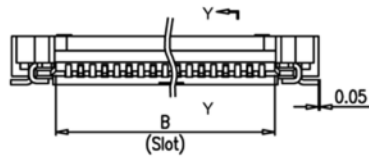

新料号

1010A\*-\*\*\*-\*\*\*

1:17P插8针 2:53P插26针  
3:9P插4针 4:13P插6针

PIN数  
1:LCP 2: PA9T  
P:盘装 G:管装  
1:雾锡2: 亮锡3: 镀金

Electrical

Voltage:50 V AC(rms)/DC  
Current:0.5 A AC(rms)/DC  
Contact Resistance:40 mΩ max(initial)  
Dielectric Withstanding Voltage:200 V AC/rms  
Insulation Resistance:800 MΩ min  
Operating Temp:-25° C~+85° C

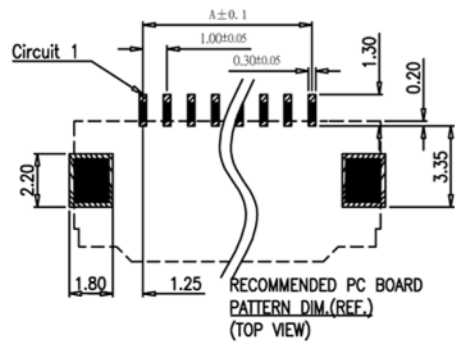
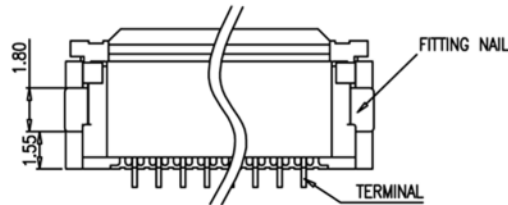
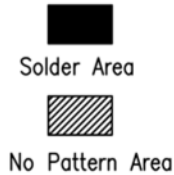

CKT	Dim A	Dim B	Dim C
004	3.00	5.06	8.70
005	4.00	6.06	9.70
006	5.00	7.06	10.70
007	6.00	8.06	11.70
008	7.00	9.06	12.70
009	8.00	10.06	13.70
010	9.00	11.06	14.70
011	10.00	12.06	15.70
012	11.00	13.06	16.70
013	12.00	14.06	17.70
014	13.00	15.06	18.70
015	14.00	16.06	19.70
016	15.00	17.06	20.70
017	16.00	18.06	21.70
018	17.00	19.06	22.70
019	18.00	20.06	23.70
020	19.00	21.06	24.70
021	20.00	22.06	25.70
022	21.00	23.06	26.70
023	22.00	24.06	27.70
024	23.00	25.06	28.70
025	24.00	26.06	29.70
026	25.00	27.06	30.70
027	26.00	28.06	31.70
028	27.00	29.06	32.70
029	28.00	30.06	33.70
030	29.00	31.06	34.70

使用类别 (EXTEND USE) 0.5mm掀盖 FPC H=2.0 **P插**针		品名 (TITLE) 1.0-NP翻盖 H=2.0		图号 (DWG NO):	
尺寸公差 DIMENSION ±0.30 .0 ±0.20 .00 ±0.10 .000 ±0.05		角度公差 ANGLES ±3° .0 ±2° .00 ±1°		料号 (P/N):	
单位 (UNIT) mm		核准 (APPD)		审核 (CID)	
原材料 (MATERIAL)		数量 (QTY)		表面处理 (FINISHED)	
表面处理 (FINISHED)		绘图 (DRN) 尹彩艳 2010/5/19		页数 (SHEET) 1/1	
				比例 (SCALE) 1:1	