

REV.	EC#	DESCRIPTION	DATE	DRAWN	CHECK	APPROVED
1.00		初版发行	2018-04-22			

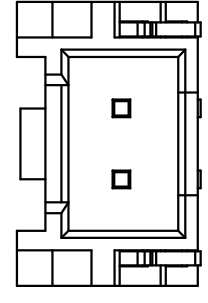

2 PIN 结构样式

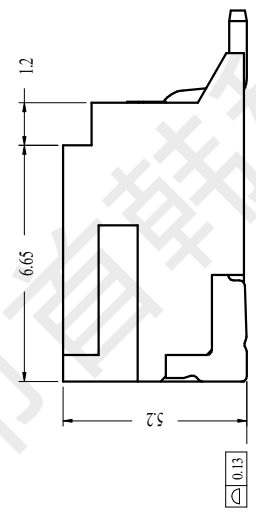
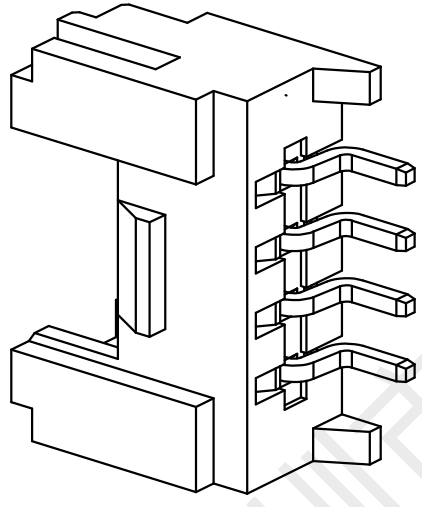
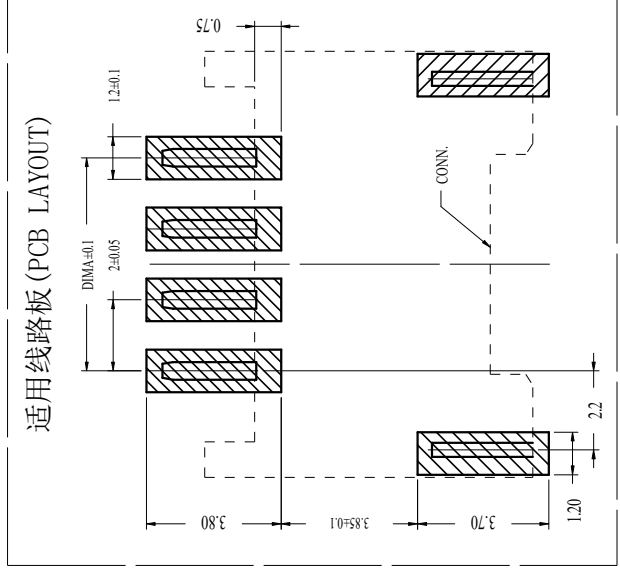
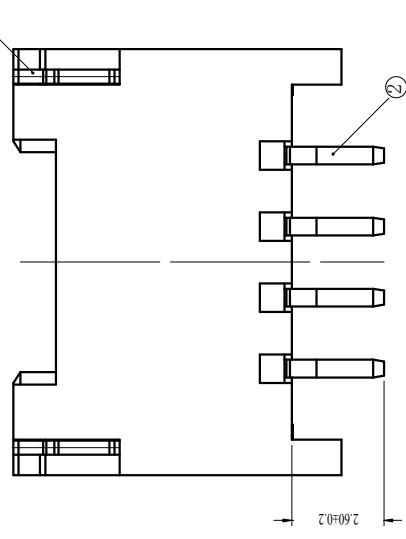
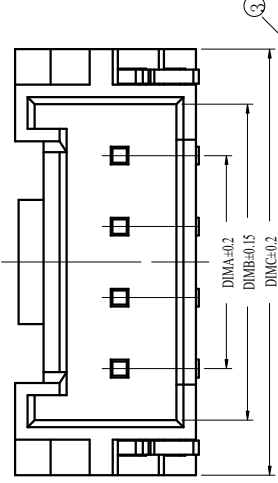
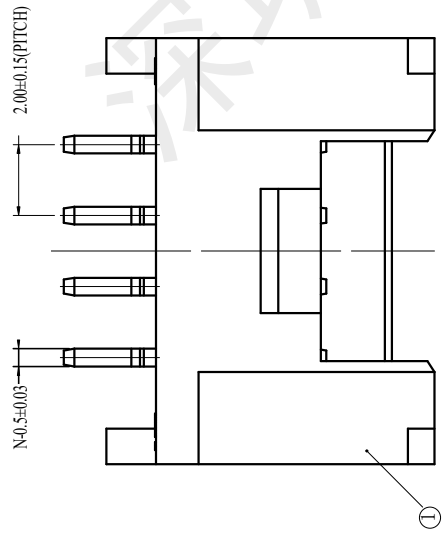

HY2.0LT	DIM.A-(mm)	DIM.B-(mm)	DIM.C-(mm)
2P	2.0mm	4.90mm	7.90mm
3P	4.0mm	6.90mm	9.90mm
4P	6.0mm	8.90mm	11.90mm
5P	8.0mm	10.90mm	13.90mm
6P	10.0mm	12.90mm	15.90mm
7P	12.0mm	14.90mm	17.90mm
8P	14.0mm	16.90mm	19.90mm
9P	16.0mm	18.90mm	21.90mm
10P	18.0mm	20.90mm	23.90mm
11P	20.0mm	22.90mm	25.90mm
12P	22.0mm	24.90mm	27.90mm
13P	24.0mm	26.90mm	29.90mm
14P	26.0mm	28.90mm	31.90mm
15P	28.0mm	30.90mm	33.90mm
16P	30.0mm	32.90mm	35.90mm

温度范围: -25°C~85°C  
 额定电压: 250V AC/DC  
 额定电流: 2A  
 绝缘电阻: ≥1000MΩ  
 耐压: 800V AC/minute

NO.	NAME	QTY	DESCRIPTION
3	FITTING NAIL	2 PCS	材质: 黄铜, 电镀: 光亮镍60μ"MIN
2	PIN	n PCS	材质: 黄铜, 电镀: 镀壳锡60μ"MIN
1	Housing	1 PCS	材质: LCP (UL94V-0), 颜色: 本色或黑色

深圳市首韩科技有限公司

DRAW :	李春风	2018-04-22	TITLE:	针座	DRAW NAME:	2.0mm-10P WTDK
DESIGN:	钟华华	2018-04-22	SERIES:	2002LT SERIES	DRAW NO.	
CHECK:	罗孝金	2018-04-22	P/N:		UNIT:	mm
APPROVED			CUSTOMER DRAWING	REV. 1.00	SCALE	N/A

GENERAL TOLERANCES		
DIM	TOL	DEG
X	X°	±3.0°
X.X	±0.15	±2.0°
X.XX	±0.25	±1.0°
X.XXX	±0.15	X.XXX°

- 技术要求:
- 1) 材质: 见附表;
  - 2) 电镀: 见附表;
  - 3) 塑件表面平整、光洁、无毛刺、气泡、烧焦、变形、浇口无拉伤、多料或缺料等不良现象;
  - 4) 端子表面无氧化、电镀不良等现象。



深圳市首韩科技有限公司

SHENZHEN SHOUHAN TECHNOLOGY CO., LTD

Tel: 0755-27597601 Fax: 0755-27597491

# 承 认 书

## SPECIFICATION FOR APPROVAL

客 户 Customer:

\_\_\_\_\_

产品名称 Project:

针座

\_\_\_\_\_

规格型号 Part No:

2.0mm-10P WTDK

\_\_\_\_\_

### 贵公司承认印 Approval signatures

料 号/Part No.	签 章/Signatures

日期 Date:

拟制/Drawn	李春风	
审核/Check	钟华华	
批准/Approved	罗孝金	

## 1、SCOPE: (适用范围)

1.1 This specification covers production and inspection of Connector.

本规范内容适用于本公司普通系列型条形连接器（针座）产品的生产与检验。

## 2、USE CONDITION: (使用条件)

2.1 Ambient temperature Range:-25℃~+85℃

环境温度：-25℃~+85℃

2.2 Applicable PC board thickness:1.2~1.6mm

适用 PC 板厚度：1.2~1.6 mm

## 3、Appearance and Dimension: (外观及尺寸)

3.1 Appearance:Product surface without defect、dirt、crack、and mechanical damang, Contact without rust,plating not oxided and not peeled.

产品表面不应有对制品有害的缺陷、污垢、裂痕及机械损伤；接触件无锈蚀、镀层氧化、脱落等现象。

3.2 Dimension:According to drawings

外形尺寸：依照附图

3.3 Exchangable:Exchangable with same specification products.

互换性：相同规格应能互换

## 4、Material:

材 料 （以图纸为准）

P/N 零件名称	Type 类 型	Material 材 料	Finish 表面处理	Explain 说 明
Terminal 端子	Contact 插 簧	Phosphor bronze 锡青磷铜 厚 0.15mm	Tin Plating:3~4 μ m 镀锡：3~4 μ m	RoHS Comp liant
Housing 孔 座	Plastic 塑 壳	Nylon66 UL94V-0	Color:White 颜色：白色	
OpeningWafer 开口针座	Contact 插 针	Phosphor bronze 锡青磷铜 厚 0.30mm	Tin Plating:3~4 μ m 镀锡：3~4 μ m	
	Plastic 塑 壳	Nylon46 UL94V-0	Color: Beige 颜色：米色	
Lips Wafer 闭口针座	Contact 插 针	Phosphor bronze 锡青磷铜 厚 0.30mm	Gold Plating:3~4 μ " m 镀金：3~4 μ " m	
	Plastic 塑 壳	PBT UL94V-0	Color: White 颜色：白色	
Tiepian Wafer 卧贴针座 立贴针座	Contact 插 针	Phosphor bronze 锡青磷铜 厚 0.30mm	Tin Plating:3~4 μ m 镀锡：3~4 μ m	
	Solder tabs 焊护耳	Phosphor bronze 锡青磷铜 厚 0.25mm	Tin Plating:3~4 μ m 镀锡：3~4 μ m	
	Plastic 塑 壳	Nylon46 UL94V-0	Color: Beige 颜色：米色	

## 5、Electrical Performance:

电气性能

NO. 序号	Item 项目	Requirement 技术要求
5.1	Voltage Rated 额定电压	250V AC DC
5.2	Current Rated 额定电流	2A AC DC
5.3	Contact Resistance 接触电阻	$\leq 20 \text{ m}\Omega$
5.4	Insulation Resistance 绝缘电阻	$\geq 1000 \text{ M}\Omega$
5.5	Dielectric Strength 耐压	$\geq 800 \text{ V AC/minute}$

## 6、Mechanical Performance:

机械性能

NO. 序号	Item 项目	Requirement 技术要求
6.1	Male contact Retention force PIN 针固定力	$\geq 10 \text{ N}$ per pin
6.2	Female contact Retention force 端子固定力	$\geq 10 \text{ N}$ per pin
6.3	Plug-in force 插入力	$\leq 3 \text{ N}$ per pin
6.4	Plug-out force 拔出力	$\geq 0.5 \text{ N}$ per pin

## 7、Endurance Characteristics:

环境性能

NO. 序号	Item 项目	Requirement 技术要求
7.1	Soldering rest 可焊性	Time: $2.5 \pm 0.5 \text{ S}$ 时间: $2.5 \pm 0.5 \text{ S}$ Temperature: $260 \pm 5^\circ \text{C}$ 温度: $260 \pm 5^\circ \text{C}$ Area of Soldering: $\geq 95\%$ 焊锡面积: $\geq 95\%$
7.2	Resistance to soldering Heat 耐焊接热	Time: $5 \pm 1 \text{ S}$ 时间: $5 \pm 1 \text{ S}$ Temperature: $260 \pm 5^\circ \text{C}$ 温度: $260 \pm 5^\circ \text{C}$ Appearance: NO Damage 外观: 无损坏

7.3	<b>Heat test</b> 耐热性	Time:96h 时间: 96 小时 Temperature:+85±3℃ 温度: +85±3℃ Appearance:NO Damage 外观: 无损坏 Contact resistance: ≤20 mΩ 接触电阻: ≤20 mΩ
7.4	<b>Cold test</b> 耐冷性	Time:48h 时间: 48 小时 Temperature:-25±3℃ 温度: -25±3℃ Appearance:NO Damage 外观: 无损坏 Contact resistance: ≤20 mΩ 接触电阻: ≤20 mΩ
7.5	<b>Temperature Cycling</b> 温度循环	Low temperature:-25±3℃ 低温: -25±3℃ High temperature:-85±3℃ 高温: -85±3℃ For 5 cycles.test after keeping in Normal Condition for 30 min. 5 次循环后, 放置在正常环境中 30 分钟, 在进行测试 Appearance: NO Damage 外观: 无损坏 Contact resistance: ≤20 mΩ 接触电阻: ≤20mΩ
7.6	<b>Invariab lenes humidity</b> 恒定湿热	Temperature:60±2℃ 温度: 60±2℃ Relative humidity:90%-96% RH 相对湿度: 90%-96% RH Tim:96h 时间: 96 小时 Appearance:NO Damage 外观: 无损坏 Contact resistance: ≤20 mΩ 接触电阻: ≤20 mΩ Insulation Resistance: ≥100MΩ 绝缘电阻: ≥100 MΩ
7.7	<b>Salt Spray</b> 盐雾试验	Salt concentration: 5±1% 浓度: 5±1% Temperature:35±2℃ 温度: 35±2℃ Tim:16±2h 时间: 16±2 小时 After salt is removed by running wafer and A drop is removed ,it is measured. 把试验样品从试验箱顶悬挂下来, 采用浓度 (5±1) %的氯化钠溶液, 连续雾化 16 小时, 试验后用流动的蒸馏水 轻轻洗去表面沉积物, 在常温常驻湿条件下恢复 1-2 小时, 外观无损伤 Appearance:NO Damage 外观: 无损坏 Contact resistance: ≤20 mΩ 接触电阻: ≤20 mΩ