

VOLTAGE RANGE: 50 - 600V
CURRENT: 2.0 A

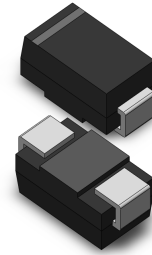

Features

- Glass Passivated Die Construction
- Ideally Suited for Automatic Assembly
- Low Forward Voltage Drop, High Efficiency
- Low Power Loss
- Super-Fast Recovery Time
- Plastic Case Material has UL Flammability Classification Rating 94V-0

Mechanical Data

- Case: SMA/DO-214AC, Molded Plastic
- Terminals: Solder Plated, Solderable per MIL-STD-750, Method 2026
- Polarity: Cathode Band or Cathode Notch
- Marking: Type Number
- Weight : 0.067 gram

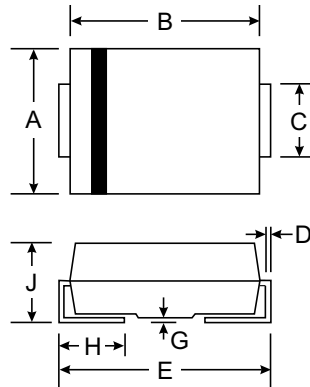

SMA(DO-214AC)		
Dim	Min	Max
A	2.29	2.92
B	4.00	4.60
C	1.27	1.63
D	0.15	0.31
E	4.80	5.59
G	0.10	0.20
H	0.76	1.52
J	2.01	2.62
All Dimensions in mm		



Maximum Ratings and Electrical Characteristics T_A = 25°C unless otherwise specified

Single phase, half wave, 60Hz, resistive or inductive load. For capacitive load, derate current by 20%.

Characteristic	Symbol	ES2AA	ES2BA	ES2CA	ES2DA	ES2EA	ES2GA	ES2JA	Unit
Peak Repetitive Reverse Voltage	V _{RRM}								
Working Peak Reverse Voltage	V _{RWM}	50	100	150	200	300	400	600	V
DC Blocking Voltage	V _R								
RMS Reverse Voltage	V _{R(RMS)}	35	70	105	140	210	280	420	V
Average Rectified Output Current @T _L = 75 °C	I _O	2.0							A
Non-Repetitive Peak Forward Surge Current 8.3ms Single half sine-wave superimposed on rated load (JEDEC Method)	I _{FSM}	50							A
Forward Voltage @I _F = 2.0A	V _{FM}	0.95				1.25		1.7	V
Peak Reverse Current @T _A = 25°C At Rated DC Blocking Voltage @T _A = 100°C	I _{RM}					5.0		200	μA
Reverse Recovery Time (Note 1)	t _{rr}					35			nS
Typical Junction Capacitance (Note 2)	C _j					62			pF
Typical Thermal Resistance (Note 3)	R _{θJL}					40			°C/W
Operating and Storage Temperature Range	T _j , T _{STG}	-65 to +150							°C

Note: 1. Measured with I_F = 0.5A, I_R = 1.0A, I_{rr} = 0.25A. See figure 5.
 2. Measured at 1.0 MHz and applied reverse voltage of 4.0 V DC.
 3. Mounted on P.C. Board with 8.0mm² land area.

RATING AND CHARACTERISTIC CURVES ES2AA THRU ES2JA

Fig. 1 - REVERSE RECOVERY TIME CHARACTERISTIC AND TEST CIRCUIT DIAGRAM ES2AA THRU ES2JA

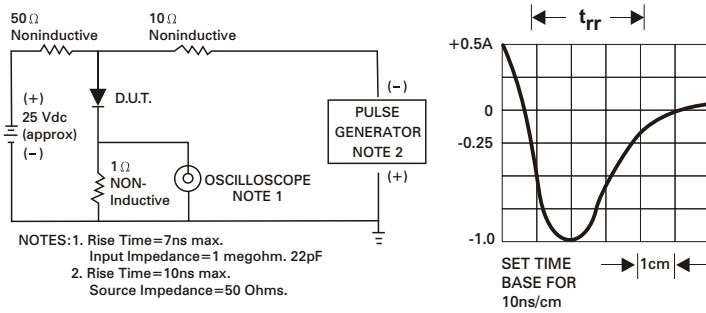

Fig. 2 - MAXIMUM AVERAGE FORWARD CURRENT RATING

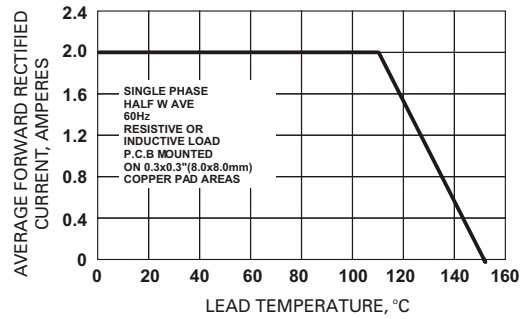

Fig. 3 - TYPICAL REVERSE CHARACTERISTICS

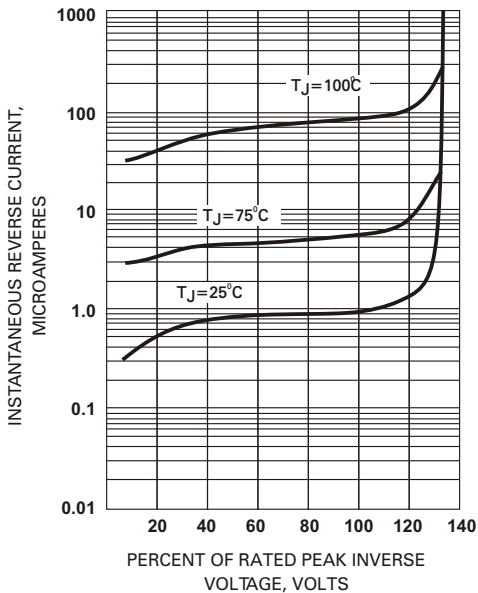

Fig. 4 - TYPICAL FORWARD CHARACTERISTICS

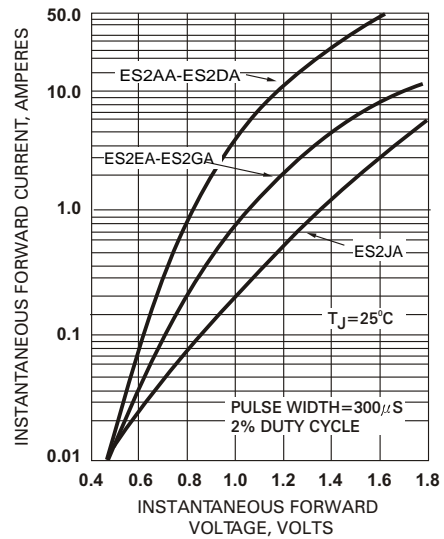

Fig. 5 - MAXIMUM NON-REPETITIVE PEAK FORWARD SURGE CURRENT

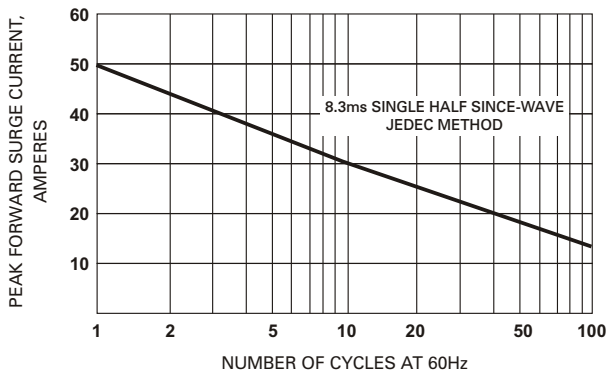

Fig. 6 - TYPICAL JUNCTION CAPACITANCE

