

Dear customer

LAPIS Semiconductor Co., Ltd. ("LAPIS Semiconductor"), on the 1st day of October, 2020, implemented the incorporation-type company split (shinsetsu-bunkatsu) in which LAPIS established a new company, LAPIS Technology Co., Ltd. ("LAPIS Technology") and LAPIS Technology succeeded LAPIS Semiconductor's LSI business.

Therefore, all references to "LAPIS Semiconductor Co., Ltd.", "LAPIS Semiconductor" and/or "LAPIS" in this document shall be replaced with "LAPIS Technology Co., Ltd."

Furthermore, there are no changes to the documents relating to our products other than the company name, the company trademark, logo, etc.

Thank you for your understanding.

LAPIS Technology Co., Ltd.
October 1, 2020

MR44V064B

64k(8,192-Word × 8-Bit) FeRAM (Ferroelectric Random Access Memory) I2C

GENERAL DESCRIPTION

The MR44V064B is a nonvolatile 8,192-word x 8-bit ferroelectric random access memory (FeRAM) developed in the ferroelectric process and silicon-gate CMOS technology. The MR44V064B is accessed using Two-wire Serial Interface (I2C BUS). Unlike SRAMs, this device, whose cells are nonvolatile, eliminates battery backup required to hold data. This device has no mechanisms of erasing and programming memory cells and blocks, such as those used for various EEPROMs. Therefore, the write cycle time can be equal to the read cycle time and the power consumption during a write can be reduced significantly.

The MR44V064B can be used in various applications, because the device is guaranteed for the write/read tolerance of 10^{12} cycles per bit and the rewrite count can be extended significantly.

FEATURES

- 8,192-word × 8-bit configuration I2C BUS Interface
- A single 3.3 V typ (1.8V to 3.6V) power supply
- Operating frequency:
 - 3.4MHz(Max) HS-mode
 - 1MHz(Max) F/S-mode Plus
- Read/write tolerance
 - 10^{12} cycles/bit
- Data retention
 - 10 years
- Guaranteed operating temperature range
 - 40 to 85°C (Extended temperature version)
- Package options:
 - 8-pin plastic SOP (P-SOP8-200-1.27-T2K)

PIN CONFIGURATION

8-pin plastic SOP

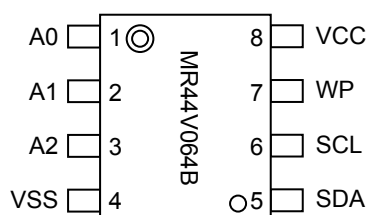
**PIN DESCRIPTIONS**

Pin Name	Description
A0 – A2	Address (input) Address pin indicates device address. When Address value is match the device address code from SDA, the device will be selected. The address pins are pulled down internally.
SDA	Serial data input serial data output (input / output) SDA is a bi-directional line for I2C interface. The output driver is open-drain. A pull-up resistor is required.
SCL	Serial Clock (input) Serial Clock is the clock input pin for setting for serial data timing. Inputs are latched on the rising edge and outputs occur on the falling edge.
WP	Write protect (input) Write Protect pin controls write-operation to the memory. When WP is high, all address in the memory will be protected. When WP is low, all address in the memory will be written. WP pin is pulled down internally.
V _{CC} , V _{SS}	Power supply Apply the specified voltage to V _{CC} . Connect V _{SS} to ground.

I2C BUS

The MR44V064B employs a bi-directional two-wire I2C BUS interface, works as a slave device.

An example of I2C interface system with MR44V064B

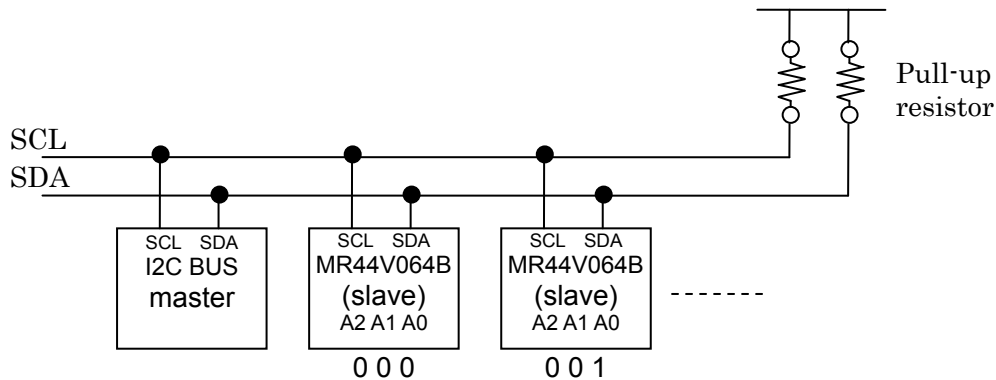

I2C BUS COMMUNICATION

I2C BUS data communication starts by start condition input, and ends by stop condition input. Data is always 8bit long, acknowledge is always required after each byte. I2C BUS carries out data transmission with plural devices connected by 2 communication lines of serial data (SDA) and serial clock (SCL).

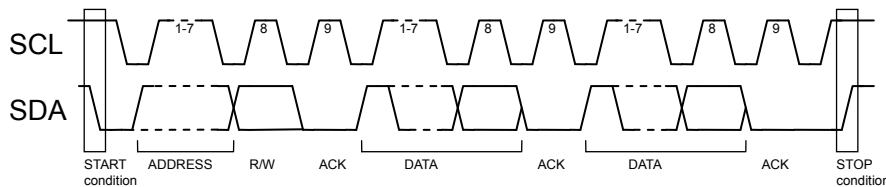

START CONDITION

Before executing each command, start condition (start bit) where SDA goes from “HIGH” down to “LOW” when SCL is “HIGH” is necessary. MR44V064B always detects whether SDA and SCL are in start condition (start bit) or not, therefore, unless this condition is satisfied, any command is executed.

STOP CONDITION

Each command can be ended by SDA rising from “LOW” to “HIGH” when stop condition (stop bit), namely,SCL is “HIGH”.

ACKNOWLEDGE (ACK) SIGNAL

This acknowledge (ACK) signal is a software rule to show whether data transfer has been made normally or not. In master and slave, the device (μ-COM at slave address input of write command, read command, and this IC at data output of read command) at the transmitter (sending) side releases the bus after output of 8bit data.

The device (this IC at slave address input of write command, read command, and μ-COM at data output of read command) at the receiver (receiving) side sets SDA “LOW” during 9 clock cycles, and outputs acknowledge signal (ACK signal) showing that it has received the 8bit data.

This IC, after recognizing start condition and slave address (8bit), outputs acknowledge signal (ACK signal) “LOW”.

Each write action outputs acknowledge signal (ACK signal) “LOW”, at receiving 8bit data (word address and write data).

Each read action outputs 8bit data (read data), and detects acknowledge signal (ACK signal) “LOW”.

When acknowledge signal (ACK signal) is detect, and stop condition is not sent from the master (μ-COM) side, this IC continues data output. When acknowledge signal (ACK signal) is not detected, this IC stops data transfer, and recognizes stop condition (stop bit), and ends read action. And this IC gets in status.

SLAVE ADDRESS

Output slave address after start condition from master.

The significant 4 bits of slave address are used for recognizing a device type. The device code of this IC is fixed to “1010”.

Next slave addresses (A2 A1 A0 ... device address) are for selecting devices, and plural ones can be used on a same bus according to the number of device addresses.

The most insignificant bit (R/W...READ/WRITE) of slave address is used for designating write or read action, and is as shown below.

Setting R/W to 0	write (setting 0 to word address setting of random read)
Setting R/W to 1	read

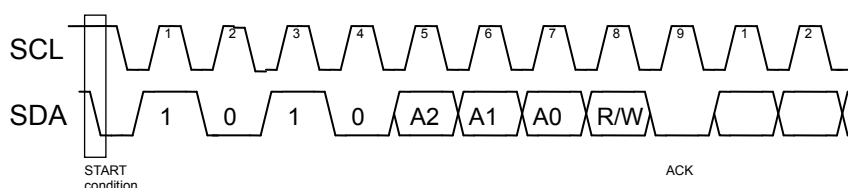

WRITE PROTECT

When WP terminal is set Vcc(H level), data rewrite of all addresses is prohibited. When it is set Vss(L level), data rewrite of all address is enabled. Be sure to connect this terminal to Vcc or Vss, or control it to H level or L level.

At extremely low voltage at power ON / OFF, by setting the WP terminal “H”, mistake write can be prevented.

COMMAND

BYTE WRITE CYCLE

Arbitrary data is written to FeRAM. When to write only 1 byte, byte write is normally used.

- start condition
- slave address with LSB is 0 (write)
- 1st and 2nd word address
- byte of write data.
- stop condition

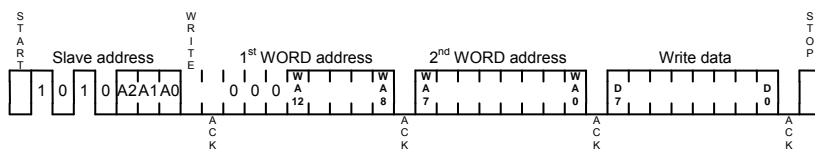

PAGE WRITE CYCLE

When to write continuous data of 2 bytes or more, simultaneous write is possible by page write cycle. By page write cycle, up to 8,192 bytes data can be written. When data of the maximum bytes or higher is sent, data from the first byte is overwritten.

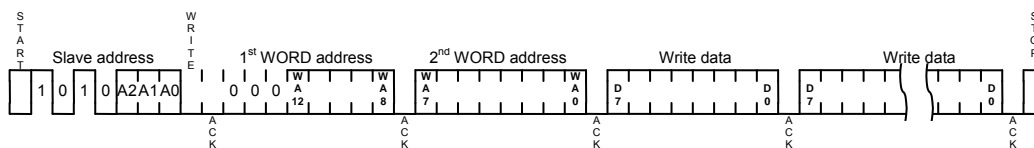

BYTE WRITE CYCLE (HS-MODE)



RANDOM READ CYCLE

Random read cycle is a command to read data by designating address.

- start condition
- slave address with LSB is 0 (write)
- 1st and 2nd word address
- start condition
- slave address with LSB is 1 (read)
- read out byte of data.
- ACK to “H”
- stop condition

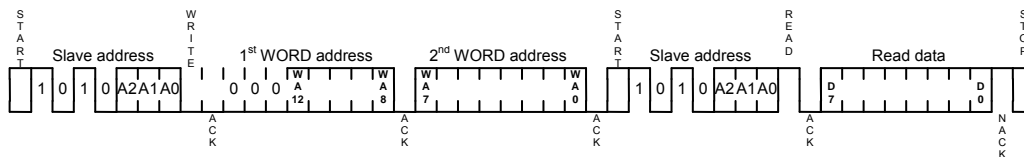

SEQUENTIAL READ CYCLE

When ACK signal “L” after D0 is detected, and stop condition is not sent from master side, the next address data can be read in succession.

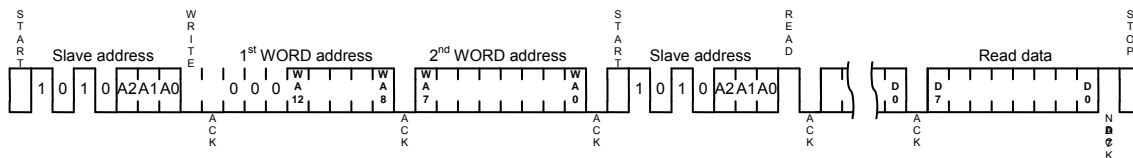

CURRENT ADDRESS READ CYCLE

Current address read cycle is a command to read data of internal address register without designating address. When the last read or write address is (n)-th address just before current read cycle, the current address read command outputs data of (n+1)-th address. The previous read or write sequence should be complete up to stop condition.

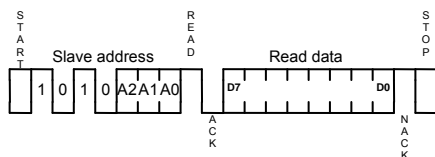

CURRENT ADDRESS READ CYCLE (HS-MODE)

The MR44V064B support a 3.4MHz high speed mode. When HS-mode operation is needed, the HS-mode command is required before any command. After the HS-mode command is issued, MR44V064B will be the HS-mode, until stop condition is issued.



ELECTRICAL CHARACTERISTICS**ABSOLUTE MAXIMUM RATINGS**

The application of stress (voltage, current, or temperature) that exceeds the absolute maximum rating may damage the device. Therefore, do not allow actual characteristics to exceed any one parameter ratings

PIN VOLTAGES

Parameter	Symbol	Rating		Unit	Note
		Min.	Max.		
Pin Voltage (Input Signal)	V_{IN}	-0.5	$V_{CC} + 0.5$	V	
Pin Voltage (Input/Output Voltage)	V_{INQ}, V_{OUTQ}	-0.5	$V_{CC} + 0.5$	V	
Power Supply Voltage	V_{CC}	-0.5	4.0	V	

TEMPERATURE RANGE

Parameter	Symbol	Rating		Unit	Note
		Min.	Max.		
Storage Temperature (Extended Temperature Version)	T_{stg}	-55	125	°C	
Operating Temperature (Extended Temperature Version)	T_{opr}	-40	85	°C	

OTHERS

Parameter	Symbol	Rating	Note
Power Dissipation	P_D	1,000mW	$T_a=25^{\circ}\text{C}$

RECOMMENDED OPERATING CONDITIONS**POWER SUPPLY VOLTAGE**

Parameter	Symbol	Min.	Typ.	Max.	Unit	Note
Power Supply Voltage	V_{CC}	1.8	3.3	3.6	V	
Ground Voltage	V_{SS}	0	0	0	V	

DC INPUT VOLTAGE

Parameter	Symbol	Min.	Max.	Unit	Note
Input High Voltage	V_{IH}	$V_{CC} \times 0.7$	$V_{CC} + 0.3$	V	
Input Low Voltage	V_{IL}	-0.3	$V_{CC} \times 0.3$	V	

DC CHARACTERISTICS**DC INPUT/OUTPUT CHARACTERISTICS**

Parameter	Symbol	Condition	Min.	Max.	Unit	Note
Output Low Voltage	V_{OL}	$I_{OL} = 3\text{mA}$	—	0.4	V	
Input Leakage Current	I_{LI}	—	-10	10	μA	
Output Leakage Current	I_{LO}	—	-10	10	μA	

POWER SUPPLY CURRENT $V_{CC} = \text{Max. to Min.}, T_a = T_{opr}$

Parameter	Symbol	Condition	Max.	Unit	Note
Power Supply Current (Standby)	I_{CCS}	SCL, SDA = V_{CC} , A2, A1, A0 = V_{CC} or V_{SS}	10	μA	
Power Supply Current (Operating)	I_{CCA}	$V_{IN} = 0.3\text{V}$ or $V_{CC} - 0.3\text{V}$, fSCL = 3.4MHz fSCL = 1MHz	1 300	mA μA	

AC CHARACTERISTICS

 V_{CC} =Max. to Min., T_a =Topr.

Parameter	Symbol	F/S-mode		F/S-mode Plus		HS-mode		Unit	Note
		Min.	Max.	Min.	Max.	Min.	Max.		
Clock frequency	f_{SCL}	D.C.	400	D.C.	1000	DC	3400	KHz	
Clock Low time	t_{LOW}	1300		500		160		ns	
Clock High time	t_{HIGH}	600		300		60		ns	
Output Data delay time	t_{AA}		900		450		130	ns	
BUS release time before transfer start	t_{BUF}	1300		500		300		ns	
Start condition hold time	$t_{HD:STA}$	600		250		160		ns	
Start condition setup time	$t_{SU:STA}$	600		250		160		ns	
Input data hold time	$t_{HD:DAT}$	0		0		0		ns	
Input data setup time	$t_{SU:DAT}$	100		100		10		ns	
SDA, SCL rise time	t_R		300		300		80	ns	1
SDA, SCL fall time	t_F		300		100		80	ns	1
Stop condition setup time	$t_{SU:STO}$	600		250		160		ns	
Output data hold time	t_{DH}	0		0		0		ns	
Noise removal time (SDA, SCL)	t_{SP}		50		50		5	ns	

Note: 1. Not 100% tested

Equivalent AC Load Circuit

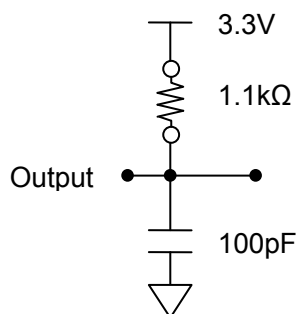

TIMING

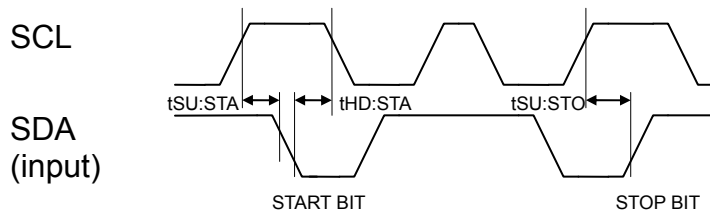
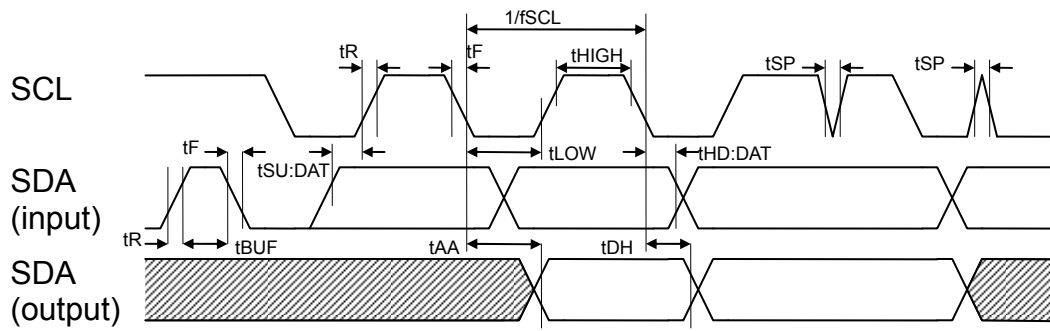

•POWER-ON AND POWER-OFF CHARACTERISTICS

(Under recommended operating conditions)

Parameter	Symbol	Min.	Max.	Unit	Note
Power-On SCL,SDA High Hold Time	t_{VHEL}	100	—	ns	1, 2
Power-Off SCL, SDA High Hold Time	t_{EHVL}	0	—	ns	1
Power-On Interval Time	t_{VLVH}	0	—	μ s	2
V_{CC} Power-On ramp rate	t_r	30		μ s/V	
V_{CC} Power-Off ramp rate	t_f	30		μ s/V	

Notes:

1. To prevent an erroneous operation, be sure to maintain SCL=SDA="H", and set the FeRAM in an inactive state (standby mode) before and after power-on and power-off.
2. Powering on at the intermediate voltage level will cause an erroneous operation; thus, be sure to power up from 0 V.
3. Enter all signals at the same time as power-on or enter all signals after power-on.

•Power-On and Power-Off Sequences

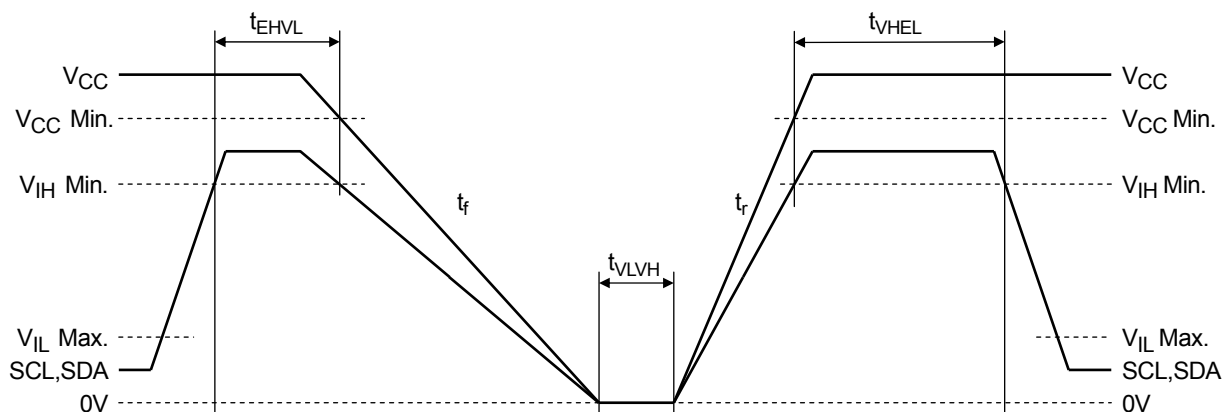

READ/WRITE CYCLES AND DATA RETENTION

(Under recommended operating conditions)

Parameter	Min.	Max.	Unit	Note
Read/Write Cycle	10 ¹²	—	Cycle	
Data Retention	10	—	Year	

CAPACITANCE

Signal	Symbol	Min.	Max.	Unit	Note
Input Capacitance	C _{IN}	—	10	pF	1
Input/Output Capacitance	C _{OUT}	—	10	pF	1

Note1:

Sampling value. Measurement conditions are V_{IN} = V_{OUT} = GND, f = 1MHz, and Ta = 25°C

PACKAGE DIMENSIONS

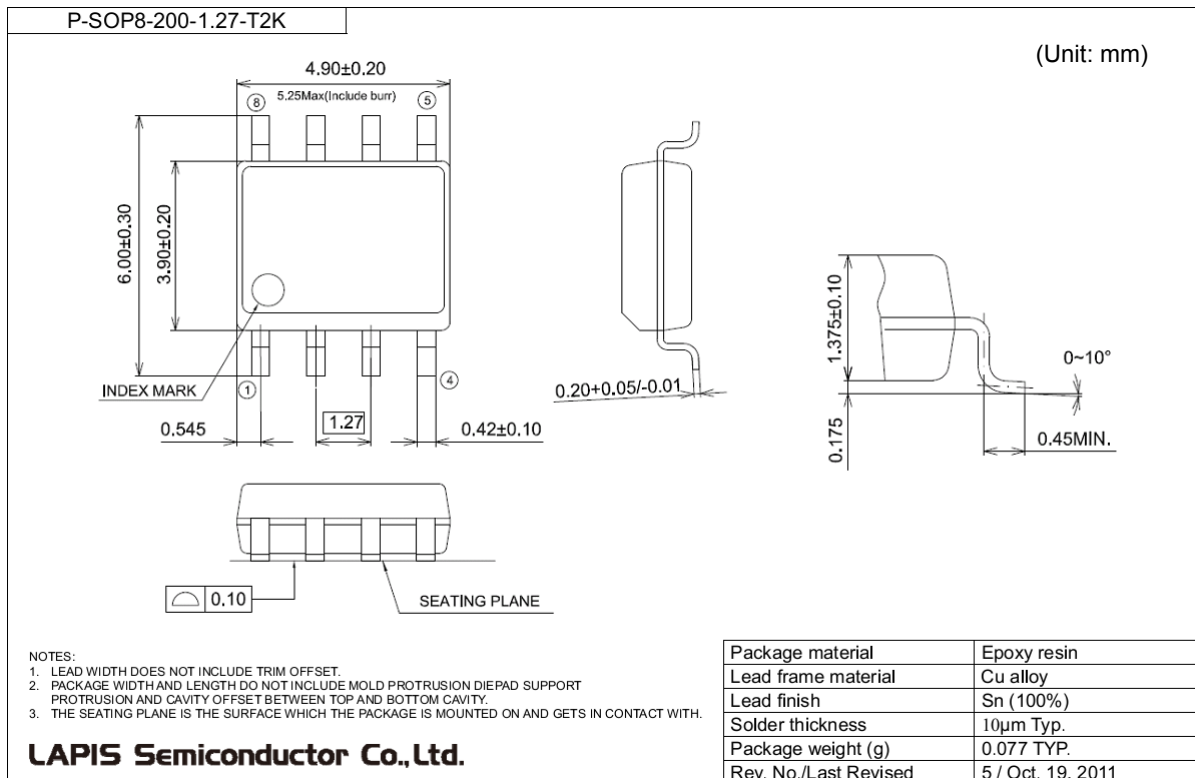

Notes for Mounting the Surface Mount Type Package

The surface mount type packages are very susceptible to heat in reflow mounting and humidity absorbed in storage. Therefore, before you perform reflow mounting, contact a ROHM sales office for the product name, package name, pin number, package code and desired mounting conditions (reflow method, temperature and times).

REVISION HISTORY

Document No.	Date	Page		Description
		Previous Edition	Current Edition	
FEDR44V064B-01	Jan. 08, 2016	–	–	Final edition 1

Notes

- 1) The information contained herein is subject to change without notice.
- 2) Although LAPIS Semiconductor is continuously working to improve product reliability and quality, semiconductors can break down and malfunction due to various factors. Therefore, in order to prevent personal injury or fire arising from failure, please take safety measures such as complying with the derating characteristics, implementing redundant and fire prevention designs, and utilizing backups and fail-safe procedures. LAPIS Semiconductor shall have no responsibility for any damages arising out of the use of our Products beyond the rating specified by LAPIS Semiconductor.
- 3) Examples of application circuits, circuit constants and any other information contained herein are provided only to illustrate the standard usage and operations of the Products. The peripheral conditions must be taken into account when designing circuits for mass production.
- 4) The technical information specified herein is intended only to show the typical functions of the Products and examples of application circuits for the Products. No license, expressly or implied, is granted hereby under any intellectual property rights or other rights of LAPIS Semiconductor or any third party with respect to the information contained in this document; therefore LAPIS Semiconductor shall have no responsibility whatsoever for any dispute, concerning such rights owned by third parties, arising out of the use of such technical information.
- 5) The Products are intended for use in general electronic equipment (i.e. AV/OA devices, communication, consumer systems, gaming/entertainment sets) as well as the applications indicated in this document.
- 6) The Products specified in this document are not designed to be radiation tolerant.
- 7) For use of our Products in applications requiring a high degree of reliability (as exemplified below), please contact and consult with a LAPIS Semiconductor representative: transportation equipment (i.e. cars, ships, trains), primary communication equipment, traffic lights, fire/crime prevention, safety equipment, medical systems, servers, solar cells, and power transmission systems.
- 8) Do not use our Products in applications requiring extremely high reliability, such as aerospace equipment, nuclear power control systems, and submarine repeaters.
- 9) LAPIS Semiconductor shall have no responsibility for any damages or injury arising from non-compliance with the recommended usage conditions and specifications contained herein.
- 10) LAPIS Semiconductor has used reasonable care to ensure the accuracy of the information contained in this document. However, LAPIS Semiconductor does not warrant that such information is error-free and LAPIS Semiconductor shall have no responsibility for any damages arising from any inaccuracy or misprint of such information.
- 11) Please use the Products in accordance with any applicable environmental laws and regulations, such as the RoHS Directive. For more details, including RoHS compatibility, please contact a ROHM sales office. LAPIS Semiconductor shall have no responsibility for any damages or losses resulting non-compliance with any applicable laws or regulations.
- 12) When providing our Products and technologies contained in this document to other countries, you must abide by the procedures and provisions stipulated in all applicable export laws and regulations, including without limitation the US Export Administration Regulations and the Foreign Exchange and Foreign Trade Act.
- 13) This document, in part or in whole, may not be reprinted or reproduced without prior consent of LAPIS Semiconductor.

Copyright 2016 LAPIS Semiconductor Co., Ltd.

LAPIS Semiconductor Co.,Ltd.

2-4-8 Shinyokohama, Kouhoku-ku,
Yokohama 222-8575, Japan
<http://www.lapis-semi.com/en/>