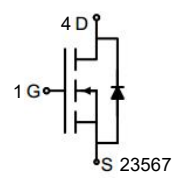
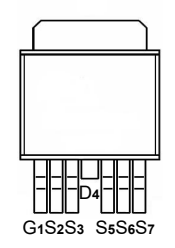
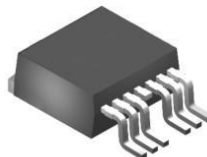

N-Channel Enhancement Mode Power MOSFET

<p>Description</p> <p>The GT025N06AM6 uses advanced trench technology to provide excellent $R_{DS(ON)}$, low gate charge. It can be used in a wide variety of applications.</p> <p>General Features</p> <ul style="list-style-type: none"> ● V_{DS} 60V ● I_D (at $V_{GS} = 10V$) 170A ● $R_{DS(ON)}$ (at $V_{GS} = 10V$) < 2mΩ ● $R_{DS(ON)}$ (at $V_{GS} = 4.5V$) < 2.5mΩ ● 100% Avalanche Tested ● RoHS Compliant <p>Application</p> <ul style="list-style-type: none"> ● Power switch ● DC/DC converters 	<div style="text-align: center;">  <p>Schematic diagram</p>  <p>pin assignment</p>  <p>TO-263-6</p> </div>
---	---

Ordering Information

Device	Package	Marking	Packaging
GT025N06AM6	TO-263-6L	GT025N06	800psc/Reel

Absolute Maximum Ratings $T_C = 25^\circ C$, unless otherwise noted

Parameter	Symbol	Value	Unit
Drain-Source Voltage	V_{DS}	60	V
Continuous Drain Current	I_D	170	A
Pulsed Drain Current (note1)	I_{DM}	300	A
Gate-Source Voltage	V_{GS}	± 20	V
Power Dissipation	P_D	215	W
Single pulse avalanche energy (note2)	E_{AS}	324	mJ
Operating Junction and Storage Temperature Range	T_J, T_{stg}	-55 To 150	$^\circ C$

Thermal Resistance

Parameter	Symbol	Value	Unit
Thermal Resistance, Junction-to-Ambient	R_{thJA}	50	$^\circ C/W$
Maximum Junction-to-Case	R_{thJC}	0.58	$^\circ C/W$

Specifications $T_J = 25^\circ\text{C}$, unless otherwise noted						
Parameter	Symbol	Test Conditions	Value			Unit
			Min.	Typ.	Max.	
Static Parameters						
Drain-Source Breakdown Voltage	$V_{(BR)DSS}$	$V_{GS} = 0V, I_D = 250\mu A$	60	--	--	V
Zero Gate Voltage Drain Current	I_{DSS}	$V_{DS} = 60V, V_{GS} = 0V$	--	--	1	μA
Gate-Source Leakage	I_{GSS}	$V_{GS} = \pm 20V$	--	--	± 100	nA
Gate-Source Threshold Voltage	$V_{GS(th)}$	$V_{DS} = V_{GS}, I_D = 250\mu A$	1.2	1.6	2.5	V
Drain-Source On-Resistance	$R_{DS(on)}$	$V_{GS} = 10V, I_D = 20A$	--	1.6	2	m Ω
		$V_{GS} = 4.5V, I_D = 15A$	--	2.1	2.5	
Forward Transconductance	g_{FS}	$V_{GS} = 5V, I_D = 20A$	--	66	--	S
Dynamic Parameters						
Input Capacitance	C_{iss}	$V_{GS} = 0V,$ $V_{DS} = 30V,$ $f = 1.0\text{MHz}$	--	5058	--	pF
Output Capacitance	C_{oss}		--	1402	--	
Reverse Transfer Capacitance	C_{rss}		--	71	--	
Total Gate Charge	Q_g	$V_{DD} = 30V,$ $I_D = 50A,$ $V_{GS} = 10V$	--	70	--	nC
Gate-Source Charge	Q_{gs}		--	21	--	
Gate-Drain Charge	Q_{gd}		--	16	--	
Turn-on Delay Time	$t_{d(on)}$	$V_{DD} = 30V,$ $I_D = 50A,$ $R_G = 3\Omega$	--	16	--	ns
Turn-on Rise Time	t_r		--	9	--	
Turn-off Delay Time	$t_{d(off)}$		--	36	--	
Turn-off Fall Time	t_f		--	11	--	
Drain-Source Body Diode Characteristics						
Continuous Body Diode Current	I_S	$T_C = 25^\circ\text{C}$	--	--	170	A
Body Diode Voltage	V_{SD}	$T_J = 25^\circ\text{C}, I_{SD} = 20A, V_{GS} = 0V$	--	--	1.2	V
Reverse Recovery Charge	Q_{rr}	$I_F = 20A, V_{GS} = 0V$ $di/dt = 500A/\mu s$	--	150	--	nC
Reverse Recovery Time	T_{rr}		--	30	--	ns

Notes

1. Repetitive Rating: Pulse width limited by maximum junction temperature
2. EAS condition : $T_J = 25^\circ\text{C}, V_{DD} = 50V, V_{GS} = 10V, L = 0.5\text{mH}, R_g = 25\Omega$

Gate Charge Test Circuit

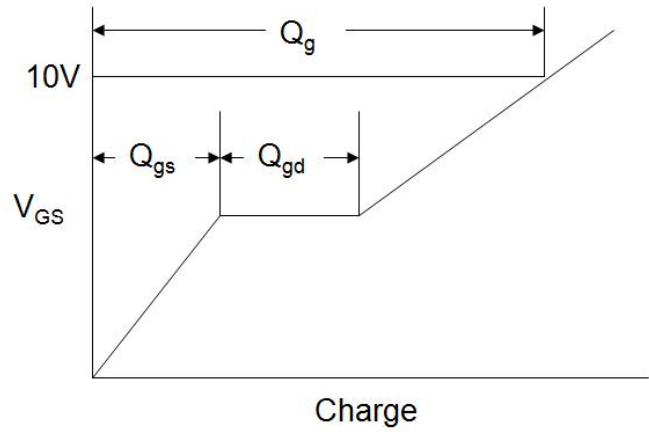
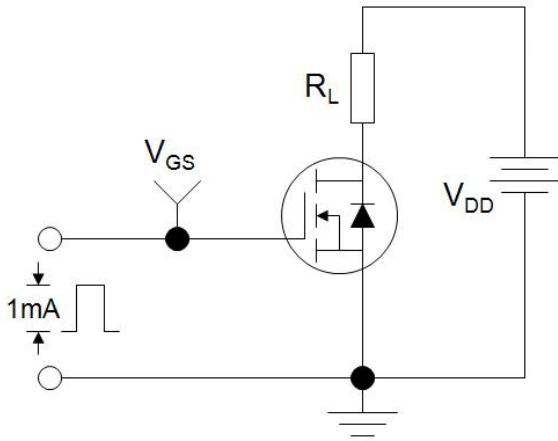

Switch Time Test Circuit



EAS Test Circuit



Typical Characteristics $T_J = 25^\circ\text{C}$, unless otherwise noted

Figure 1. Output Characteristics

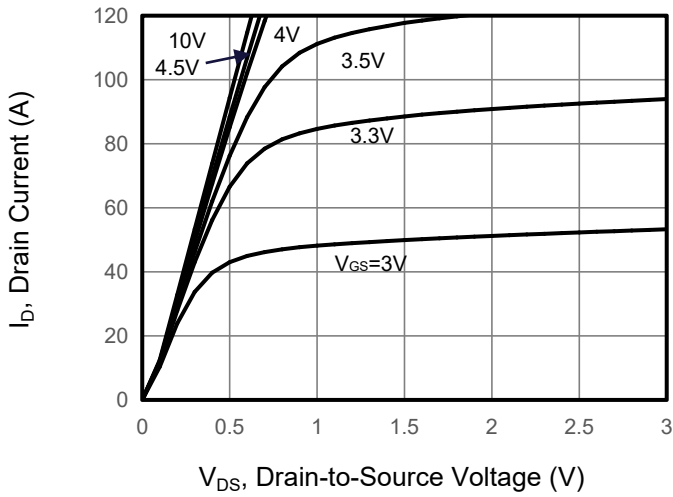

Figure 2. Transfer Characteristics

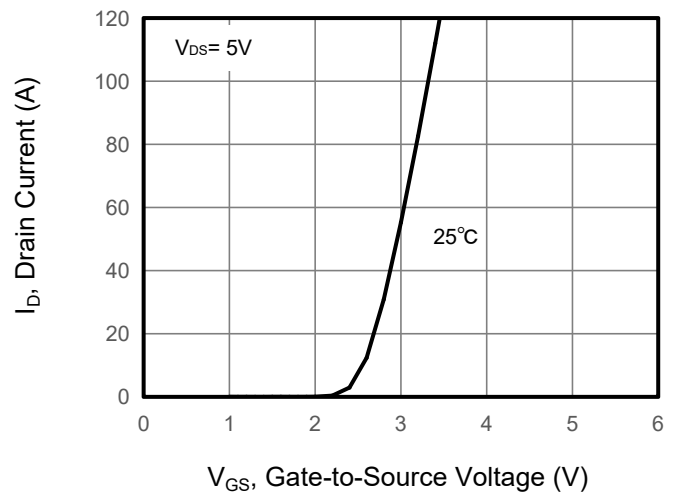

Figure 3. Drain Source On Resistance

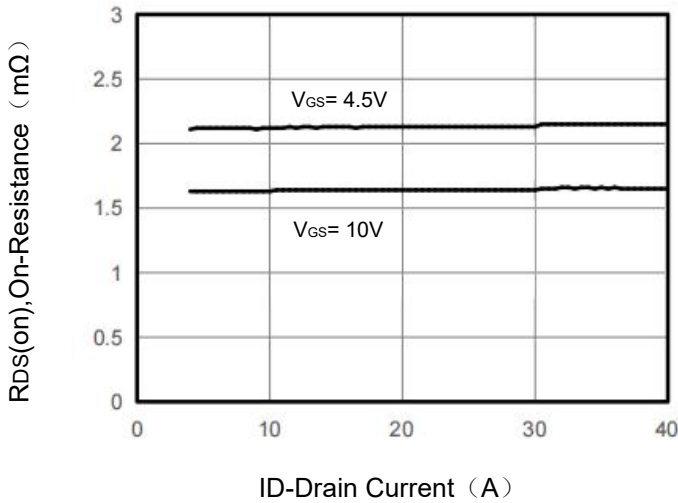

Figure 4. Gate Charge

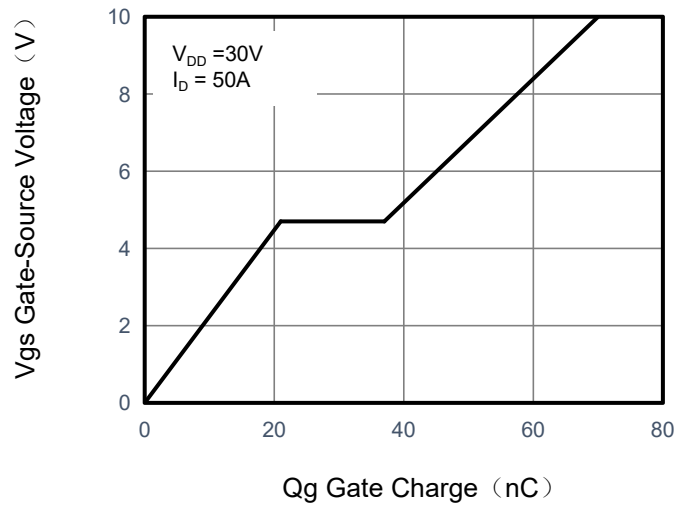

Figure 5. Capacitance

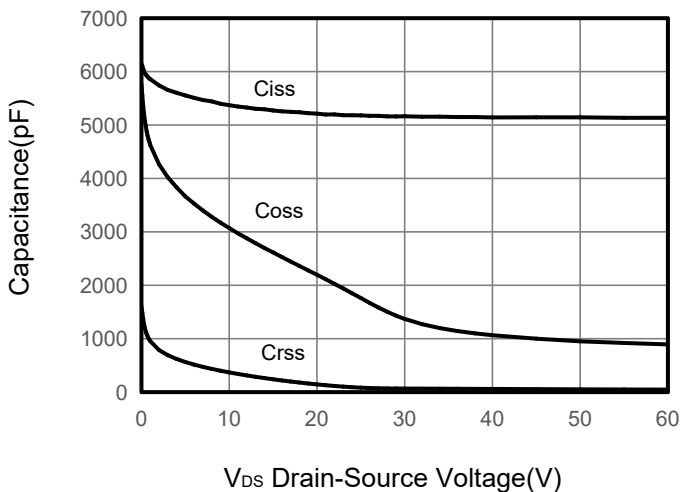
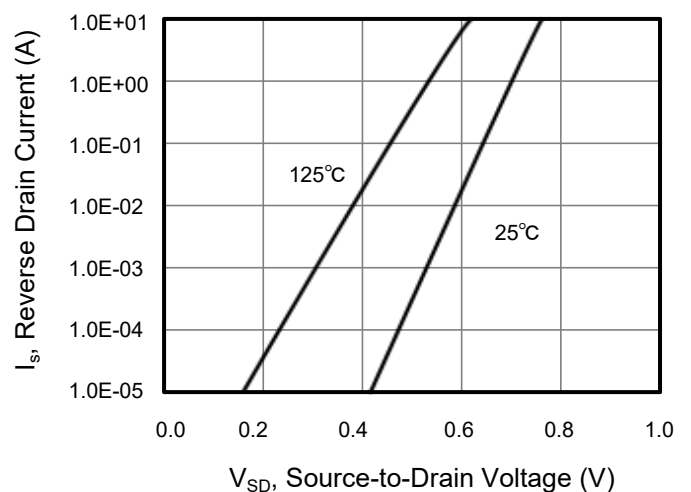

Figure 6. Source-Drain Diode Forward



Typical Characteristics $T_J = 25^\circ\text{C}$, unless otherwise noted

Figure 7. Drain-Source On-Resistance

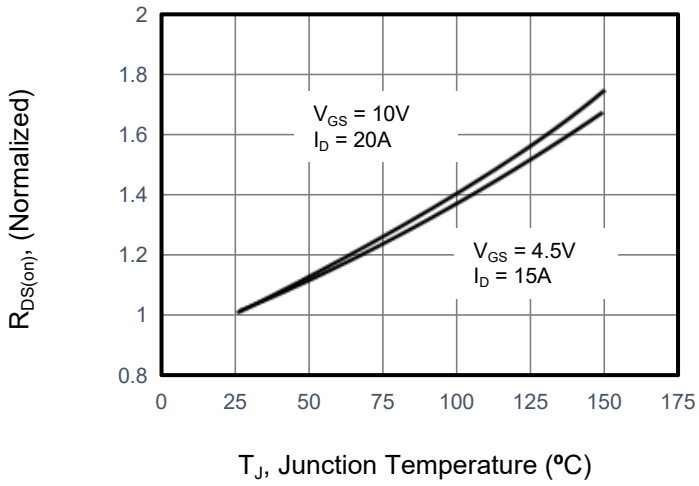

Figure 8. Safe Operation Area

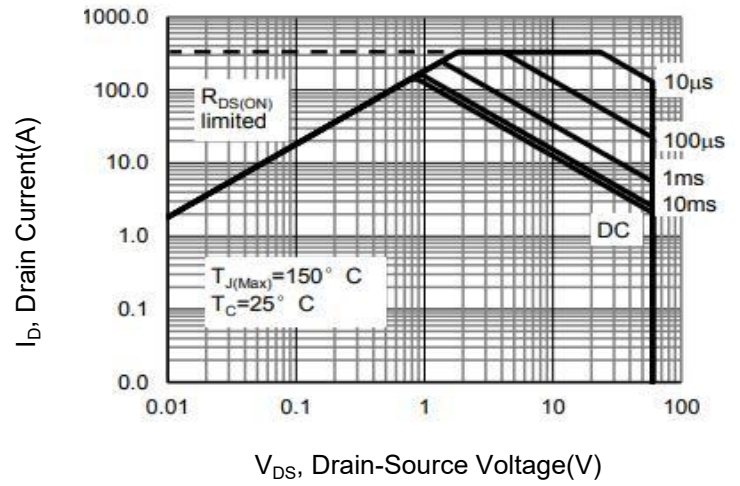
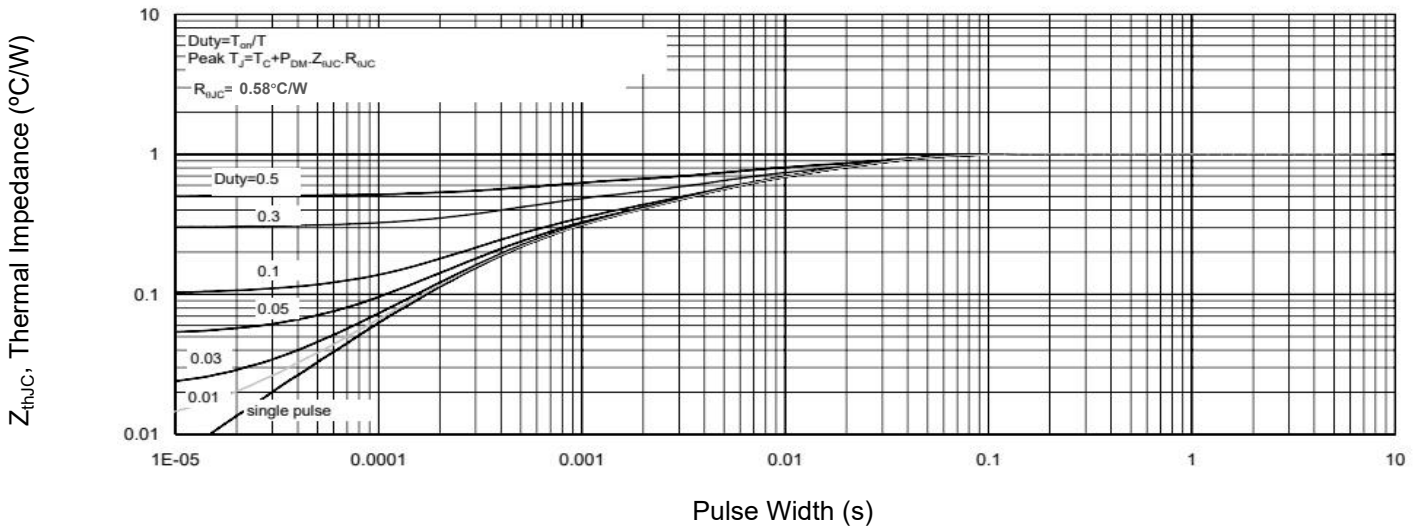
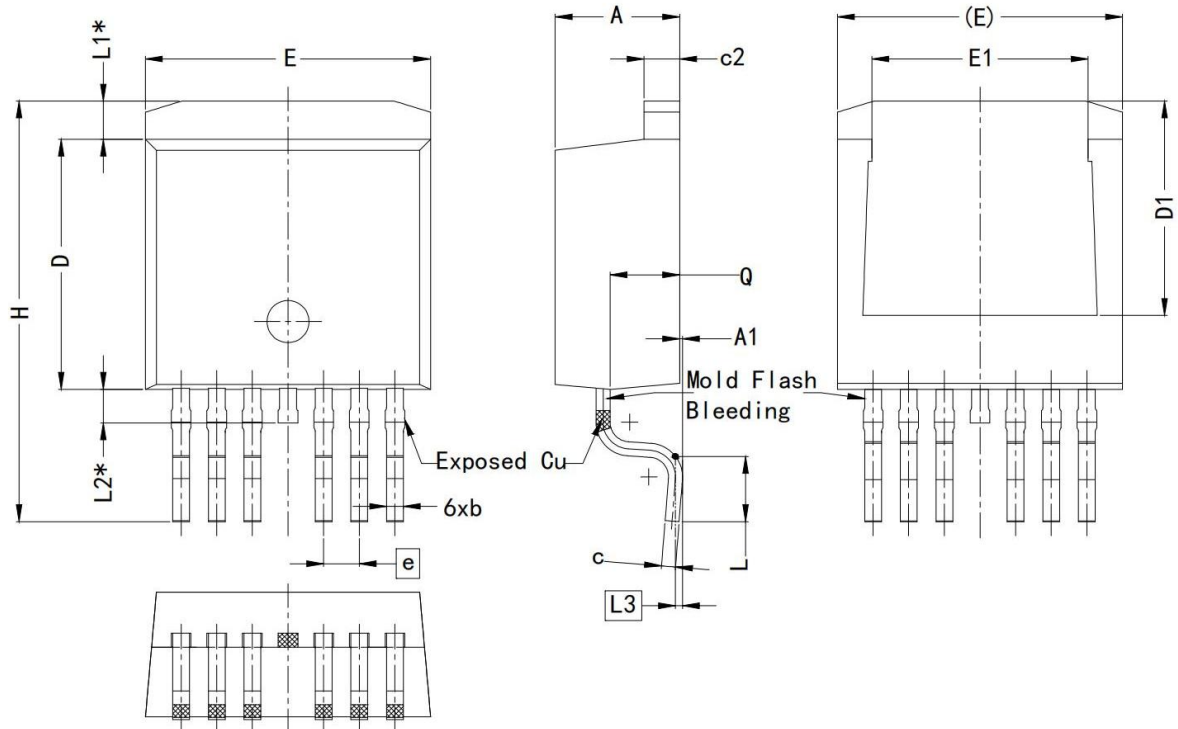

Figure 9. Normalized Maximum Transient Thermal Impedance



TO-263-6L Package Information



SYMBOL	DIMENSIONS		
	MIN.	NOM.	MAX.
A	4.24	4.44	4.64
A1	0.00	0.10	0.25
b	0.50	0.60	0.70
c	0.40	0.50	0.60
c2	1.15	1.27	1.40
D	8.82	8.92	9.02
D1	6.86	7.65	---
E	9.96	10.16	10.36
E1	6.89	7.77	7.89
e	1.27BSC		
H	14.61	15.00	15.88
L	1.78	2.32	2.79
L1	1.36REF.		
L2	1.20REF.		
L3	0.25BSC		
Q	2.30	2.48	2.70