

P-Channel Enhancement Mode Power MOSFET

Description

The G13P04S uses advanced trench technology to provide excellent $R_{DS(ON)}$, low gate charge. It can be used in a wide variety of applications.

General Features

- V_{DS} -40V
- I_D (at $V_{GS} = -10V$) -13A
- $R_{DS(ON)}$ (at $V_{GS} = -10V$) < 15m Ω
- 100% Avalanche Tested
- RoHS Compliant

Application

- Power switch
- DC/DC converters

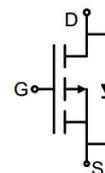

Schematic diagram

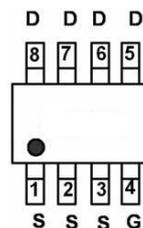

pin assignment



SOP-8

Ordering Information

Device	Package	Marking	Packaging
G13P04S	SOP-8	G13P04	4000pcs/Reel

Absolute Maximum Ratings $T_C = 25^\circ\text{C}$, unless otherwise noted

Parameter	Symbol	Value	Unit
Drain-Source Voltage	V_{DS}	-40	V
Continuous Drain Current	I_D	-13	A
Pulsed Drain Current (note1)	I_{DM}	-52	A
Gate-Source Voltage	V_{GS}	± 20	V
Power Dissipation	P_D	3	W
Operating Junction and Storage Temperature Range	T_J, T_{stg}	-55 To 150	$^\circ\text{C}$

Thermal Resistance

Parameter	Symbol	Value	Unit
Thermal Resistance, Junction-to-Ambient	R_{thJA}	40	$^\circ\text{C}/\text{W}$

Specifications $T_J = 25^\circ\text{C}$, unless otherwise noted						
Parameter	Symbol	Test Conditions	Value			Unit
			Min.	Typ.	Max.	
Static Parameters						
Drain-Source Breakdown Voltage	$V_{(BR)DSS}$	$V_{GS} = 0V, I_D = -250\mu A$	-40	--	--	V
Zero Gate Voltage Drain Current	I_{DSS}	$V_{DS} = -40V, V_{GS} = 0V$	--	--	-1	μA
Gate-Source Leakage	I_{GSS}	$V_{GS} = \pm 20V$	--	--	± 100	nA
Gate-Source Threshold Voltage	$V_{GS(th)}$	$V_{DS} = V_{GS}, I_D = -250\mu A$	-1.3	-1.8	-2.5	V
Drain-Source On-Resistance	$R_{DS(on)}$	$V_{GS} = -10V, I_D = -12A$	--	13	15	m Ω
Forward Transconductance	g_{FS}	$V_{DS} = -5V, I_D = -12A$	--	30	--	S
Dynamic Parameters						
Input Capacitance	C_{iss}	$V_{GS} = 0V,$ $V_{DS} = -20V,$ $f = 1.0\text{MHz}$	--	3271	--	pF
Output Capacitance	C_{oss}		--	324	--	
Reverse Transfer Capacitance	C_{rss}		--	247	--	
Total Gate Charge	Q_g	$V_{DD} = -20V,$ $I_D = -12A,$ $V_{GS} = -10V$	--	40	--	nC
Gate-Source Charge	Q_{gs}		--	6	--	
Gate-Drain Charge	Q_{gd}		--	12	--	
Turn-on Delay Time	$t_{d(on)}$	$V_{DD} = -20V,$ $I_D = -7A,$ $R_G = 6\Omega$	--	11	--	ns
Turn-on Rise Time	t_r		--	75	--	
Turn-off Delay Time	$t_{d(off)}$		--	89	--	
Turn-off Fall Time	t_f		--	35	--	
Drain-Source Body Diode Characteristics						
Continuous Body Diode Current	I_S	$T_C = 25^\circ\text{C}$	--	--	-13	A
Body Diode Voltage	V_{SD}	$T_J = 25^\circ\text{C}, I_{SD} = -12A, V_{GS} = 0V$	--	--	-1.2	V
Reverse Recovery Charge	Q_{rr}	$I_F = -10A, V_{GS} = 0V$ $di/dt = -100A/\mu s$	--	33	--	nC
Reverse Recovery Time	T_{rr}		--	31	--	ns

Notes

1. Repetitive Rating: Pulse width limited by maximum junction temperature
2. Identical low side and high side switch with identical R_G
3. EAS condition : $T_J = 25^\circ\text{C}, V_{DD} = -40V, V_{GS} = -10V, L = 0.5\text{mH}, R_G = 25\Omega$

Gate Charge Test Circuit

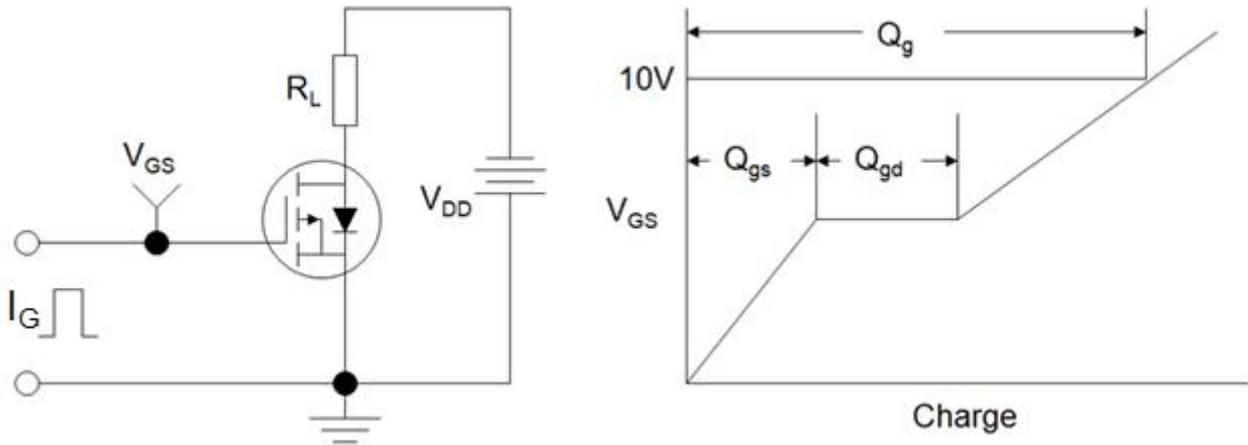

Switch Time Test Circuit

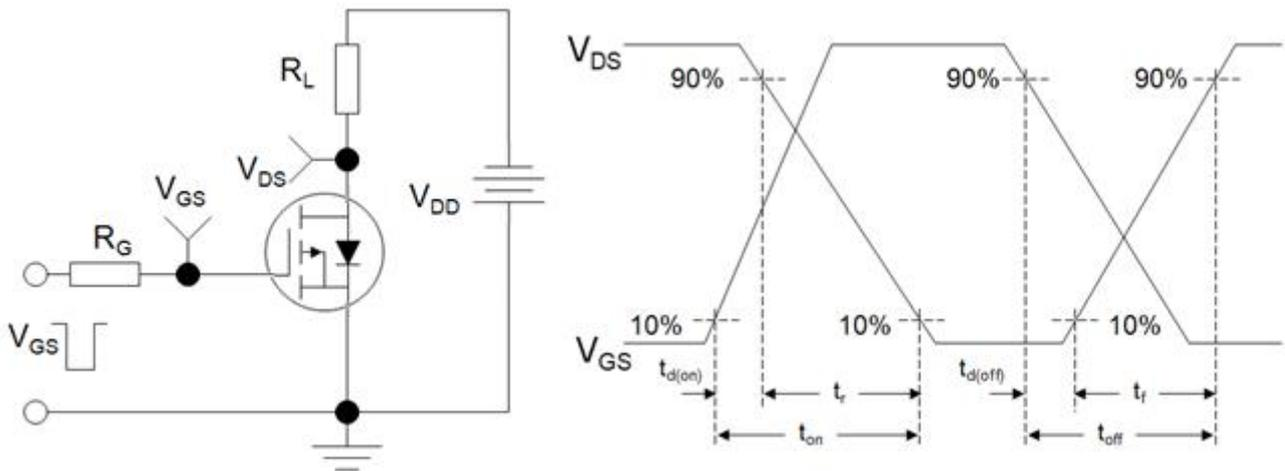

EAS Test Circuit

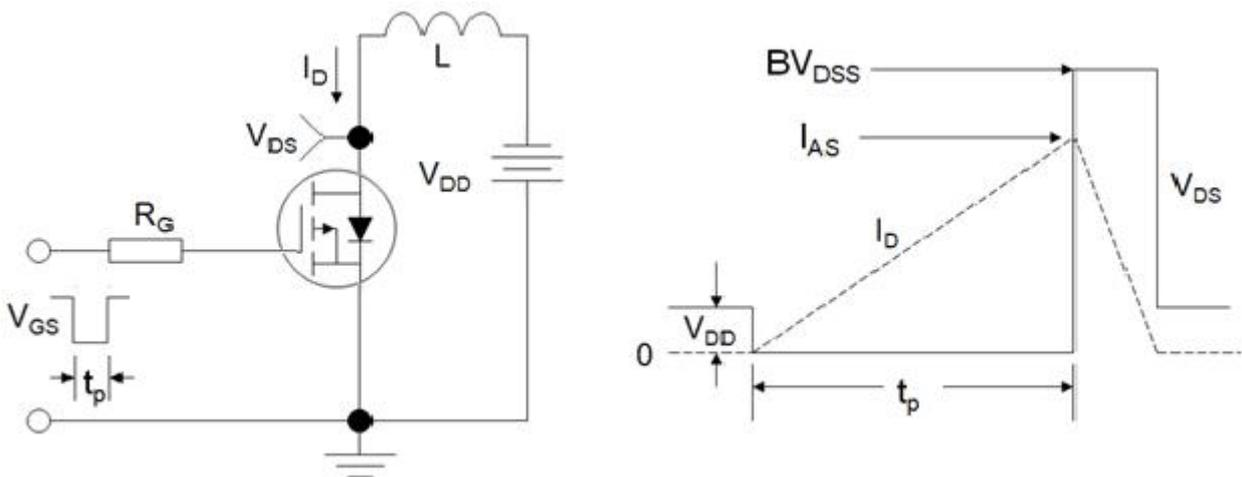

Typical Characteristics $T_J = 25^\circ\text{C}$, unless otherwise noted

Figure 1. Output Characteristics

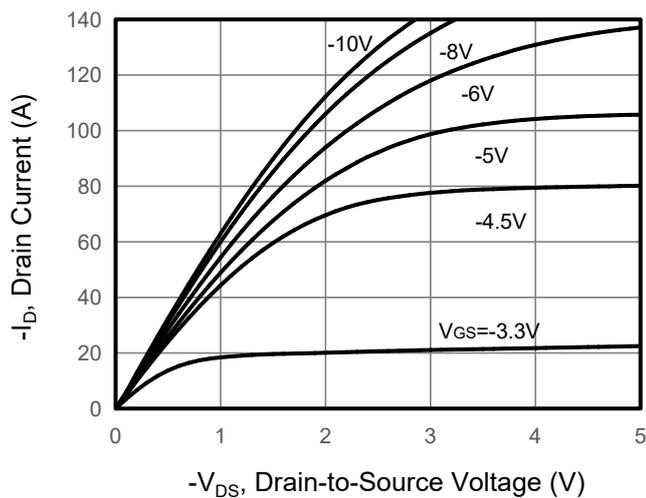

Figure 2. Transfer Characteristics

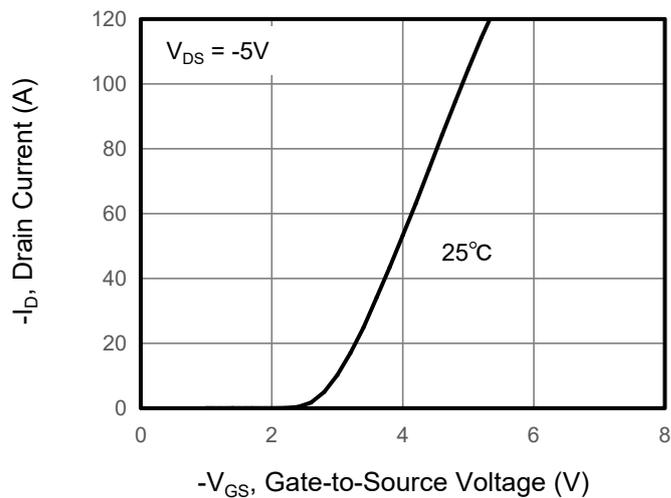

Figure 3. Drain Source On Resistance

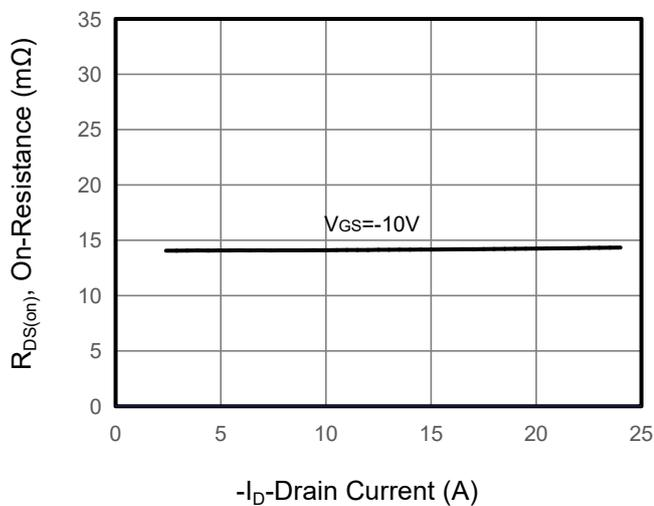

Figure 4. Gate Charge

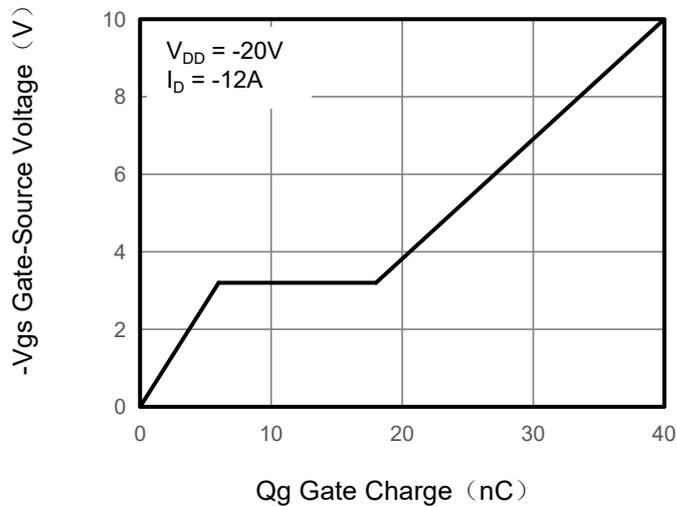

Figure 5. Capacitance

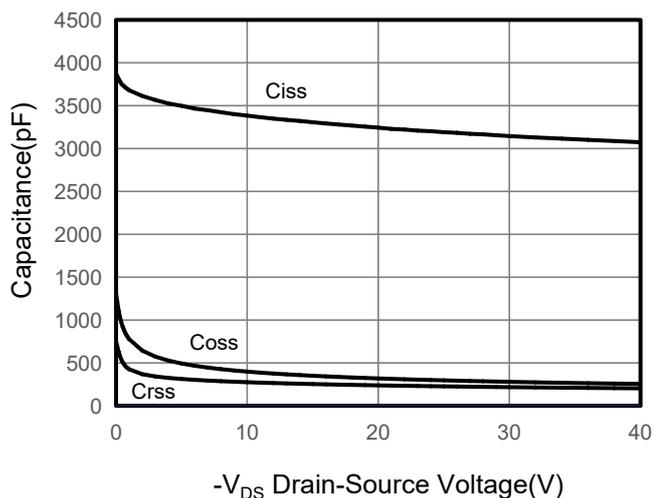
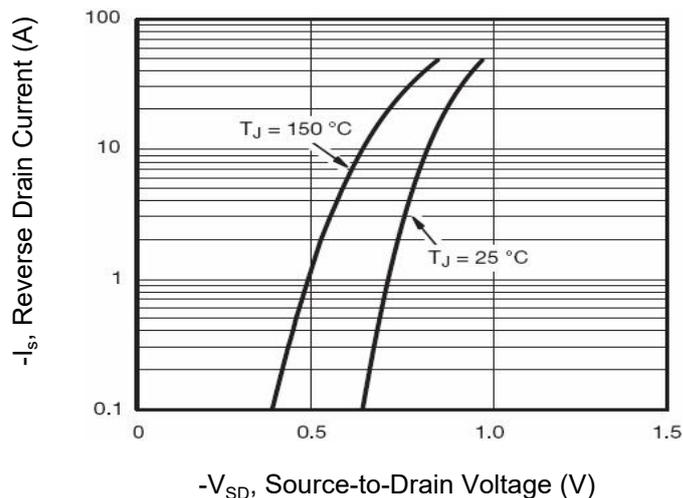

Figure 6. Source-Drain Diode Forward



Typical Characteristics $T_J = 25^\circ\text{C}$, unless otherwise noted

Figure 7. Drain-Source On-Resistance

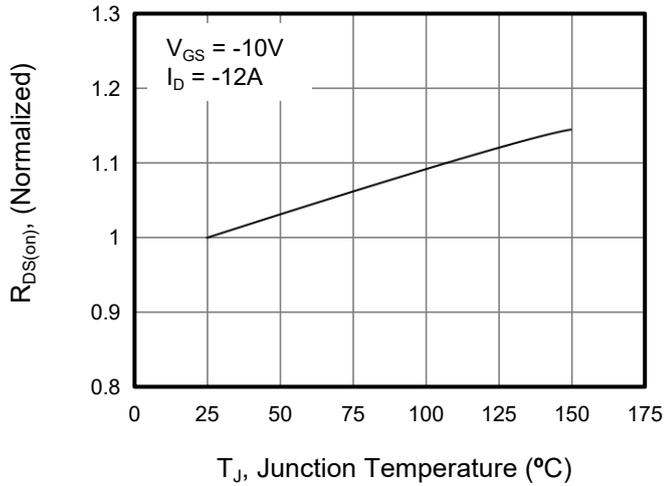

Figure 10. Safe Operation Area

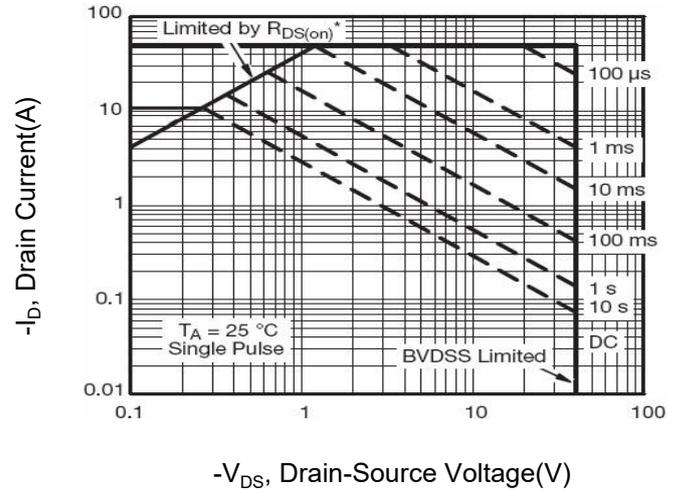
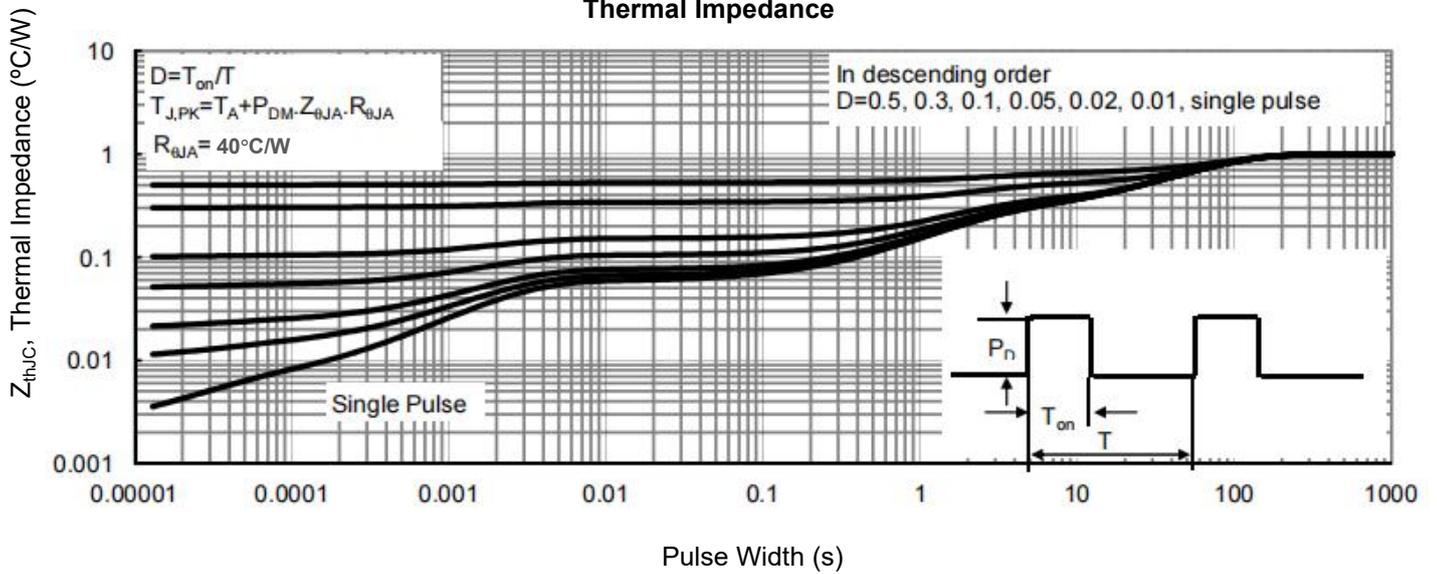
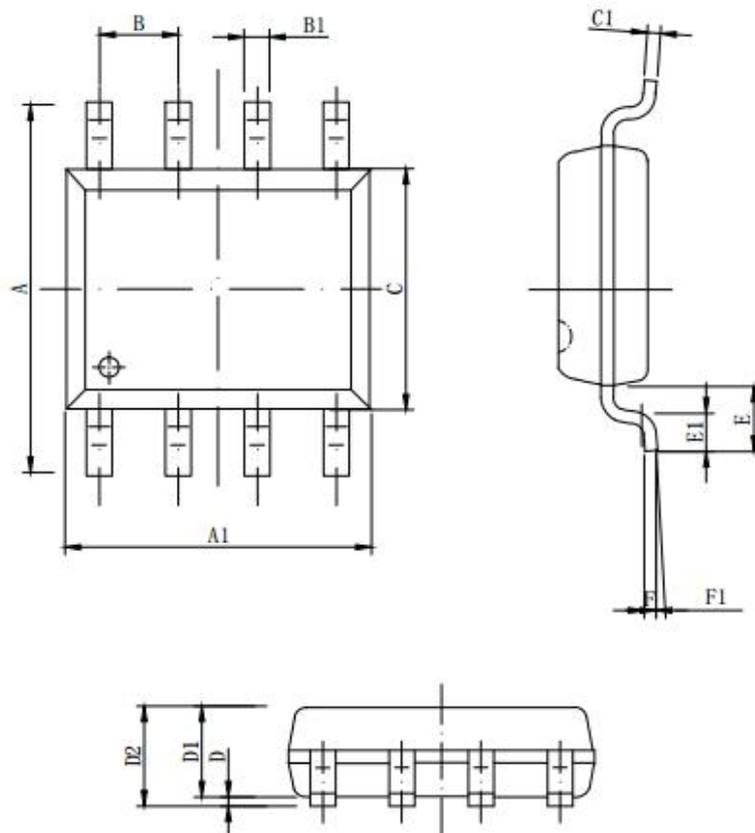

Figure 9. Normalized Maximum Transient Thermal Impedance



SOP-8 Package Information



Symbol	Dimensions in Millimeters		
	MIN.	NOM.	MAX.
A	5.800	6.000	6.200
A1	4.800	4.900	5.000
B	1.270BSC		
B1	0.35 ^{8x}	0.40 ^{8x}	0.45 ^{8x}
C	3.780	3.880	3.980
C1	--	0.203	0.253
D	0.050	0.150	0.250
D1	1.350	1.450	1.550
D2	1.500	1.600	1.700
D2	1.500	1.600	1.700
E	1.060REF		
E1	0.400	0.700	0.100
F	0.250BSC		
F1	2°	4°	6°