

P-Channel Enhancement Mode Power MOSFET

Description

The G120P06T uses advanced trench technology to provide excellent $R_{DS(ON)}$, low gate charge. It can be used in a wide variety of applications.

General Features

- V_{DS} -60V
- I_D (at $V_{GS} = -10V$) -120A
- $R_{DS(ON)}$ (at $V_{GS} = -10V$) < 8.5m Ω
- 100% Avalanche Tested
- RoHS Compliant

Application

- Power switch
- DC/DC converters

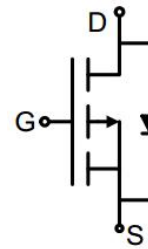

Schematic diagram



TO-220

Ordering Information

Device	Package	Marking	Packaging
G120P06T	TO-220	G120P06	50pcs/Tube

Absolute Maximum Ratings $T_C = 25^\circ C$, unless otherwise noted

Parameter	Symbol	Value	Unit
Drain-Source Voltage	V_{DS}	-60	V
Continuous Drain Current	I_D	-120	A
Pulsed Drain Current (note1)	I_{DM}	-480	A
Gate-Source Voltage	V_{GS}	± 20	V
Power Dissipation	P_D	277	W
Single pulse avalanche energy (note2)	E_{AS}	650	mJ
Operating Junction and Storage Temperature Range	T_J, T_{stg}	-55 To 150	$^\circ C$

Thermal Resistance

Parameter	Symbol	Value	Unit
Thermal Resistance, Junction-to-Ambient	R_{thJA}	65	$^\circ C/W$
Maximum Junction-to-Case	R_{thJC}	0.45	$^\circ C/W$

Specifications $T_J = 25^\circ\text{C}$, unless otherwise noted						
Parameter	Symbol	Test Conditions	Value			Unit
			Min.	Typ.	Max.	
Static Parameters						
Drain-Source Breakdown Voltage	$V_{(BR)DSS}$	$V_{GS} = 0V, I_D = -250\mu A$	-60	--	--	V
Zero Gate Voltage Drain Current	I_{DSS}	$V_{DS} = -60V, V_{GS} = 0V$	--	--	-1	μA
Gate-Source Leakage	I_{GSS}	$V_{GS} = \pm 20V$	--	--	± 100	nA
Gate-Source Threshold Voltage	$V_{GS(th)}$	$V_{DS} = V_{GS}, I_D = -250\mu A$	-1	-2.5	-3	V
Drain-Source On-Resistance	$R_{DS(on)}$	$V_{GS} = -10V, I_D = -20A$	--	7	8.5	m Ω
Forward Transconductance	g_{FS}	$V_{DS} = -5V, I_D = -20A$	--	35	--	S
Dynamic Parameters						
Input Capacitance	C_{iss}	$V_{GS} = 0V,$ $V_{DS} = -30V,$ $f = 1.0\text{MHz}$	--	12674	--	pF
Output Capacitance	C_{oss}		--	935	--	
Reverse Transfer Capacitance	C_{rss}		--	671	--	
Total Gate Charge	Q_g	$V_{DD} = -30V,$ $I_D = -60A,$ $V_{GS} = -10V$	--	230	--	nC
Gate-Source Charge	Q_{gs}		--	50	--	
Gate-Drain Charge	Q_{gd}		--	35	--	
Turn-on Delay Time	$t_{d(on)}$	$V_{DD} = -30V,$ $I_D = -60A,$ $R_G = 1\Omega$	--	20	--	ns
Turn-on Rise Time	t_r		--	25	--	
Turn-off Delay Time	$t_{d(off)}$		--	110	--	
Turn-off Fall Time	t_f		--	50	--	
Drain-Source Body Diode Characteristics						
Continuous Body Diode Current	I_S	$T_C = 25^\circ\text{C}$	--	--	-60	A
Body Diode Voltage	V_{SD}	$T_J = 25^\circ\text{C}, I_{SD} = -20A, V_{GS} = 0V$	--	--	-1.2	V
Reverse Recovery Charge	Q_{rr}	$I_F = -30A, V_{GS} = 0V$ $di/dt = -100A/\mu s$	--	0.21	--	nC
Reverse Recovery Time	T_{rr}		--	91	--	ns

Notes

1. Repetitive Rating: Pulse width limited by maximum junction temperature
2. EAS condition : $T_J = 25^\circ\text{C}, V_{DD} = -50V, V_{GS} = -10V, L = 0.5\text{mH}, R_g = 25\Omega$

Gate Charge Test Circuit



Switch Time Test Circuit



EAS Test Circuit

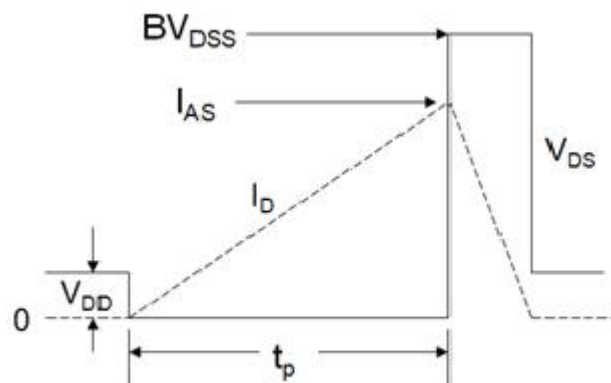

Typical Characteristics $T_J = 25^\circ\text{C}$, unless otherwise noted

Figure 1. Output Characteristics

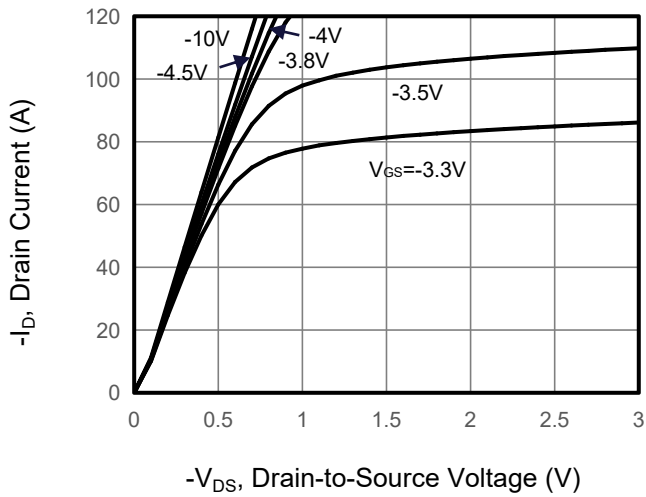

Figure 2. Transfer Characteristics

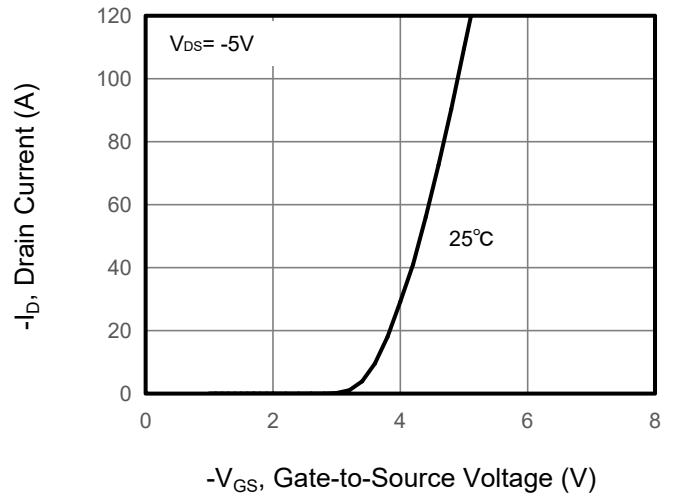

Figure 3. Drain Source On Resistance

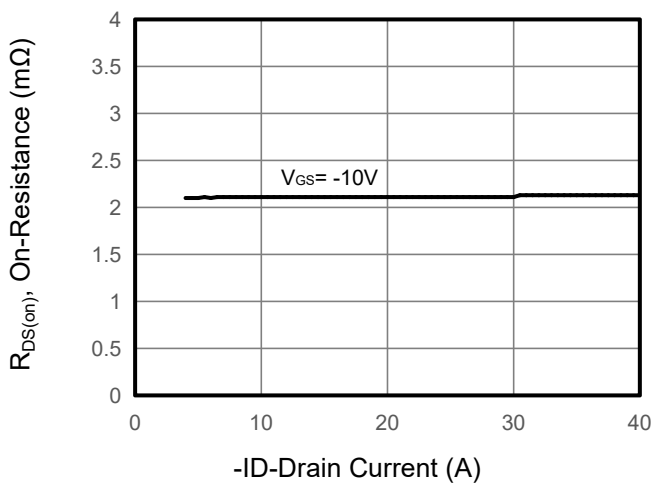

Figure 4. Gate Charge

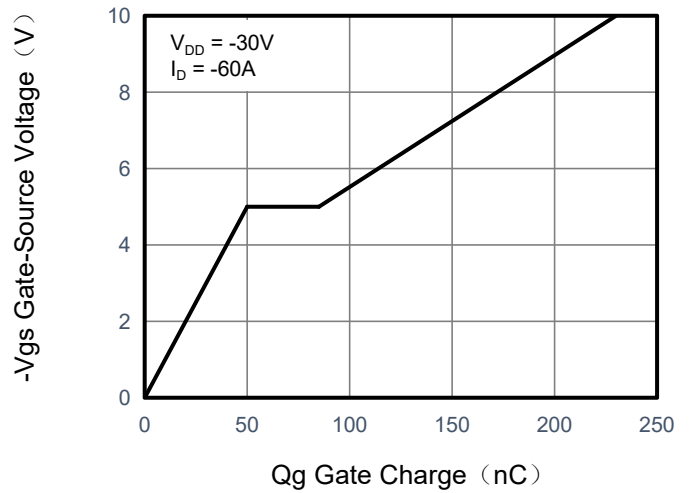

Figure 5. Capacitance

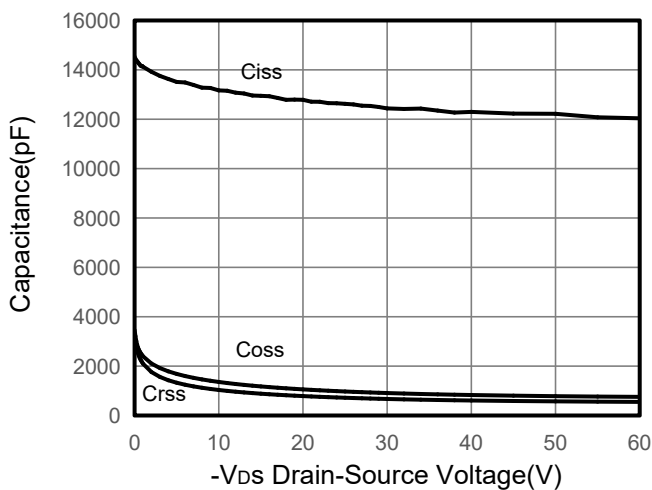
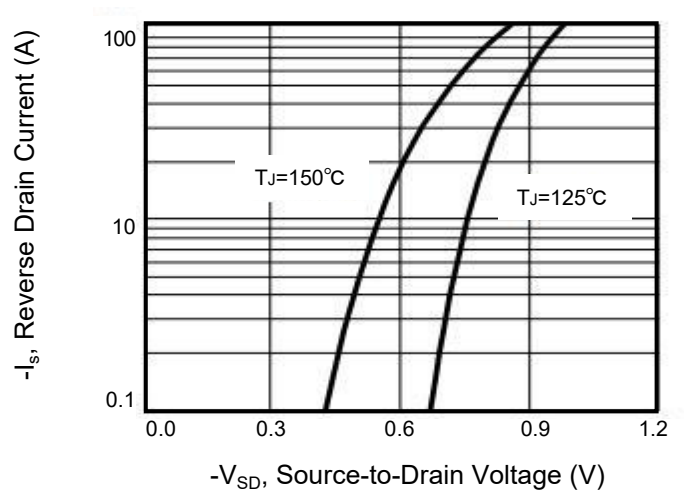

Figure 6. Source-Drain Diode Forward



Typical Characteristics $T_J = 25^\circ\text{C}$, unless otherwise noted

Figure 7. Drain-Source On-Resistance

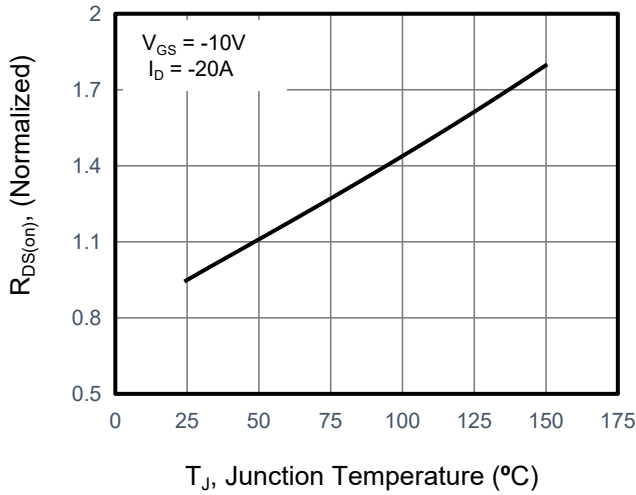

Figure 10. Safe Operation Area

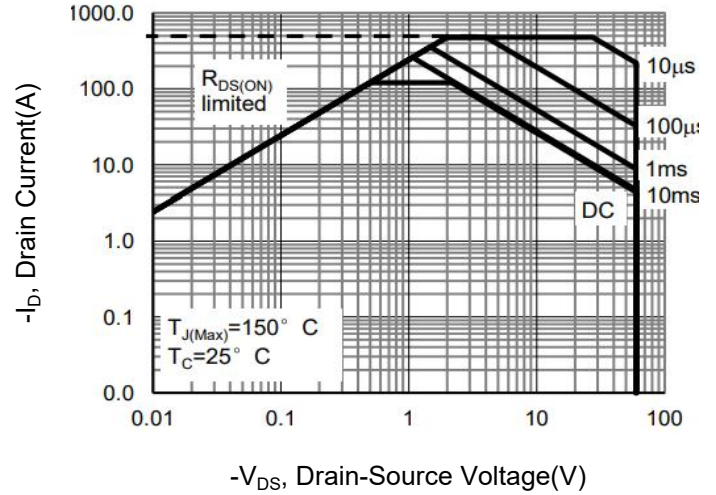
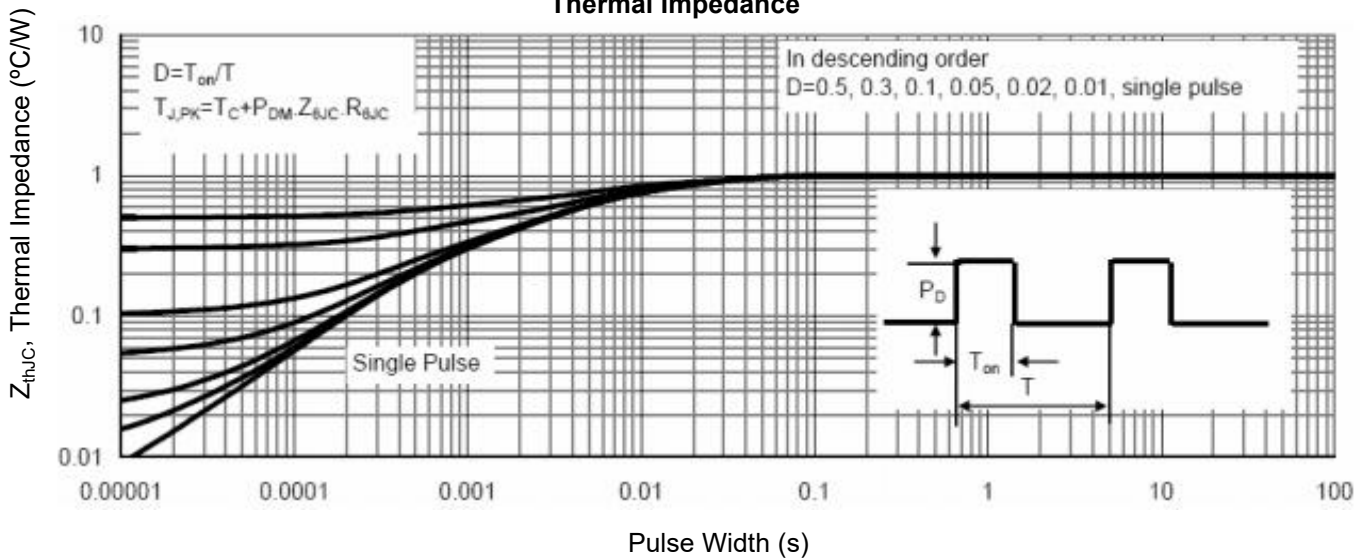
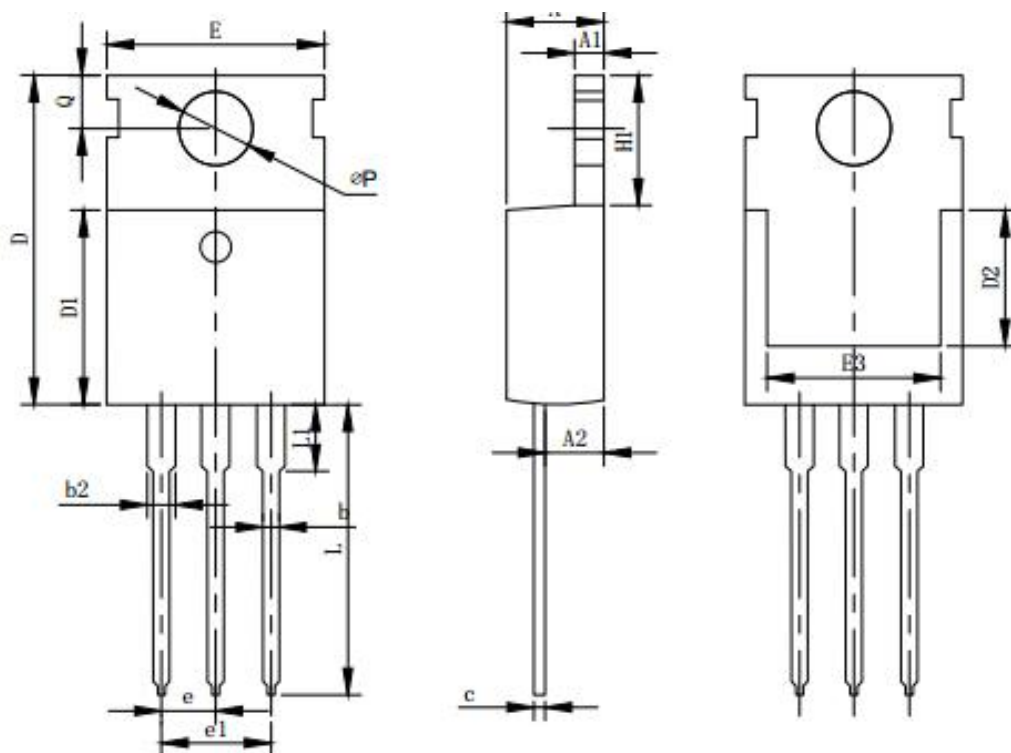

Figure 9. Normalized Maximum Transient Thermal Impedance



TO-220 Package Information



Symbol	Dimensions in Millimeters		
	MIN.	NOM.	MAX.
A	4.37	4.57	4.7
A1	1.25	1.3	1.4
A2	2.2	2.4	2.6
b	0.7	0.8	0.95
b2	1.7	1.27	1.47
c	0.45	0.5	0.6
D	15.1	15.6	16.1
D1	8.8	9.1	9.4
D2	5.5		
E	9.7	10	10.3
e	2.54BSC		
e1	5.08BSC		
H1	6.25	6.5	6.85
L	12.75	13.5	13.8
L1		3.1	3.4
∅ P	3.4	3.6	3.8
Q	2.6	2.8	3