

## N-Channel Enhancement Mode Power MOSFET

### Description

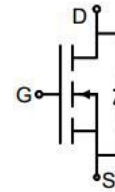
The G06N06S uses advanced trench technology to provide excellent  $R_{DS(ON)}$ , low gate charge. It can be used in a wide variety of applications.

### General Features

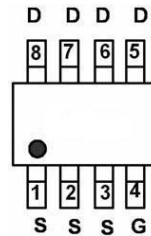
- $V_{DS}$  60V
- $I_D$  (at  $V_{GS} = 10V$ ) 8A
- $R_{DS(ON)}$  (at  $V_{GS} = 10V$ ) < 22m $\Omega$
- $R_{DS(ON)}$  (at  $V_{GS} = 4.5V$ ) < 35m $\Omega$
- 100% Avalanche Tested
- RoHS Compliant

### Application

- Power switch
- DC/DC converters



Schematic diagram



pin assignment



SOP-8

### Ordering Information

Device	Package	Marking	Packaging
G06N06S	SOP-8	G06N06	4000psc/Reel

### Absolute Maximum Ratings $T_C = 25^\circ\text{C}$ , unless otherwise noted

Parameter	Symbol	Value	Unit
Drain-Source Voltage	$V_{DS}$	60	V
Continuous Drain Current	$I_D$	8	A
Pulsed Drain Current (note1)	$I_{DM}$	32	A
Gate-Source Voltage	$V_{GS}$	$\pm 20$	V
Power Dissipation	$P_D$	2.1	W
Operating Junction and Storage Temperature Range	$T_J, T_{stg}$	-55 To 150	$^\circ\text{C}$

### Thermal Resistance

Parameter	Symbol	Value	Unit
Thermal Resistance, Junction-to-Ambient	$R_{thJA}$	60	$^\circ\text{C/W}$

Specifications $T_J = 25^\circ\text{C}$ , unless otherwise noted						
Parameter	Symbol	Test Conditions	Value			Unit
			Min.	Typ.	Max.	
<b>Static Parameters</b>						
Drain-Source Breakdown Voltage	$V_{(BR)DSS}$	$V_{GS} = 0V, I_D = 250\mu A$	60	--	--	V
Zero Gate Voltage Drain Current	$I_{DSS}$	$V_{DS} = 60V, V_{GS} = 0V$	--	--	1	$\mu A$
Gate-Source Leakage	$I_{GSS}$	$V_{GS} = \pm 20V$	--	--	$\pm 100$	nA
Gate-Source Threshold Voltage	$V_{GS(th)}$	$V_{DS} = V_{GS}, I_D = 250\mu A$	1.2	1.4	2.4	V
Drain-Source On-Resistance	$R_{DS(on)}$	$V_{GS} = 10V, I_D = 6A$	--	15	22	m $\Omega$
		$V_{GS} = 4.5V, I_D = 6A$	--	16.5	35	
Forward Transconductance	$g_{FS}$	$V_{GS} = 5V, I_D = 6A$	--	16	--	S
<b>Dynamic Parameters</b>						
Input Capacitance	$C_{iss}$	$V_{GS} = 0V,$ $V_{DS} = 30V,$ $f = 1.0\text{MHz}$	--	2477	--	pF
Output Capacitance	$C_{oss}$		--	142	--	
Reverse Transfer Capacitance	$C_{rss}$		--	139	--	
Total Gate Charge	$Q_g$	$V_{DD} = 30V,$ $I_D = 6A,$ $V_{GS} = 10V$	--	46	--	nC
Gate-Source Charge	$Q_{gs}$		--	5.5	--	
Gate-Drain Charge	$Q_{gd}$		--	13.4	--	
Turn-on Delay Time	$t_{d(on)}$	$V_{DD} = 30V,$ $I_D = 6A,$ $R_G = 3\Omega$	--	7	--	ns
Turn-on Rise Time	$t_r$		--	5.5	--	
Turn-off Delay Time	$t_{d(off)}$		--	29	--	
Turn-off Fall Time	$t_f$		--	4.5	--	
<b>Drain-Source Body Diode Characteristics</b>						
Continuous Body Diode Current	$I_S$	$T_C = 25^\circ\text{C}$	--	--	8	A
Body Diode Voltage	$V_{SD}$	$T_J = 25^\circ\text{C}, I_{SD} = 6A, V_{GS} = 0V$	--	--	1.2	V
Reverse Recovery Charge	$Q_{rr}$	$I_F = 6A, V_{GS} = 0V$ $di/dt = 300A/\mu s$	--	120	--	nC
Reverse Recovery Time	$T_{rr}$		--	50	--	ns

### Notes

1. Repetitive Rating: Pulse width limited by maximum junction temperature
2. Identical low side and high side switch with identical  $R_G$

### Gate Charge Test Circuit



### Switch Time Test Circuit

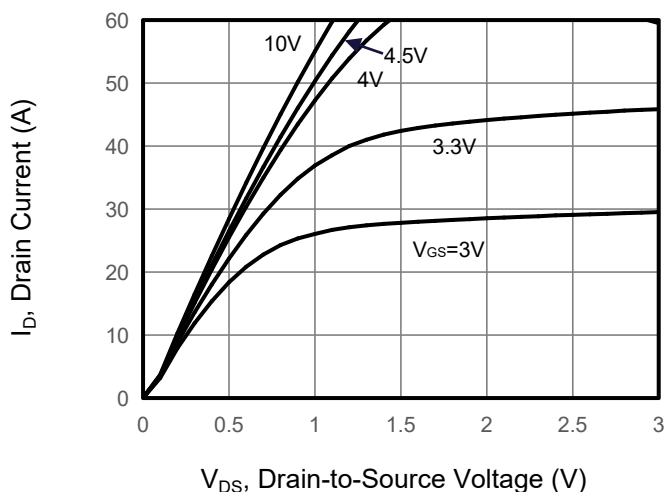


### EAS Test Circuit

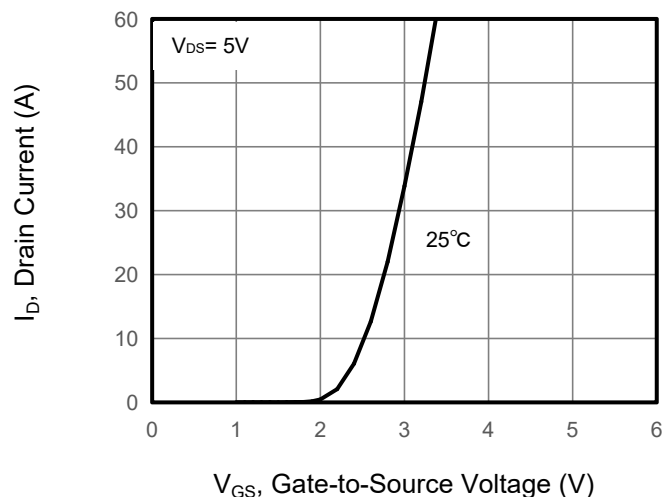


Typical Characteristics  $T_J = 25^\circ\text{C}$ , unless otherwise noted

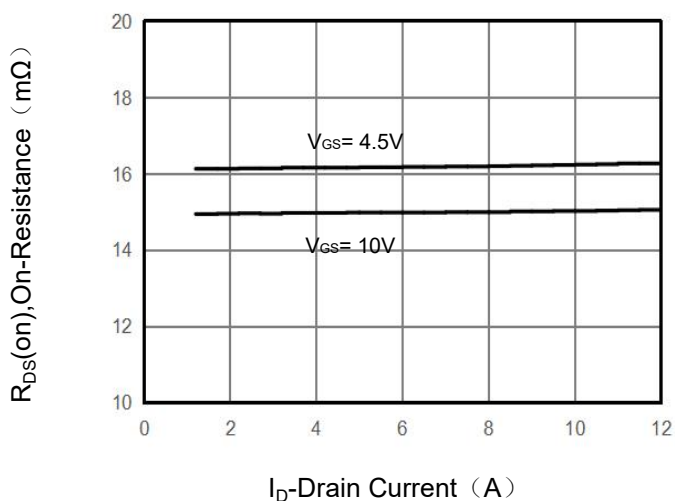
**Figure 1. Output Characteristics**



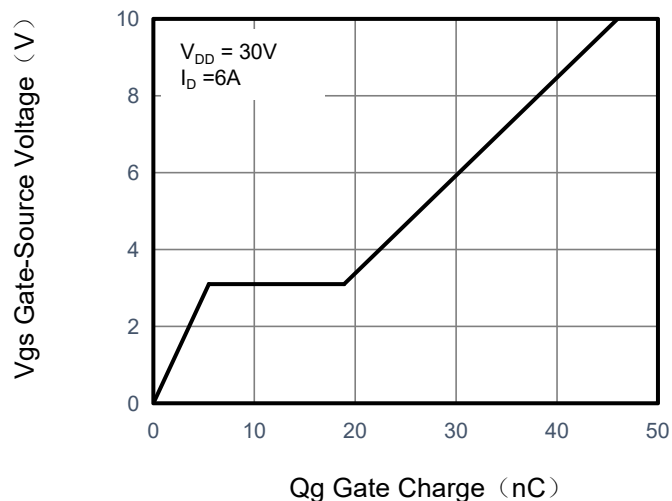
**Figure 2. Transfer Characteristics**



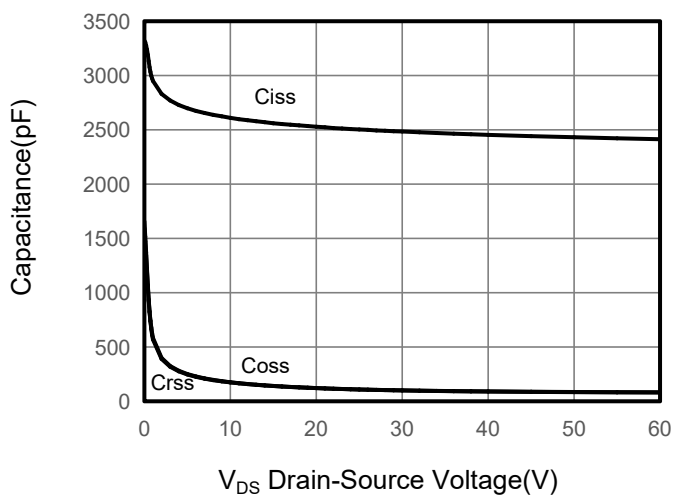
**Figure 3. Drain Source On Resistance**



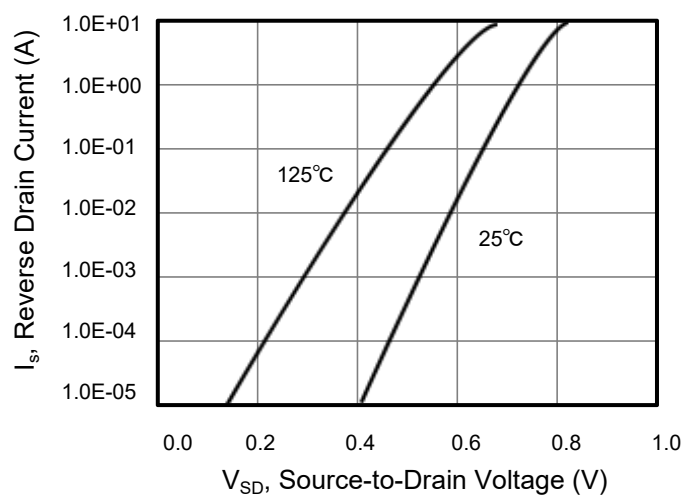
**Figure 4. Gate Charge**



**Figure 5. Capacitance**

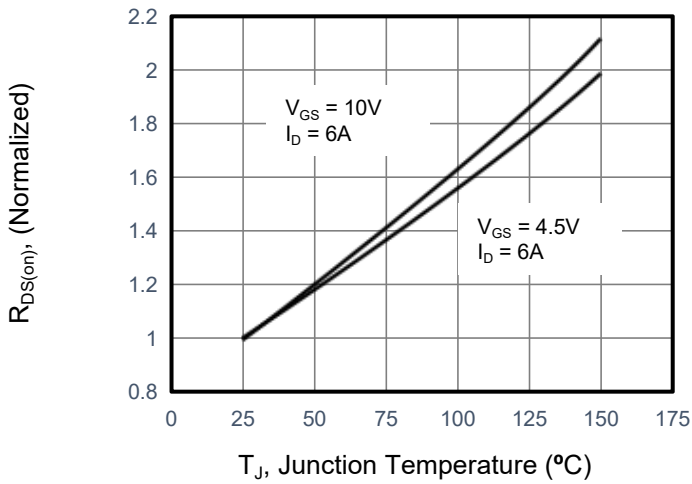


**Figure 6. Source-Drain Diode Forward**

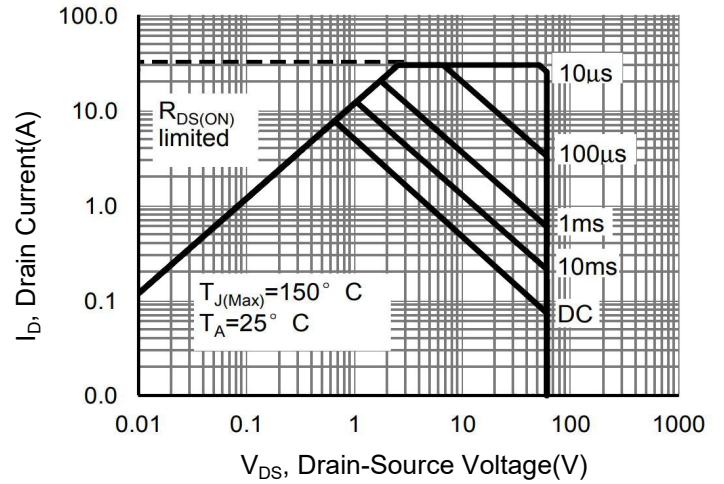


## Typical Characteristics $T_J = 25^\circ\text{C}$ , unless otherwise noted

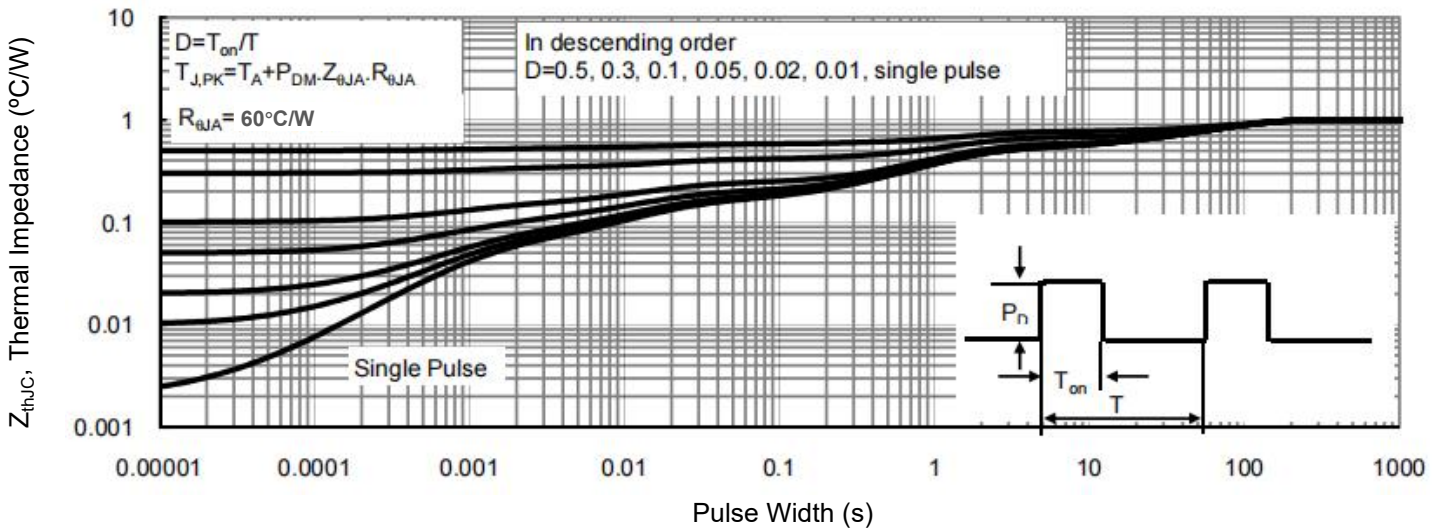
**Figure 7. Drain-Source On-Resistance**



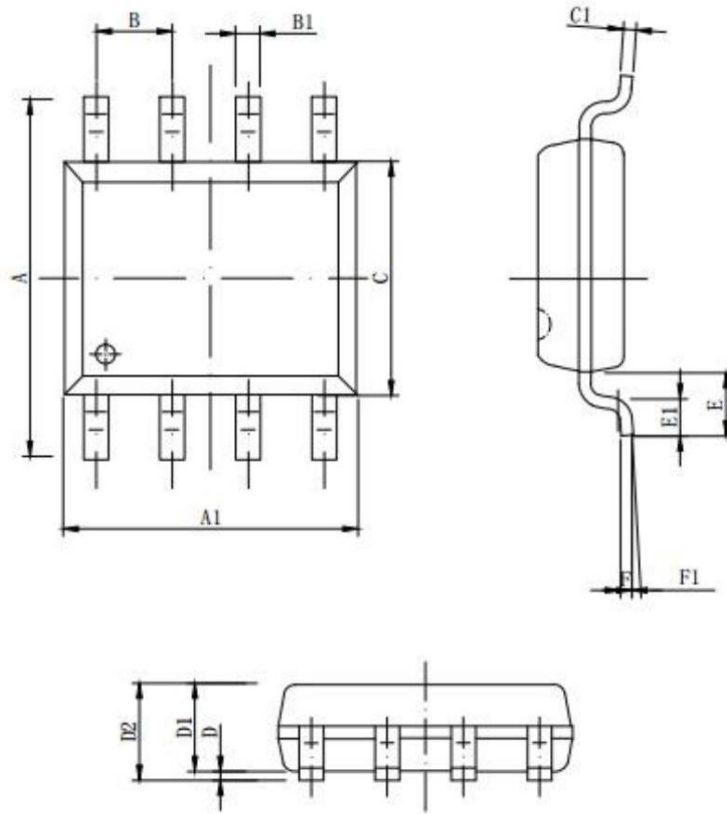
**Figure 8. Safe Operation Area**



**Figure 9. Normalized Maximum Transient Thermal Impedance**



## SOP-8 Package Information



Symbol	Dimensions in Millimeters		
	MIN.	NOM.	MAX.
A	5.800	6.000	6.200
A1	4.800	4.900	5.000
B	1.270BSC		
B1	0.35 <sup>^</sup> 8x	0.40 <sup>^</sup> 8x	0.45 <sup>^</sup> 8x
C	3.780	3.880	3.980
C1	--	0.203	0.253
D	0.050	0.150	0.250
D1	1.350	1.450	1.550
D2	1.500	1.600	1.700
D2	1.500	1.600	1.700
E	1.060REF		
E1	0.400	0.700	0.100
F	0.250BSC		
F1	2°	4°	6°