

P-Channel Enhancement Mode Power MOSFET

Description

The G40P03K uses advanced trench technology to provide excellent $R_{DS(ON)}$, low gate charge. It can be used in a wide variety of applications.

General Features

- V_{DS} -30V
- I_D (at $V_{GS} = -10V$) -40A
- $R_{DS(ON)}$ (at $V_{GS} = -10V$) < 13m Ω
- $R_{DS(ON)}$ (at $V_{GS} = -4.5V$) < 23m Ω
- 100% Avalanche Tested
- RoHS Compliant

Application

- Power switch
- DC/DC converters

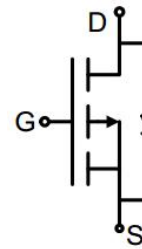

Schematic diagram

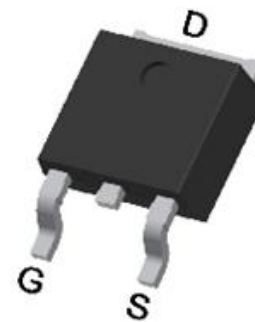

TO-252

Ordering Information

| Device | Package | Marking | Packaging |
|---------|---------|---------|--------------|
| G40P03K | TO-252 | G40P03 | 2500pcs/Reel |

Absolute Maximum Ratings $T_C = 25^\circ\text{C}$, unless otherwise noted

| Parameter | Symbol | Value | Unit |
|--|----------------|------------|------------------|
| Drain-Source Voltage | V_{DS} | -30 | V |
| Continuous Drain Current | I_D | -40 | A |
| Pulsed Drain Current (note1) | I_{DM} | -160 | A |
| Gate-Source Voltage | V_{GS} | ± 20 | V |
| Power Dissipation | P_D | 78 | W |
| Single pulse avalanche energy (note2) | E_{AS} | 72 | mJ |
| Operating Junction and Storage Temperature Range | T_J, T_{stg} | -55 To 150 | $^\circ\text{C}$ |

Thermal Resistance

| Parameter | Symbol | Value | Unit |
|---|------------|-------|--------------------|
| Thermal Resistance, Junction-to-Ambient | R_{thJA} | 50 | $^\circ\text{C/W}$ |
| Maximum Junction-to-Case | R_{thJC} | 1.6 | $^\circ\text{C/W}$ |

| Specifications $T_J = 25^\circ\text{C}$, unless otherwise noted | | | | | | |
|--|---------------|---|-------|------|-----------|------------|
| Parameter | Symbol | Test Conditions | Value | | | Unit |
| | | | Min. | Typ. | Max. | |
| Static Parameters | | | | | | |
| Drain-Source Breakdown Voltage | $V_{(BR)DSS}$ | $V_{GS} = 0V, I_D = -250\mu A$ | -30 | -- | -- | V |
| Zero Gate Voltage Drain Current | I_{DSS} | $V_{DS} = -30V, V_{GS} = 0V$ | -- | -- | -1 | μA |
| Gate-Source Leakage | I_{GSS} | $V_{GS} = \pm 20V$ | -- | -- | ± 100 | nA |
| Gate-Source Threshold Voltage | $V_{GS(th)}$ | $V_{DS} = V_{GS}, I_D = -250\mu A$ | -1 | -1.5 | -2.5 | V |
| Drain-Source On-Resistance | $R_{DS(on)}$ | $V_{GS} = -10V, I_D = -15A$ | -- | 7.5 | 13 | m Ω |
| | | $V_{GS} = -4.5V, I_D = -10A$ | -- | 10 | 23 | |
| Forward Transconductance | g_{FS} | $V_{DS} = -5V, I_D = -10A$ | -- | 52 | -- | S |
| Dynamic Parameters | | | | | | |
| Input Capacitance | C_{iss} | $V_{GS} = 0V,$ $V_{DS} = -15V,$ $f = 1.0MHz$ | -- | 2622 | -- | pF |
| Output Capacitance | C_{oss} | | -- | 348 | -- | |
| Reverse Transfer Capacitance | C_{rss} | | -- | 346 | -- | |
| Total Gate Charge | Q_g | $V_{DD} = -15V,$ $I_D = -10A,$ $V_{GS} = -10V$ | -- | 50 | -- | nC |
| Gate-Source Charge | Q_{gs} | | -- | 9 | -- | |
| Gate-Drain Charge | Q_{gd} | | -- | 12 | -- | |
| Turn-on Delay Time | $t_{d(on)}$ | $V_{DD} = -15V,$ $I_D = -10A,$ $R_G = -3\Omega$ | -- | 18 | -- | ns |
| Turn-on Rise Time | t_r | | -- | 12.5 | -- | |
| Turn-off Delay Time | $t_{d(off)}$ | | -- | 125 | -- | |
| Turn-off Fall Time | t_f | | -- | 66 | -- | |
| Drain-Source Body Diode Characteristics | | | | | | |
| Continuous Body Diode Current | I_S | $T_C = 25^\circ\text{C}$ | -- | -- | -40 | A |
| Body Diode Voltage | V_{SD} | $T_J = 25^\circ\text{C}, I_{SD} = -15A, V_{GS} = 0V$ | -- | -- | -1.2 | V |
| Reverse Recovery Charge | Q_{rr} | $I_F = -20A, V_{GS} = 0V$ $di/dt = -500A/\mu s$ | -- | 62 | -- | nC |
| Reverse Recovery Time | T_{rr} | | -- | 32 | -- | ns |

Notes

1. Repetitive Rating: Pulse width limited by maximum junction temperature
2. EAS condition : $T_J = 25^\circ\text{C}, V_{DD} = -30V, V_{GS} = -10V, L = 0.5mH, R_G = 25\Omega$
3. Identical low side and high side switch with identical R_G

Gate Charge Test Circuit

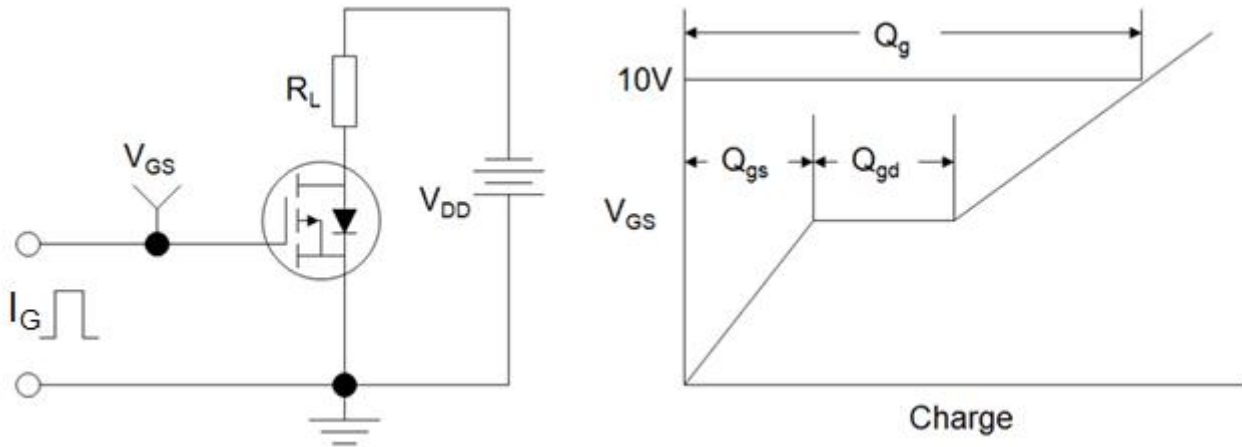

Switch Time Test Circuit

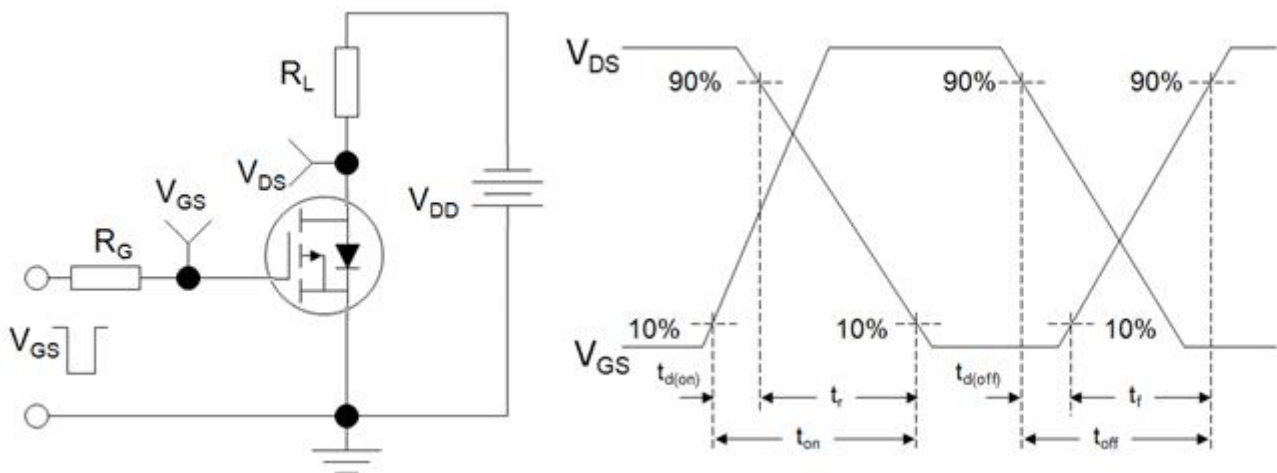

EAS Test Circuit

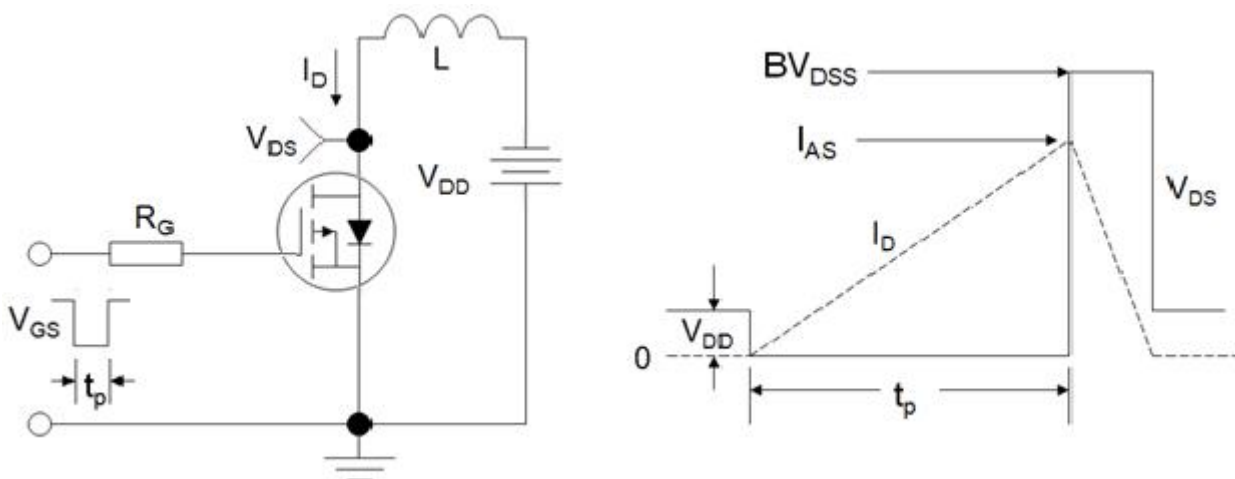

Typical Characteristics $T_J = 25^\circ\text{C}$, unless otherwise noted

Figure 1. Output Characteristics

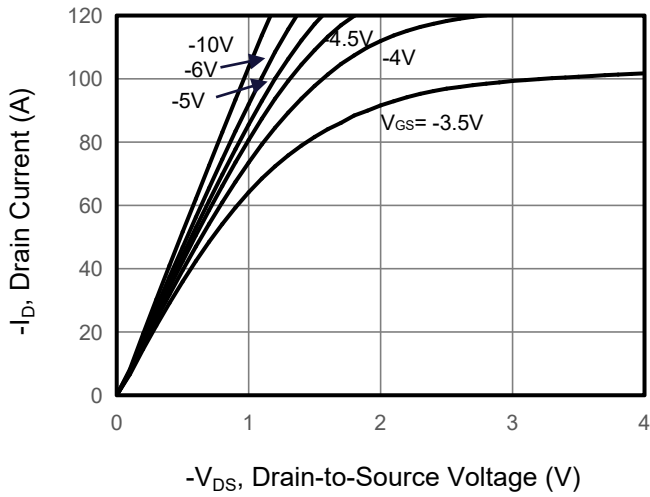

Figure 2. Transfer Characteristics

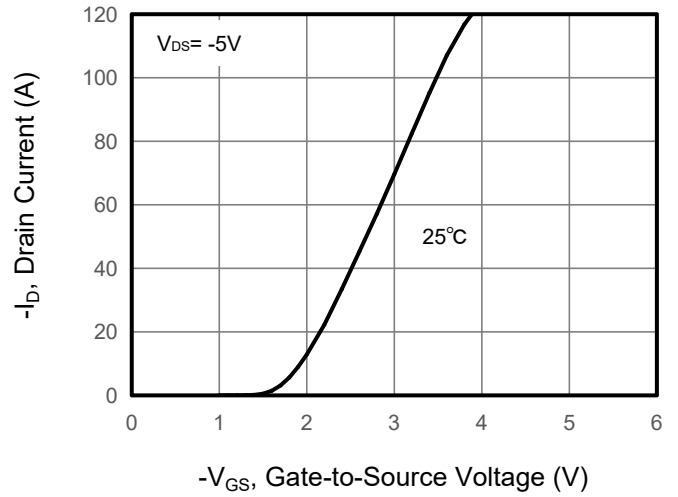

Figure 3. Drain Source On Resistance

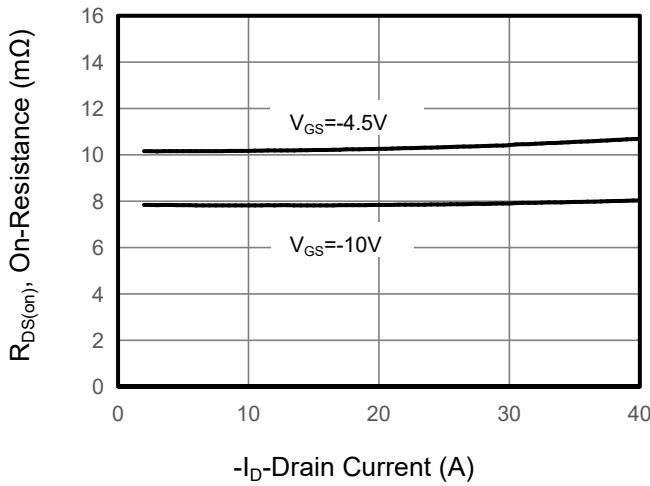

Figure 4. Gate Charge

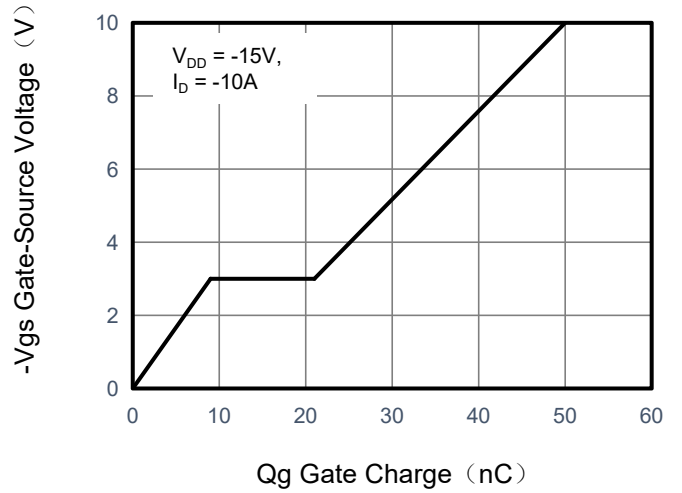

Figure 5. Capacitance

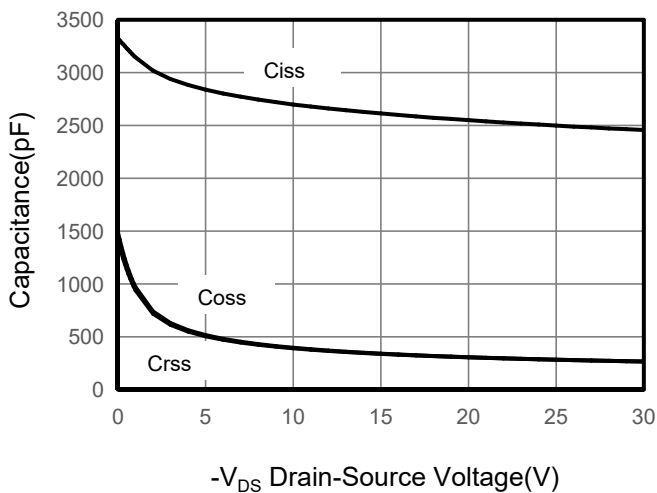
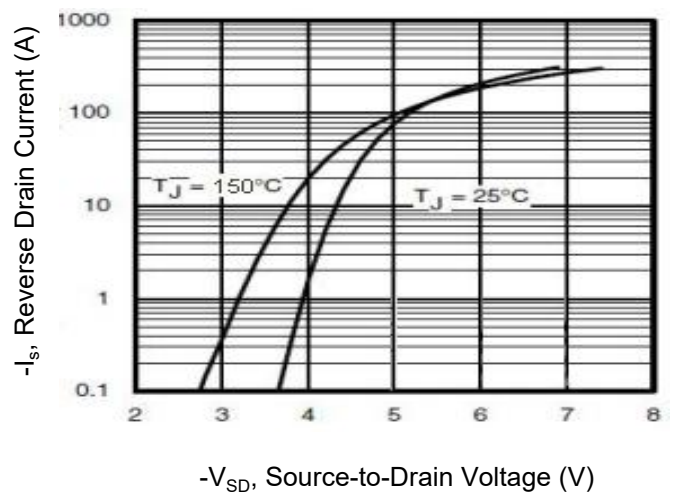

Figure 6. Source-Drain Diode Forward



Typical Characteristics $T_J = 25^\circ\text{C}$, unless otherwise noted

Figure 7. Drain-Source On-Resistance

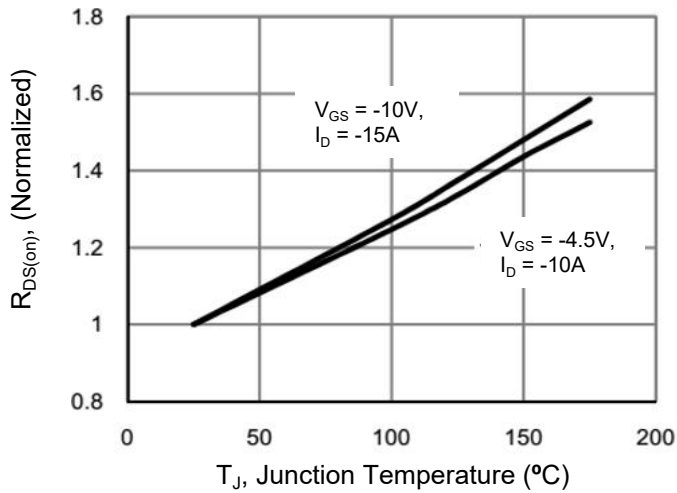

Figure 10. Safe Operation Area

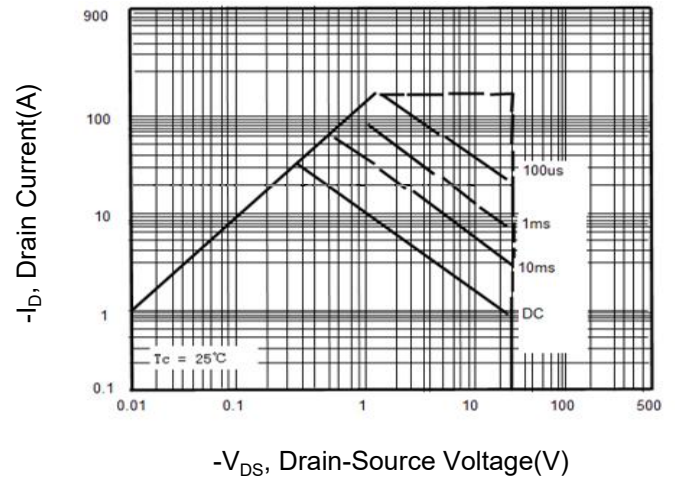
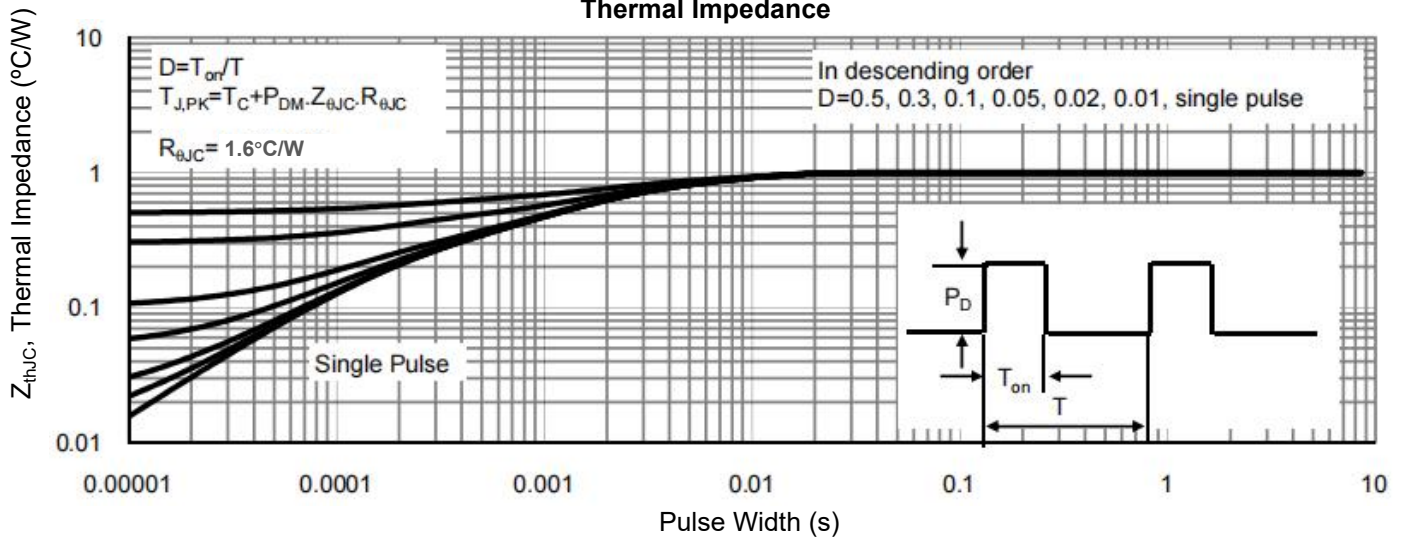
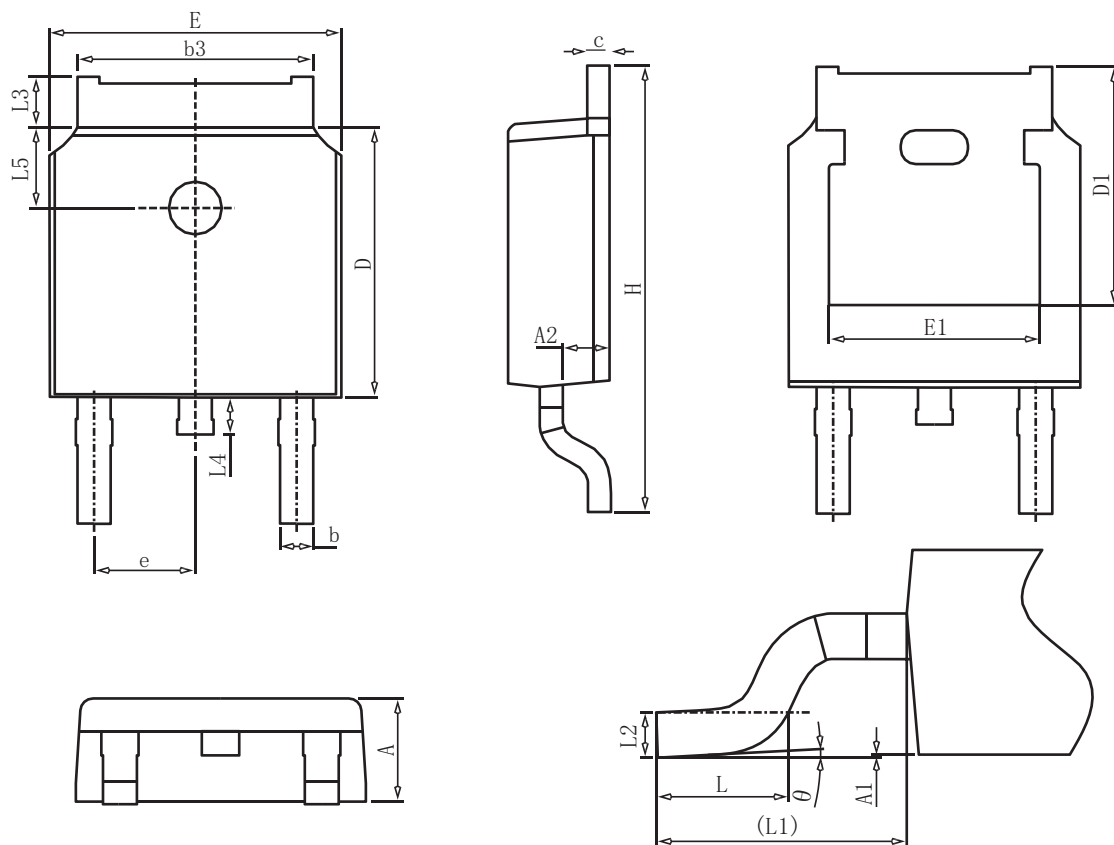

Figure 9. Normalized Maximum Transient Thermal Impedance



TO-252 Package information



COMMON DIMENSIONS

| SYMBOL | mm | | |
|--------|----------|-------|-------|
| | MIN | NOM | MAX |
| A | 2.20 | 2.30 | 2.40 |
| A1 | 0.00 | - | 0.20 |
| A2 | 0.97 | 1.07 | 1.17 |
| b | 0.68 | 0.78 | 0.90 |
| b3 | 5.20 | 5.33 | 5.50 |
| c | 0.43 | 0.53 | 0.63 |
| D | 5.98 | 6.10 | 6.22 |
| D1 | 5.30REF | | |
| E | 6.40 | 6.60 | 6.80 |
| E1 | 4.63 | - | - |
| e | 2.286BSC | | |
| H | 9.40 | 10.10 | 10.50 |
| L | 1.38 | 1.50 | 1.75 |
| L1 | 2.90REF | | |
| L2 | 0.51BSC | | |
| L3 | 0.88 | - | 1.28 |
| L4 | 0.50 | - | 1.00 |
| L5 | 1.65 | 1.80 | 1.95 |
| θ | 0° | - | 8° |