

ISL80410

40V, Low Quiescent Current, High Accuracy, 150mA Linear Regulator

FN8983
Rev.2.00
Aug 8, 2019

The [ISL80410](#) is a high voltage, adjustable V_{OUT} , low quiescent current linear regulator ideally suited for “always-on” and “keep alive” applications. The ISL80410 operates from an input voltage of +6V to +40V under normal operating conditions and consumes only 18 μ A of quiescent current at no load.

The ISL80410 features an EN pin that can be used to put the device into a low-quiescent current shutdown mode in which it draws only 2 μ A of supply current. The device features over-temperature shutdown and current limit protection.

The ISL80410 is rated to operate across the -40°C to +125°C temperature range and is available in an 8 Ld Small Outline Exposed Pad Plastic Package (EPSOIC).

Applications

- Industrial
- Telecommunications

Related Literature

For a full list of related documents, visit our website:

- [ISL80410](#) device page

Features

- Wide V_{IN} range of 6V to 40V
- Adjustable output voltage from 2.5V to 12V
- Ensured 150mA output current
- Ultra low 18 μ A typical quiescent current
- Low 2 μ A of typical shutdown current
- \pm 1% accurate voltage reference (over temperature, load)
- Low dropout voltage of 295mV at 150mA
- Low 26 μ V_{RMS} noise
- 40V tolerant logic level (TTL/CMOS) enable input
- Stable operation with 10 μ F output capacitor
- 5kV ESD HBM rated
- Thermal shutdown and current limit protection
- 8 Ld exposed pad EPSOIC package

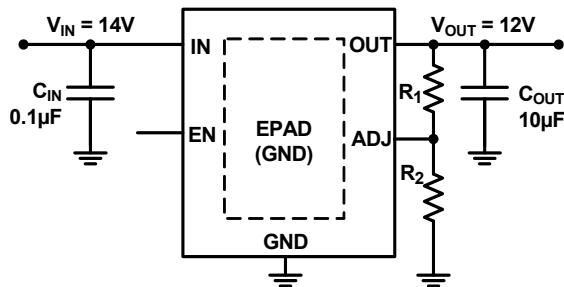

Figure 1. Typical Application

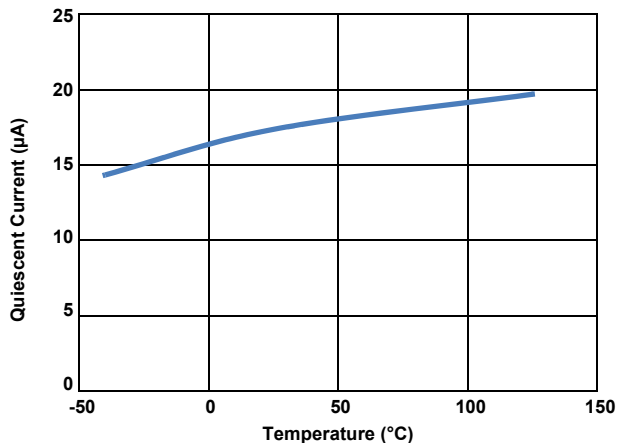

Figure 2. Quiescent Current vs Temperature (at Unity Gain), $V_{IN} = 14V$

1. Overview

1.1 Block Diagram

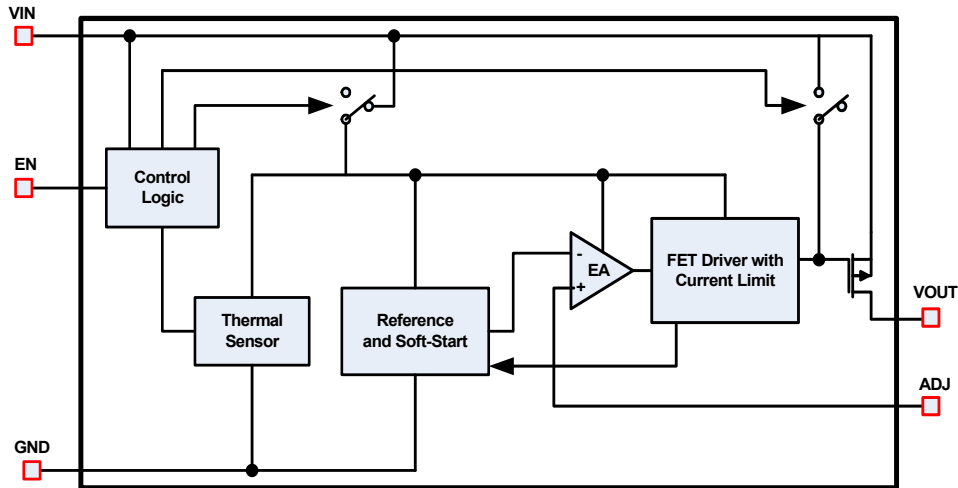

Figure 3. Block Diagram

1.2 Ordering Information

Part Number (Notes 2, 3)	Part Marking	Temp. Range (°C)	Enable Pin	Output Voltage (V)	Tape and Reel (Units) (Note 1)	Package (RoHS Compliant)	Pkg. Dwg. #
ISL80410IBEZ	80410 IBEZ	-40 to +125	Yes	ADJ	-	8 Ld EPSON	M8.15B
ISL80410IBEZ-T	80410 IBEZ	-40 to +125	Yes	ADJ	2.5k	8 Ld EPSON	M8.15B
ISL80410IBEZ-T7A	80410 IBEZ	-40 to +125	Yes	ADJ	250	8 Ld EPSON	M8.15B
ISL80410EVAL1Z	Evaluation Platform						

Notes:

- See [TB347](#) for details about reel specifications.
- These Pb-free plastic packaged products employ special Pb-free material sets, molding compounds/die attach materials, and 100% matte tin plate plus anneal (e3 termination finish, which is RoHS compliant and compatible with both SnPb and Pb-free soldering operations). Pb-free products are MSL classified at Pb-free peak reflow temperatures that meet or exceed the Pb-free requirements of IPC/JEDEC J STD-020.
- For Moisture Sensitivity Level (MSL), see the [ISL80410](#) device page. For more information about MSL, see [TB363](#).

Table 1. Key Differences in Family of 40V LDO Parts

Part Number	Minimum I _{OUT}	IC Package
ISL80410	150mA	8 Ld EPSON
ISL80136	50mA	8 Ld EPSON
ISL80138	150mA	14 LD HTSSOP

1.3 Pin Configuration

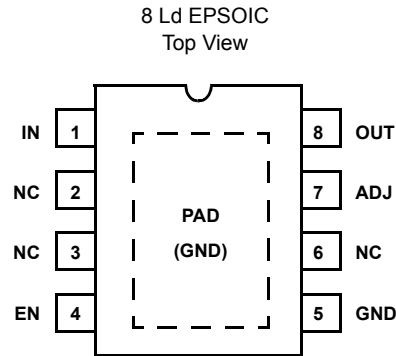

1.4 Pin Descriptions

Pin Number	Pin Name	Description
1	IN	Input voltage pin. A minimum 0.1 μ F X5R/X7R capacitor is required for proper operation. Range: 6V to 40V
2, 3, 6	NC	These pins have internal termination and can be left unconnected. Connection to ground is optional.
4	EN	Set this pin high to enable the device. Range: 0V to V_{IN}
5	GND	Ground pin.
7	ADJ	This pin is connected to the external feedback resistor divider, which sets the LDO output voltage.
8	OUT	Regulated output voltage. A 10 μ F X5R/X7R output capacitor is required for stability. Range: 0V to 12V
-	PAD	It is recommended to solder the PAD to the ground plane.

2. Specifications

2.1 Absolute Maximum Ratings

Parameter	Minimum	Maximum	Unit
IN Pin to GND Voltage	GND - 0.3	45	V
OUT Pin to GND Voltage	GND - 0.3	16	V
ADJ Pin to GND Voltage	GND - 0.3	3	V
EN Pin to GND Voltage	GND - 0.3	VIN	V
Output Short-Circuit Duration	Indefinite		-
ESD Rating	Value		Unit
Human Body Model (Tested per JESD22-A114E)		5	kV
Machine Model (Tested per JESD-A115-A)		200	V
Charge Device Model (Tested per JESD22-C101C)		2.2	kV
Latch-up (Tested per JESD78B; Class II, Level A)		100	mA

CAUTION: Do not operate at or near the maximum ratings listed for extended periods of time. Exposure to such conditions can adversely impact product reliability and result in failures not covered by warranty.

2.2 Thermal Information

Thermal Resistance (Typical)	θ_{JA} (°C/W)	θ_{JC} (°C/W)
8 Ld EPSON Package (Notes 4, 5)	50	9

Notes:

- θ_{JA} is measured in free air with the component mounted on a high-effective thermal conductivity test board with “direct attach” features. See [TB379](#) for more information.
- For θ_{JC} , the “case temp” location is the center of the exposed metal pad on the package underside.

Parameter	Minimum	Maximum	Unit
Maximum Junction Temperature		+150	°C
Maximum Storage Temperature Range	-65	+175	°C
Pb-Free Reflow Profile	See TB493		

2.3 Recommended Operating Conditions

Parameter	Minimum	Maximum	Unit
Ambient Temperature Range	-40	+125	°C
IN pin to GND Voltage	+6	+40	V
OUT pin to GND Voltage	+2.5	12	V
EN pin to GND Voltage	0	40	V

2.4 Electrical Specifications

Recommended Operating Conditions, unless otherwise noted. $V_{IN} = 14V$, $I_{OUT} = 1mA$, $T_A = T_J = -40^{\circ}C$ to $+125^{\circ}C$, unless otherwise noted. Typical specifications are at $T_A = +25^{\circ}C$. **Boldface limits apply across the operating temperature range, $-40^{\circ}C$ to $+125^{\circ}C$.**

Parameter	Symbol	Test Conditions	Min (Note 8)	Typ	Max (Note 8)	Unit
Input Voltage Range	V_{IN}		6		40	V
Guaranteed Output Current	I_{OUT}	$V_{IN} = V_{OUT} + V_{DO}$	150			mA
ADJ Reference Voltage	V_{OUT}	EN = High, $V_{IN} = 14V$, $I_{OUT} = 0.1mA$ to $150mA$	1.211	1.223	1.235	V
Line Regulation	$(V_{OUT\ low\ line} - V_{OUT\ high\ line}) / V_{OUT\ low\ line}$	$6V < V_{IN} < 40V$, $I_{OUT} = 1mA$		0.04	0.15	%
Load Regulation	$(V_{OUT\ no\ load} - V_{OUT\ high\ load}) / V_{OUT\ no\ load}$	$V_{IN} = 14V$, $I_{OUT} = 100\mu A$ to $150mA$		0.3	0.6	%
Dropout Voltage (Note 6)	ΔV_{DO}	$I_{OUT} = 1mA$, $V_{OUT} = 2.5V$		7	33	mV
		$I_{OUT} = 150mA$, $V_{OUT} = 2.5V$		380	610	mV
		$I_{OUT} = 1mA$, $V_{OUT} = 5V$		7	33	mV
		$I_{OUT} = 150mA$, $V_{OUT} = 5V$		295	545	mV
Shutdown Current	I_{SHDN}	EN = LOW		2	3.64	μA
Quiescent Current	IQ	EN = HIGH, $I_{OUT} = 0mA$		18	24	μA
		EN = HIGH, $I_{OUT} = 1mA$		22	42	μA
		EN = HIGH, $I_{OUT} = 10mA$		34	60	μA
		EN = HIGH, $I_{OUT} = 150mA$		90	125	μA
Power Supply Rejection Ratio	PSRR	$f = 100Hz$; $V_{IN_RIPPLE} = 500mV_{P-P}$; Load = $150mA$		66		dB
Output Voltage Noise		$V_{IN} = 14V$, $V_{OUT} = 3.3V$, $C_{OUT} = 10\mu F$, $I_{OUT} = 10mA$, BW = $100Hz$ to $100kHz$		26		μV_{RMS}
EN Function						
EN Threshold Voltage	V_{EN_H}	$V_{OUT} = \text{Off to On}$			1.485	V
	V_{EN_L}	$V_{OUT} = \text{On to Off}$	0.975			V
EN Pin Current	I_{EN}	$V_{OUT} = 0V$		0.026		μA
EN to Regulation Time (Note 7)	t_{EN}			1.65	1.93	ms
Protection Features						
Output Current Limit	I_{LIMIT}	$V_{OUT} = 0V$	175	410		mA
Thermal Shutdown	T_{SHDN}	Junction Temperature Rising		+165		$^{\circ}C$
Thermal Shutdown Hysteresis	T_{HYST}			+20		$^{\circ}C$

Notes:

- Dropout voltage is defined as $(V_{IN} - V_{OUT})$ when V_{OUT} is 2% below the value of V_{OUT} .
- Enable to Regulation Time is the time the output takes to reach 95% of its final value with $V_{IN} = 14V$. EN is taken from V_{IL} to V_{IH} in 5ns. For the adjustable versions, the output voltage is set at 5V.
- Parameters with MIN and/or MAX limits are 100% tested at $+25^{\circ}C$, unless otherwise specified. Temperature limits established by characterization and are not production tested.

3. Typical Performance Curves

$V_{IN} = 14V$, $I_{OUT} = 1mA$, $V_{OUT} = 5V$, $T_J = +25^{\circ}C$, unless otherwise specified.

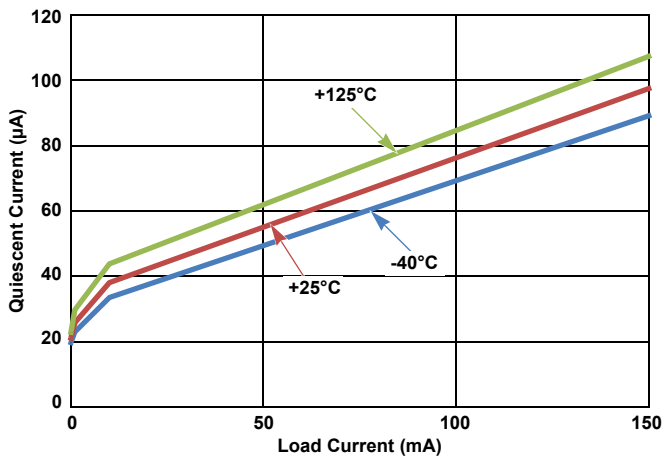

Figure 4. Quiescent Current vs Load Current

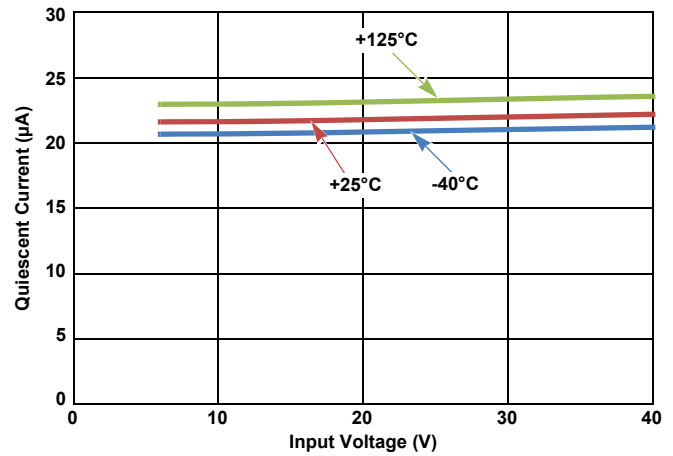

Figure 5. Quiescent Current vs Input Voltage (No Load)

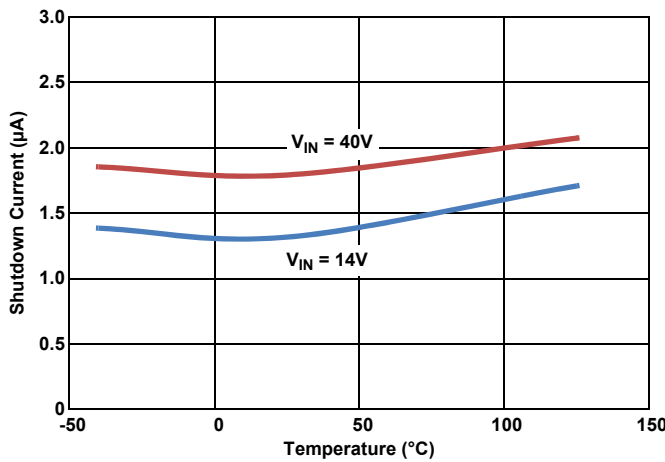

Figure 6. Shutdown Current vs Temperature (EN = 0)

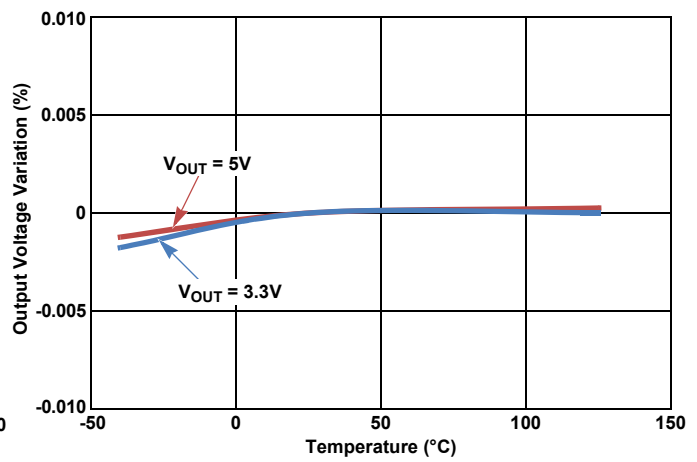

Figure 7. Output Voltage vs Temperature (Load = 50mA)

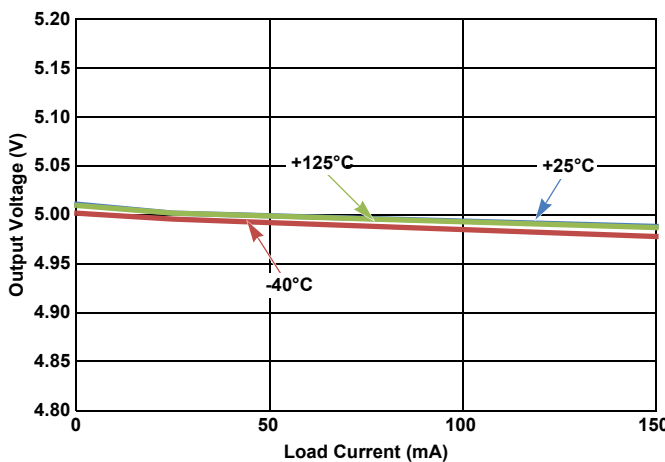

Figure 8. Output Voltage vs Load Current

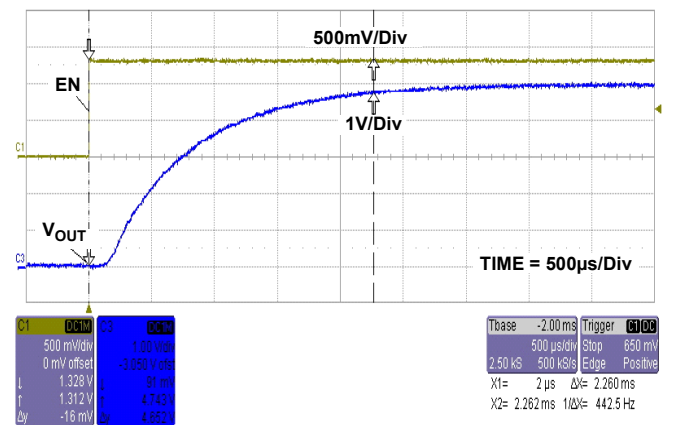

Figure 9. Start-Up Waveform

$V_{IN} = 14V$, $I_{OUT} = 1mA$, $V_{OUT} = 5V$, $T_J = +25^{\circ}C$, unless otherwise specified. (Continued)

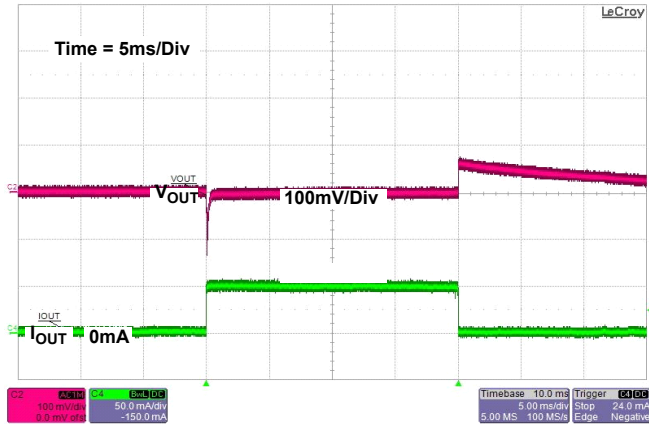

Figure 10. Load Transient Response

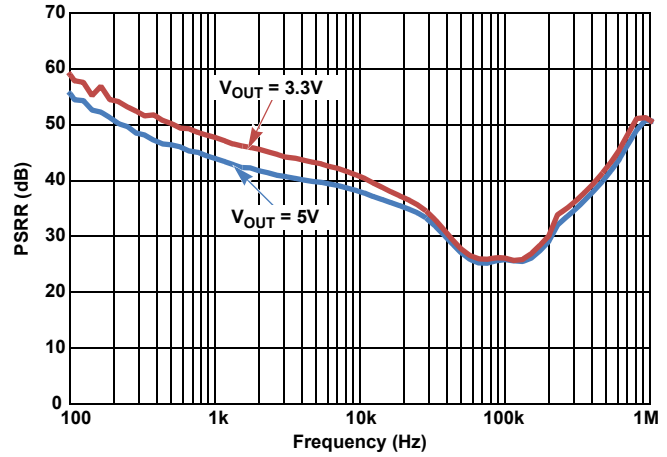

Figure 11. PSRR vs Frequency for Various Output Voltages, (Load = 150mA)

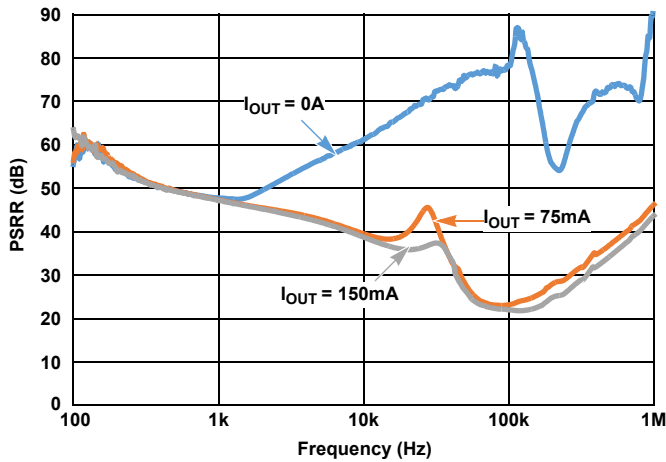

Figure 12. PSRR vs Frequency for Various Load Currents, $V_{OUT} = 3.3V$

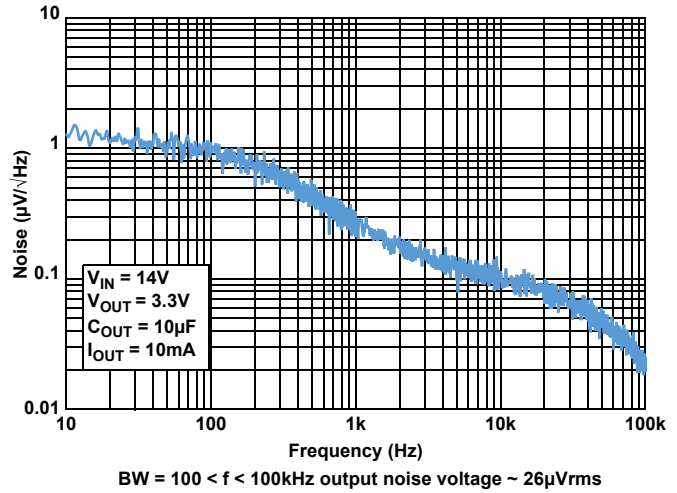

Figure 13. Output Noise Spectral Density, $I_{OUT} = 10mA$

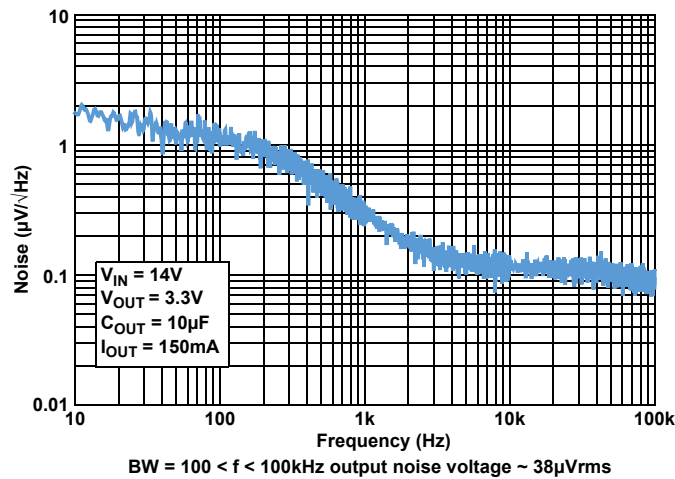

Figure 14. Output Noise Spectral Density, $I_{OUT} = 150mA$

4. Functional Description

4.1 Functional Overview

The ISL80410 is a high performance, high voltage, Low-Dropout regulator (LDO) with 150mA sourcing capability. The part is rated to operate across the -40°C to +125°C temperature range. Its ultra low quiescent current makes it an ideal choice for “always-on” applications. It works well under a “load dump condition” in which the input voltage could rise up to 40V. This LDO device also features current limit and thermal shutdown protection.

4.2 Enable Control

The ISL80410 has an enable pin, which turns the device on when pulled high. When EN is low, the IC goes into shutdown mode and draws less than 2μA of current. Tie the EN pin directly to IN for “always-on” operation.

4.3 Current Limit Protection

The ISL80410 has internal current limiting functionality to protect the regulator during fault conditions. During current limit, the output sources a fixed amount of current largely independent of the output voltage. If the short or overload is removed from V_{OUT} , the output returns to normal voltage regulation mode.

4.4 Thermal Fault Protection

If the die temperature exceeds a typical value of +165°C, the output of the LDO shuts down until the die temperature cools to a typical value of +145°C. The level of power dissipated, combined with the ambient temperature and the thermal impedance of the package, determines if the junction temperature exceeds the thermal shutdown temperature. See [“Power Dissipation” on page 9](#) for more details.

5. Application Information

5.1 Input and Output Capacitors

A minimum 0.1µF ceramic capacitor is recommended at the input for proper operation. For the output, a ceramic capacitor with a capacitance of 10µF is recommended for the ISL80410 to maintain stability. Route the ground connection of the output capacitor directly to the GND pin of the device and place it close to the IC.

5.2 Output Voltage Setting

The ISL80410 output voltage is programmed using an external resistor divider as shown in [Figure 15](#).

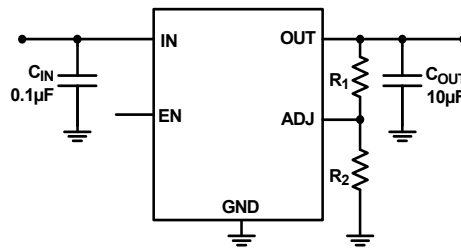

Figure 15. Output Voltage Setting

The output voltage is calculated using [Equation 1](#):

$$(EQ. 1) \quad V_{OUT} = 1.223V \times \left(\frac{R_1}{R_2} + 1 \right)$$

5.3 Power Dissipation

The junction temperature must not exceed the range specified in [“Recommended Operating Conditions” on page 4](#). The power dissipation can be calculated using [Equation 2](#):

$$(EQ. 2) \quad P_D = (V_{IN} - V_{OUT}) \times I_{OUT} + V_{IN} \times I_{GND}$$

The maximum allowable junction temperature, $T_{J(MAX)}$, and the maximum expected ambient temperature, $T_{A(MAX)}$, determine the maximum allowable junction temperature rise (ΔT_J), as shown in [Equation 3](#):

$$(EQ. 3) \quad \Delta T_J = T_{J(MAX)} - T_{A(MAX)}$$

To calculate the maximum ambient operating temperature, use the junction-to-ambient thermal resistance (θ_{JA}) as shown in [Equation 4](#):

$$(EQ. 4) \quad T_{J(MAX)} = P_{D(MAX)} \times \theta_{JA} + T_A$$

5.4 Board Layout Recommendations

A good Printed Circuit Board (PCB) layout is important to achieve expected performance. When placing the components and routing the trace, minimize the ground impedance and keep the parasitic inductance low. The input and output capacitors should have a good ground connection and be placed as close to the IC as possible. The feedback trace in the adjustable version should be away from other noisy traces. Connect the exposed pad to the ground plane using as many vias as possible within the pad for the best thermal relief.

6. Revision History

Rev.	Date	Description
2.00	Aug 8, 2019	Updated POD to the latest revision. Changes are as follows: -Updated L Millimeter minimum in detail A from 0.41 to 0.406. -Updated the following in the Side View: -Changed total package height Millimeter MIN and MAX values from: 1.43 MIN and 1.68 MAX to: 1.422 MIN and 1.700 MAX and Inches max from 0.066 to 0.067. -Changed A1 Inches MIN from: 0.001 to 0.0, and A1 Millimeters MIN from 0.03 to 0.0
1.00	Feb 8, 2019	Updated title Updated the 6th bullet and added the 8th bullet in the features list. Updated Related Literature section. Updated ordering information table with tape and reel information and updated notes. Added Output Voltage Noise specification.
0.00	Jan 24, 2018	Initial release.

7. Package Outline Drawing

For the most recent package outline drawing, see [M8.15B](#).

M8.15B
 8 Lead Narrow Body Small Outline Exposed Pad Plastic Package
 Rev 7, 5/19

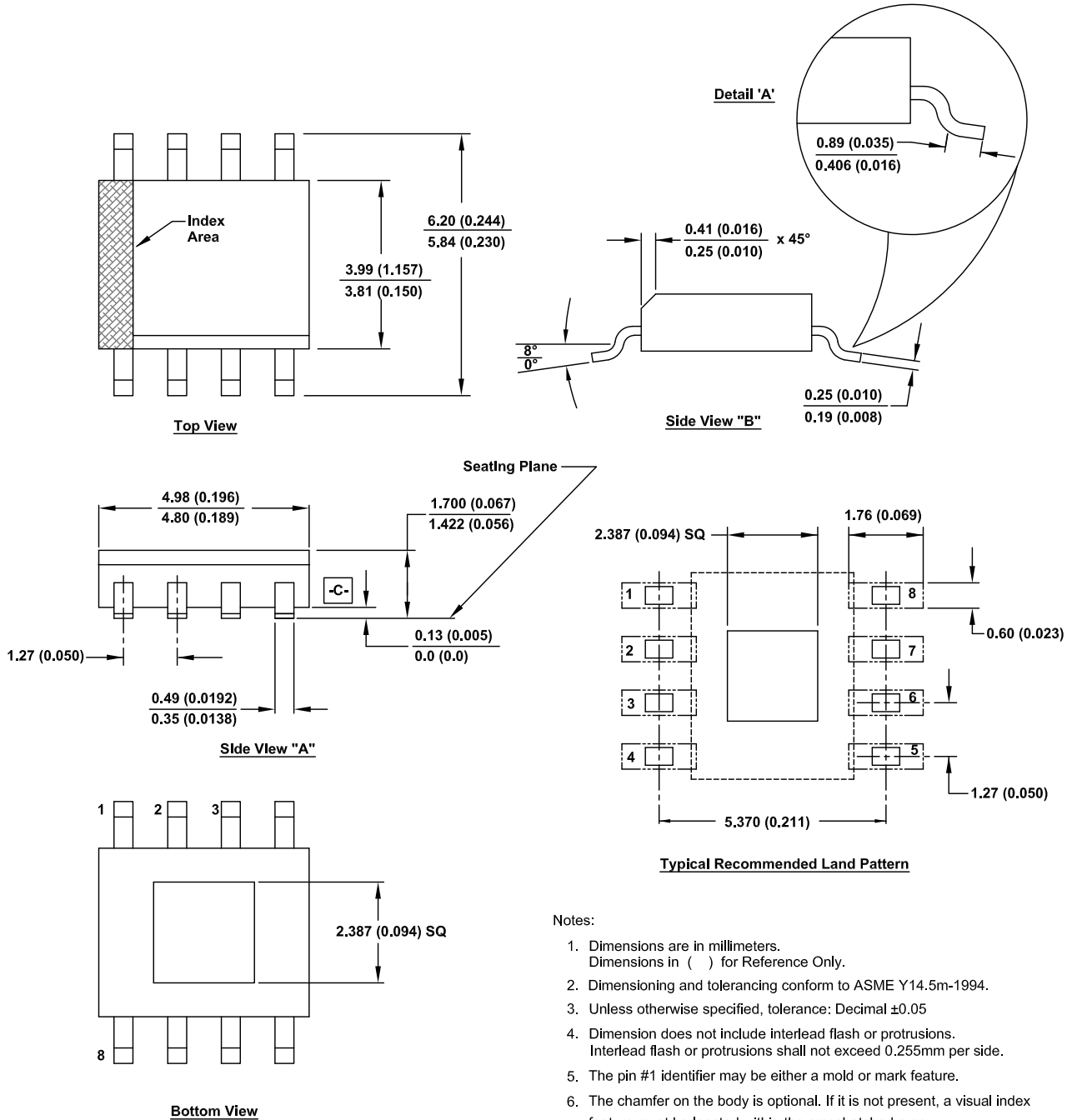

- Notes:
1. Dimensions are in millimeters. Dimensions in () for Reference Only.
 2. Dimensioning and tolerancing conform to ASME Y14.5m-1994.
 3. Unless otherwise specified, tolerance: Decimal ±0.05
 4. Dimension does not include interlead flash or protrusions. Interlead flash or protrusions shall not exceed 0.255mm per side.
 5. The pin #1 identifier may be either a mold or mark feature.
 6. The chamfer on the body is optional. If it is not present, a visual index feature must be located within the crosshatched area.

Notice

1. Descriptions of circuits, software and other related information in this document are provided only to illustrate the operation of semiconductor products and application examples. You are fully responsible for the incorporation or any other use of the circuits, software, and information in the design of your product or system. Renesas Electronics disclaims any and all liability for any losses and damages incurred by you or third parties arising from the use of these circuits, software, or information.
 2. Renesas Electronics hereby expressly disclaims any warranties against and liability for infringement or any other claims involving patents, copyrights, or other intellectual property rights of third parties, by or arising from the use of Renesas Electronics products or technical information described in this document, including but not limited to, the product data, drawings, charts, programs, algorithms, and application examples.
 3. No license, express, implied or otherwise, is granted hereby under any patents, copyrights or other intellectual property rights of Renesas Electronics or others.
 4. You shall not alter, modify, copy, or reverse engineer any Renesas Electronics product, whether in whole or in part. Renesas Electronics disclaims any and all liability for any losses or damages incurred by you or third parties arising from such alteration, modification, copying or reverse engineering.
 5. Renesas Electronics products are classified according to the following two quality grades: "Standard" and "High Quality". The intended applications for each Renesas Electronics product depends on the product's quality grade, as indicated below.
 - "Standard": Computers; office equipment; communications equipment; test and measurement equipment; audio and visual equipment; home electronic appliances; machine tools; personal electronic equipment; industrial robots; etc.
 - "High Quality": Transportation equipment (automobiles, trains, ships, etc.); traffic control (traffic lights); large-scale communication equipment; key financial terminal systems; safety control equipment; etc.Unless expressly designated as a high reliability product or a product for harsh environments in a Renesas Electronics data sheet or other Renesas Electronics document, Renesas Electronics products are not intended or authorized for use in products or systems that may pose a direct threat to human life or bodily injury (artificial life support devices or systems; surgical implantations; etc.), or may cause serious property damage (space system; undersea repeaters; nuclear power control systems; aircraft control systems; key plant systems; military equipment; etc.). Renesas Electronics disclaims any and all liability for any damages or losses incurred by you or any third parties arising from the use of any Renesas Electronics product that is inconsistent with any Renesas Electronics data sheet, user's manual or other Renesas Electronics document.
 6. When using Renesas Electronics products, refer to the latest product information (data sheets, user's manuals, application notes, "General Notes for Handling and Using Semiconductor Devices" in the reliability handbook, etc.), and ensure that usage conditions are within the ranges specified by Renesas Electronics with respect to maximum ratings, operating power supply voltage range, heat dissipation characteristics, installation, etc. Renesas Electronics disclaims any and all liability for any malfunctions, failure or accident arising out of the use of Renesas Electronics products outside of such specified ranges.
 7. Although Renesas Electronics endeavors to improve the quality and reliability of Renesas Electronics products, semiconductor products have specific characteristics, such as the occurrence of failure at a certain rate and malfunctions under certain use conditions. Unless designated as a high reliability product or a product for harsh environments in a Renesas Electronics data sheet or other Renesas Electronics document, Renesas Electronics products are not subject to radiation resistance design. You are responsible for implementing safety measures to guard against the possibility of bodily injury, injury or damage caused by fire, and/or danger to the public in the event of a failure or malfunction of Renesas Electronics products, such as safety design for hardware and software, including but not limited to redundancy, fire control and malfunction prevention, appropriate treatment for aging degradation or any other appropriate measures. Because the evaluation of microcomputer software alone is very difficult and impractical, you are responsible for evaluating the safety of the final products or systems manufactured by you.
 8. Please contact a Renesas Electronics sales office for details as to environmental matters such as the environmental compatibility of each Renesas Electronics product. You are responsible for carefully and sufficiently investigating applicable laws and regulations that regulate the inclusion or use of controlled substances, including without limitation, the EU RoHS Directive, and using Renesas Electronics products in compliance with all these applicable laws and regulations. Renesas Electronics disclaims any and all liability for damages or losses occurring as a result of your noncompliance with applicable laws and regulations.
 9. Renesas Electronics products and technologies shall not be used for or incorporated into any products or systems whose manufacture, use, or sale is prohibited under any applicable domestic or foreign laws or regulations. You shall comply with any applicable export control laws and regulations promulgated and administered by the governments of any countries asserting jurisdiction over the parties or transactions.
 10. It is the responsibility of the buyer or distributor of Renesas Electronics products, or any other party who distributes, disposes of, or otherwise sells or transfers the product to a third party, to notify such third party in advance of the contents and conditions set forth in this document.
 11. This document shall not be reprinted, reproduced or duplicated in any form, in whole or in part, without prior written consent of Renesas Electronics.
 12. Please contact a Renesas Electronics sales office if you have any questions regarding the information contained in this document or Renesas Electronics products.
- (Note1) "Renesas Electronics" as used in this document means Renesas Electronics Corporation and also includes its directly or indirectly controlled subsidiaries.
- (Note2) "Renesas Electronics product(s)" means any product developed or manufactured by or for Renesas Electronics.

(Rev.4.0-1 November 2017)

Corporate Headquarters

TOYOSU FORESIA, 3-2-24 Toyosu,
Koto-ku, Tokyo 135-0061, Japan
www.renesas.com

Contact Information

For further information on a product, technology, the most up-to-date version of a document, or your nearest sales office, please visit:
www.renesas.com/contact/

Trademarks

Renesas and the Renesas logo are trademarks of Renesas Electronics Corporation. All trademarks and registered trademarks are the property of their respective owners.