

## Description

The 3400L uses advanced trench technology to provide excellent  $R_{DS(ON)}$ , low gate charge and operation with gate voltages as low as 2.5V. This device is suitable for use as a Battery protection or in other Switching application.

## General Features

$V_{DSS}$	$R_{DS(ON)}$ @ 10V (Typ.)	$R_{DS(ON)}$ @ 4.5V (Typ.)	$R_{DS(ON)}$ @ 2.5V (Typ.)	$I_D$
30V	18 m $\Omega$	21 m $\Omega$	38 m $\Omega$	5.6A

- High power and current handling capability
- Surface mount package
- RoHS Compliant

## Application

- PWM applications
- Load switch
- Power management

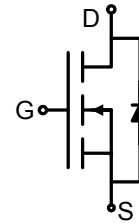

Schematic diagram

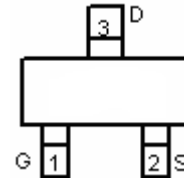

Marking and pin assignment



SOT-23-3L

## Ordering Information

Part Number	Marking	Case	Packaging
3400L	3400L	SOT-23-3L	3000pcs/Reel

## Absolute Maximum Ratings ( $T_A=25^\circ\text{C}$ unless otherwise noted)

Parameter	Symbol	Limit	Unit
Drain-Source Voltage	$V_{DS}$	30	V
Gate-Source Voltage	$V_{GS}$	$\pm 12$	V
Drain Current-Continuous	$I_D$	5.6	A
Drain Current-Pulsed <sup>(Note 1)</sup>	$I_{DM}$	30	A
Maximum Power Dissipation	$P_D$	1.4	W
Operating Junction and Storage Temperature Range	$T_J, T_{STG}$	-55 To 150	$^\circ\text{C}$

## Thermal Characteristic

Thermal Resistance, Junction-to-Ambient <sup>(Note 2)</sup>	$R_{\theta JA}$	89	$^\circ\text{C/W}$
---	-----------------	----	--------------------

## Electrical Characteristics ( $T_A=25^\circ\text{C}$ unless otherwise noted)

Parameter	Symbol	Condition	Min	Typ	Max	Unit
<b>Off Characteristics</b>						
Drain-Source Breakdown Voltage	$BV_{DSS}$	$V_{GS}=0V, I_D=250\mu A$	30	-	-	V
Zero Gate Voltage Drain Current	$I_{DSS}$	$V_{DS}=30V, V_{GS}=0V$	-	-	0.3	$\mu A$

Gate-Body Leakage Current	$I_{GSS}$	$V_{GS}=\pm 12V, V_{DS}=0V$	-	-	$\pm 100$	nA
<b>On Characteristics</b> <sup>(Note 3)</sup>						
Gate Threshold Voltage	$V_{GS(th)}$	$V_{DS}=V_{GS}, I_D=250\mu A$	0.7	1.15	1.4	V
Drain-Source On-State Resistance	$R_{DS(ON)}$	$V_{GS}=2.5V, I_D=2.8A$	-	38	59	m $\Omega$
		$V_{GS}=4.5V, I_D=2.8A$	-	21	33	m $\Omega$
		$V_{GS}=10V, I_D=2.8A$	-	18	27	m $\Omega$
Forward Transconductance	$g_{FS}$	$V_{DS}=5V, I_D=5A$	10	-	-	S
<b>Dynamic Characteristics</b> <sup>(Note4)</sup>						
Input Capacitance	$C_{ISS}$	$V_{DS}=15V, V_{GS}=0V,$ $F=1.0MHz$	-	820	-	PF
Output Capacitance	$C_{OSS}$		-	99	-	PF
Reverse Transfer Capacitance	$C_{RSS}$		-	77	-	PF
<b>Switching Characteristics</b> <sup>(Note 4)</sup>						
Turn-on Delay Time	$t_{d(on)}$	$V_{DD}=15V, R_L=2.7\Omega$ $V_{GS}=10V, R_{GEN}=3\Omega$	-	3.3	-	nS
Turn-on Rise Time	$t_r$		-	4.8	-	nS
Turn-Off Delay Time	$t_{d(off)}$		-	26	-	nS
Turn-Off Fall Time	$t_f$		-	4	-	nS
Total Gate Charge	$Q_g$	$V_{DS}=15V, I_D=5.6A,$ $V_{GS}=4.5V$	-	9.5	-	nC
Gate-Source Charge	$Q_{gs}$		-	1.5	-	nC
Gate-Drain Charge	$Q_{gd}$		-	3	-	nC
<b>Drain-Source Diode Characteristics</b>						
Diode Forward Voltage <sup>(Note 3)</sup>	$V_{SD}$	$V_{GS}=0V, I_S=2A$	-	-	1	V
Diode Forward Current <sup>(Note 2)</sup>	$I_S$		-	-	5.6	A

### Notes:

1. Repetitive Rating: Pulse width limited by maximum junction temperature.
2. Surface Mounted on FR4 Board,  $t \leq 10$  sec.
3. Pulse Test: Pulse Width  $\leq 300\mu s$ , Duty Cycle  $\leq 2\%$ .
4. Guaranteed by design, not subject to production

Typical Electrical and Thermal Characteristics

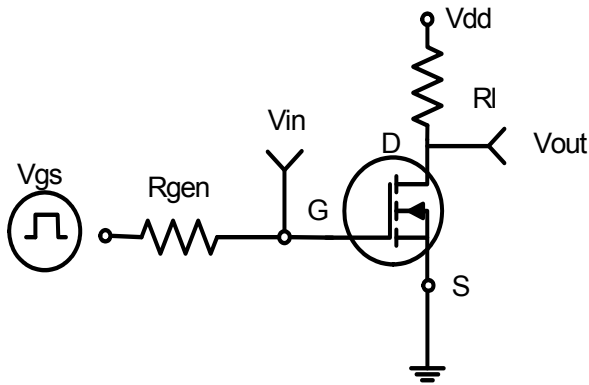

Figure 1: Switching Test Circuit

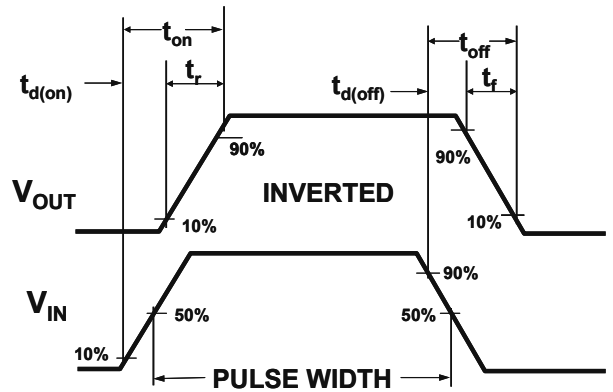

Figure 2: Switching Waveforms

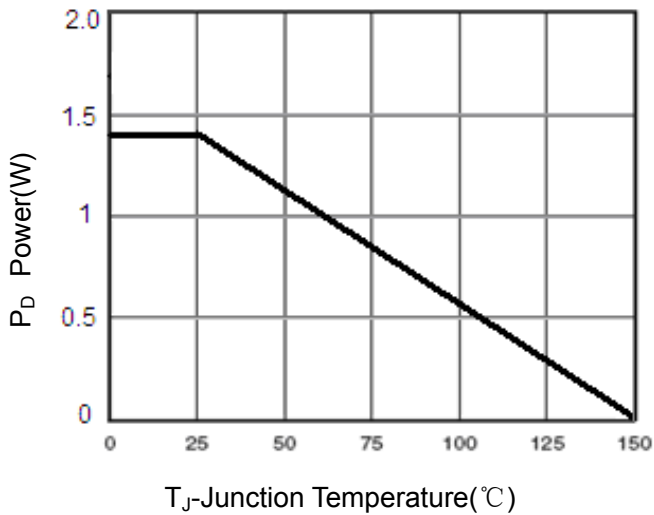

Figure 3 Power Dissipation

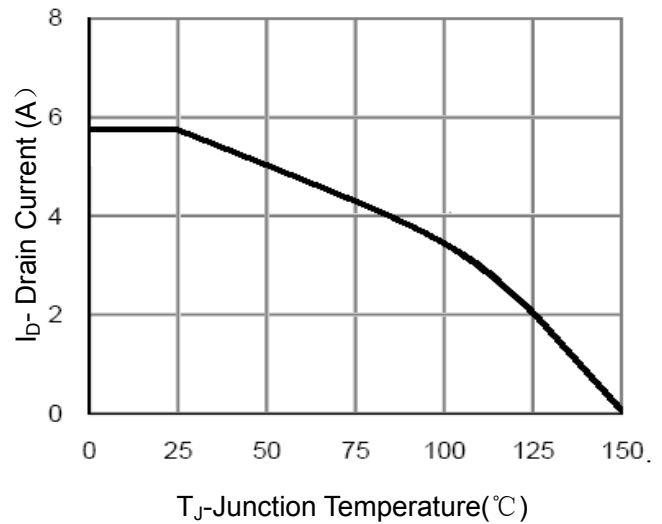

Figure 4 Drain Current

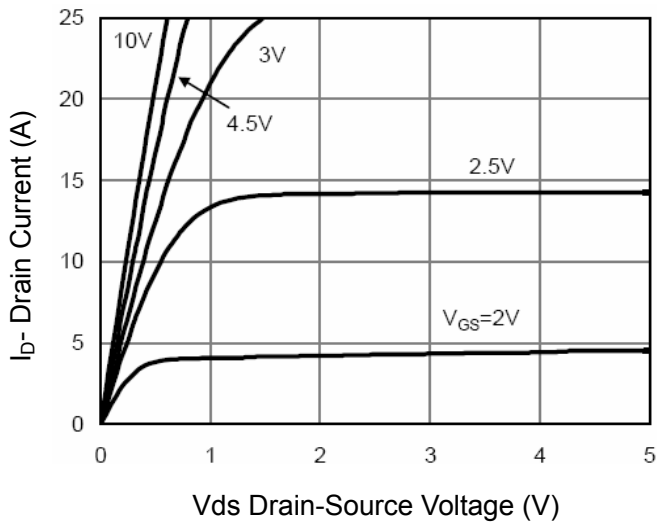

Figure 5 Output Characteristics

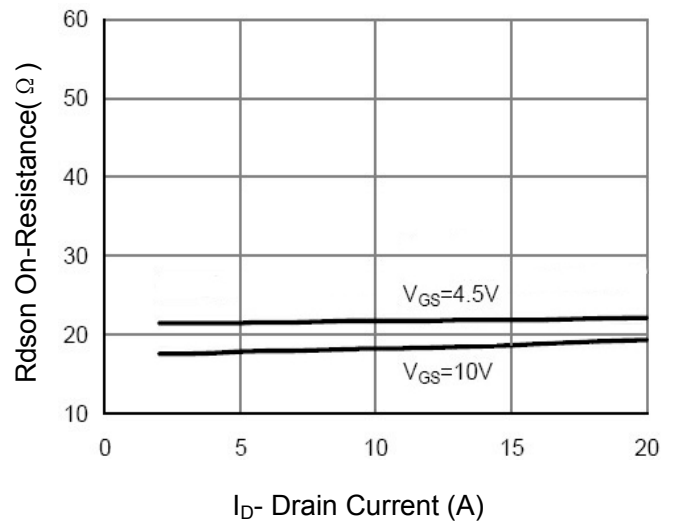
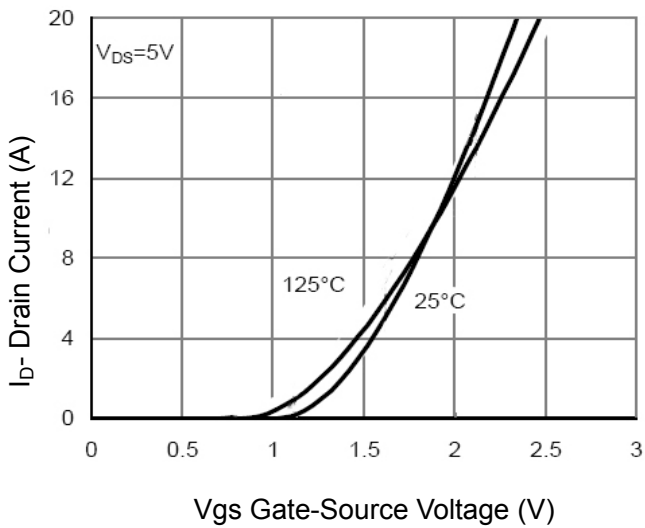
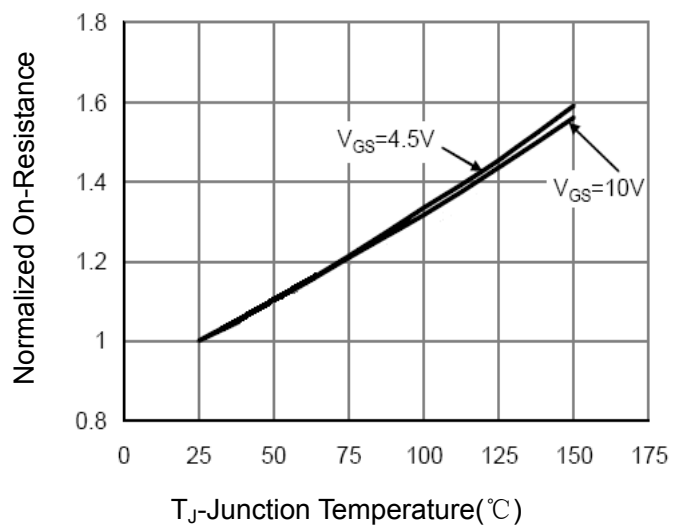

Figure 6 Drain-Source On-Resistance



**Figure 7 Transfer Characteristics**



**Figure 8 Drain-Source On-Resistance**

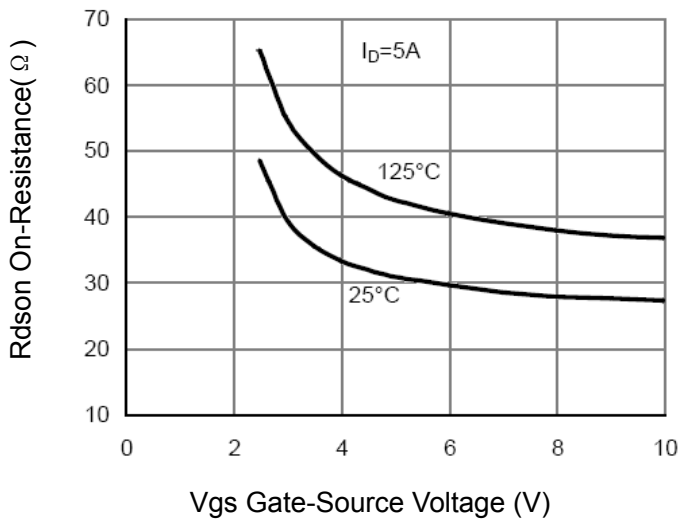

**Figure 9 Rdson vs Vgs**

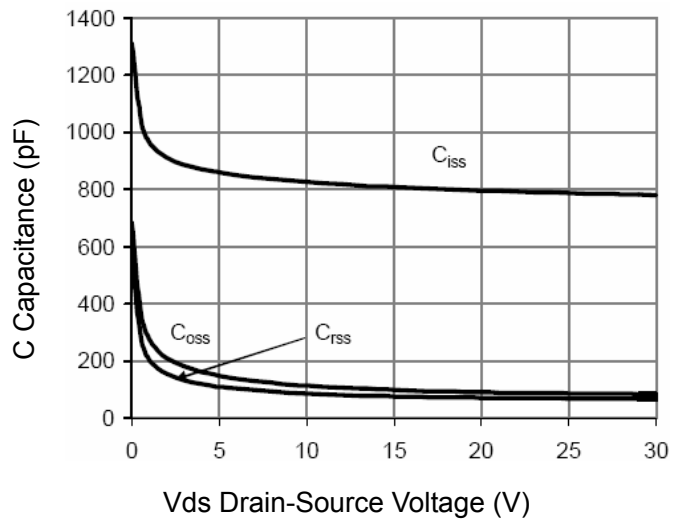

**Figure 10 Capacitance vs Vds**

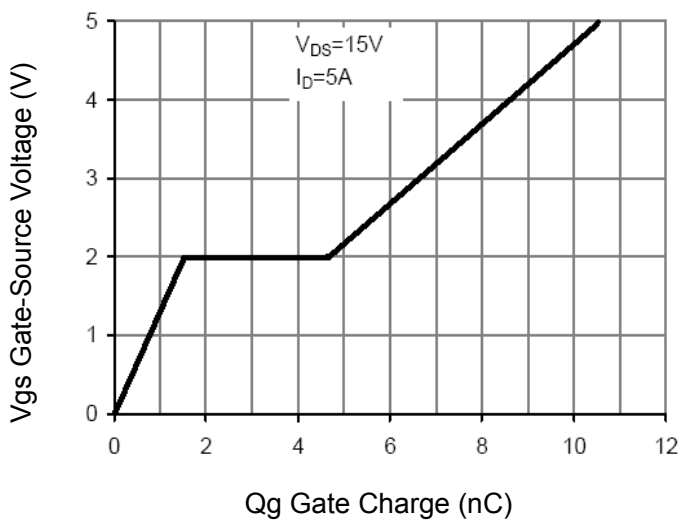

**Figure 11 Gate Charge**

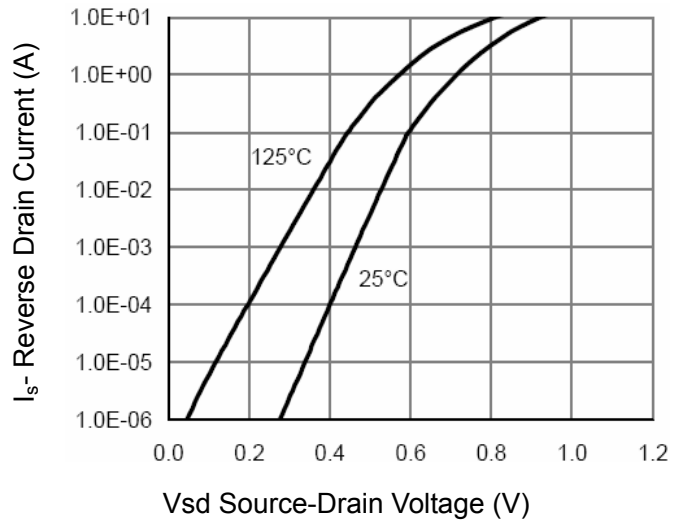

**Figure 12 Source- Drain Diode Forward**

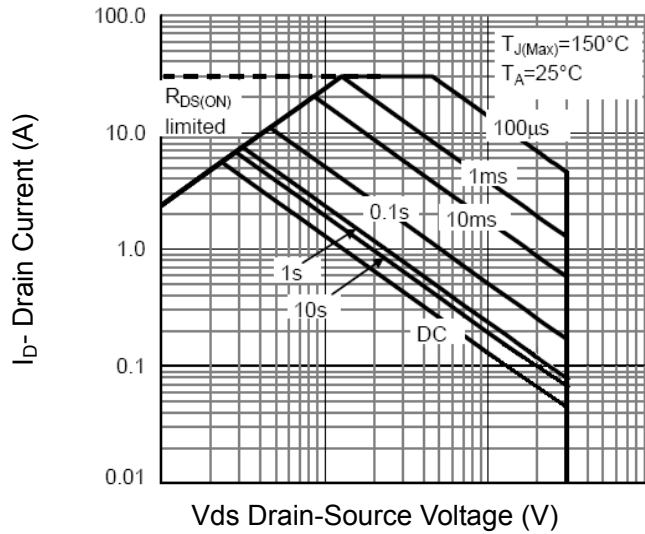

Figure 13 Safe Operation Area

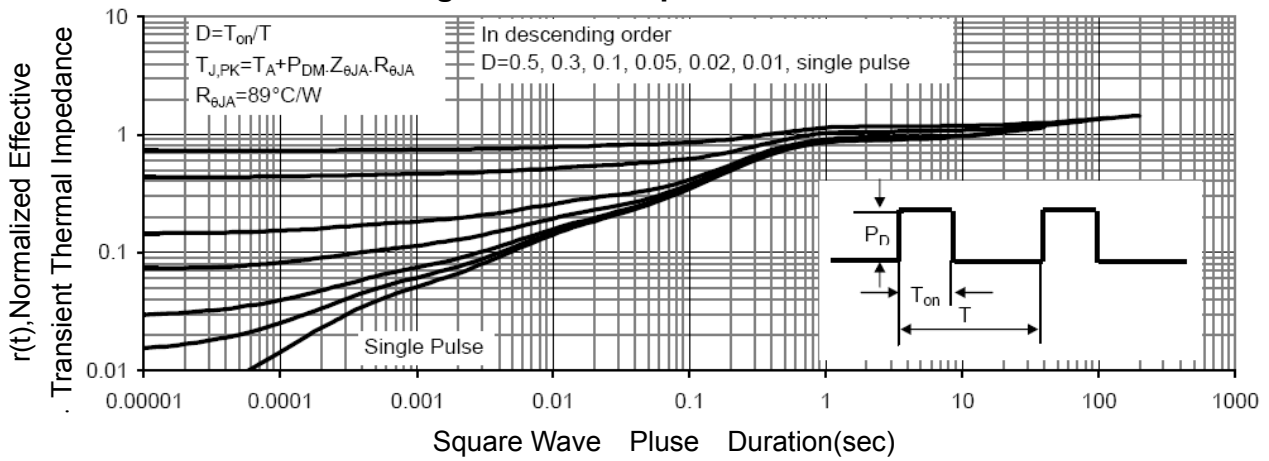
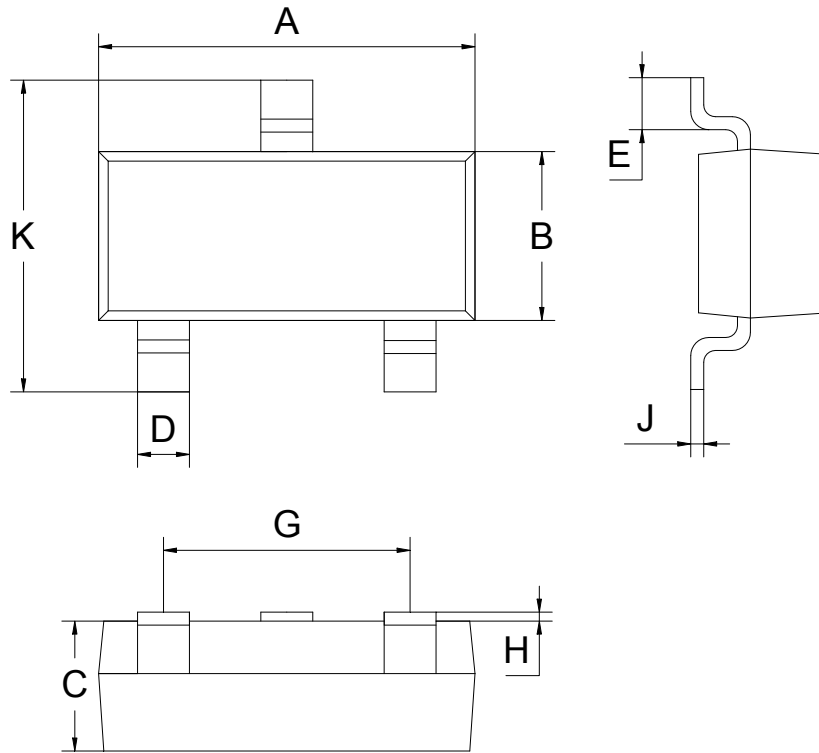

Figure 14 Normalized Maximum Transient Thermal Impedance

**SOT-23-3L Package information**



SOT-23-3L			
Dim	MIN	NOM	MAX
A	2.80	2.90	3.00
B	1.50	1.60	1.70
C	1.00	1.10	1.20
D	0.30	0.40	0.50
E	0.25	0.40	0.55
G	1.90		
H	0.00	-	0.10
J	0.047	0.127	0.207
K	2.60	2.80	3.00
All Dimensions in mm			