

SMAG Plastic-Encapsulate Diodes

1SMA59 SERIES Zener Diodes

Features

- P_{tot} 1.5W
- V_z 3.3V- 68V
- The marking bar indicates the cathode

Applications

- Stabilizing Voltage

Marking

- 1SMA59XXA
XX : From 13 To 45

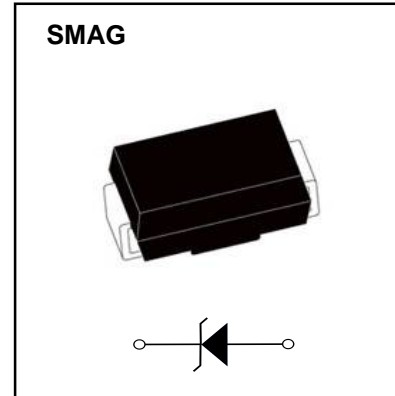

Limiting Values(Absolute Maximum Rating)

Item	Symbol	Unit	Conditions	Max
Power dissipation	P_d	W	$T_L=75^{\circ}\text{C}$	1.5
Zener current	I_z	mA		P_v / V_z
Operation Junction and Storage Temperature Range	T_J, T_{stg}	$^{\circ}\text{C}$		-55 ~ +150

Electrical Characteristics ($T_a=25^{\circ}\text{C}$ Unless otherwise specified)

Item	Symbol	Unit	Conditions	Max
Thermal resistance	$R_{\theta JA}$	$^{\circ}\text{C}/\text{W}$	Between junction to ambient	75
	$R_{\theta JL}$	$^{\circ}\text{C}/\text{W}$	Between junction to lead	30
Forward voltage	V_F	V	$I_F=200\text{mA}$	1.2

Electrical Characteristics ($T_A=25^{\circ}\text{C}$ unless otherwise noted)

Type	Zener voltage V_z (V)				Zener Impedance			Leakage Current		I_{zM} (mA) (dc)
	Min.	Mom.	Max.	@ I_{ZT} (mA)	Z_{ZT} @ I_{ZT} (Ω)	Z_{ZK} (Ω)	@ I_{ZK} (mA)	I_R (μA)	@ V_R (V)	
1SMA5913A	3.13	3.3	3.47	113.6	10	500	1.0	50	1.0	455
1SMA5914A	3.42	3.6	3.78	104.2	9.0	500	1.0	35.5	1.0	417
1SMA5915A	3.70	3.9	4.10	96.1	7.5	500	1.0	12.5	1.0	385
1SMA5916A	4.08	4.3	4.52	87.2	6.0	500	1.0	2.5	1.0	349
1SMA5917A	4.46	4.7	4.94	79.8	5.0	500	1.0	2.5	1.5	319
1SMA5918A	4.84	5.1	5.36	73.5	4.0	350	1.0	2.5	2.0	294
1SMA5919A	5.32	5.6	5.88	66.9	2.0	250	1.0	2.5	3.0	268
1SMA5920A	5.89	6.2	6.51	60.5	2.0	200	1.0	2.5	4.0	242
1SMA5921A	6.46	6.8	7.14	55.1	2.5	200	1.0	2.5	5.2	221
1SMA5922A	7.12	7.5	7.88	50	3.0	400	0.5	2.5	6.0	200
1SMA5923A	7.79	8.2	8.61	45.7	3.5	400	0.5	2.5	6.5	183
1SMA5924A	8.64	9.1	9.56	41.2	4.0	500	0.5	2.5	7.0	165
1SMA5925A	9.5	10	10.5	37.5	4.5	500	0.25	2.5	8.0	150
1SMA5926A	10.45	11	11.55	34.1	5.5	550	0.25	0.5	8.4	136
1SMA5927A	11.4	12	12.6	31.2	6.5	550	0.25	0.5	9.1	125
1SMA5928A	12.35	13	13.65	28.8	7.0	550	0.25	0.5	9.9	115
1SMA5929A	14.25	15	15.75	25	9.0	600	0.25	0.5	11.4	100
1SMA5930A	15.2	16	16.8	23.4	10	600	0.25	0.5	12.2	94
1SMA5931A	17.1	18	18.9	20.8	12	650	0.25	0.5	13.7	83
1SMA5932A	19	20	21	18.7	14	650	0.25	0.5	15.2	75
1SMA5933A	20.9	22	23.1	17	17.5	650	0.25	0.5	16.7	68
1SMA5934A	22.8	24	25.2	15.6	19	700	0.25	0.5	18.2	63
1SMA5935A	25.65	27	28.35	13.9	23	700	0.25	0.5	20.6	56
1SMA5936A	28.5	30	31.5	12.5	26	750	0.25	0.5	22.8	50
1SMA5937A	31.35	33	34.65	11.4	33	800	0.25	0.5	25.1	45
1SMA5938A	34.2	36	37.8	10.4	38	850	0.25	0.5	27.4	42
1SMA5939A	37.05	39	40.95	9.6	45	900	0.25	0.5	29.7	38
1SMA5940A	40.85	43	45.15	8.7	53	950	0.25	0.5	32.7	35
1SMA5941A	44.65	47	49.35	8.0	67	1000	0.25	0.5	35.8	32
1SMA5942A	48.45	51	53.55	7.3	70	1100	0.25	0.5	38.8	29
1SMA5943A	53.2	56	58.8	6.7	86	1300	0.25	0.5	42.6	27
1SMA5944A	58.9	62	65.1	6.0	100	1500	0.25	0.5	47.1	24
1SMA5945A	64.6	68	71.4	5.5	120	1700	0.25	0.5	51.7	22

Notes :

- (1) The type number listed have a standard tolerance on the nominal zener voltage of $\pm 5\%$
- (2) The reverse surge current is a non-repetitive, 8.3ms pulse width square wave or equivalent sine-wave superimposed on I_{ZT} per method.

Typical Characteristics

Fig. 1 - Power Temperature Derating Curve

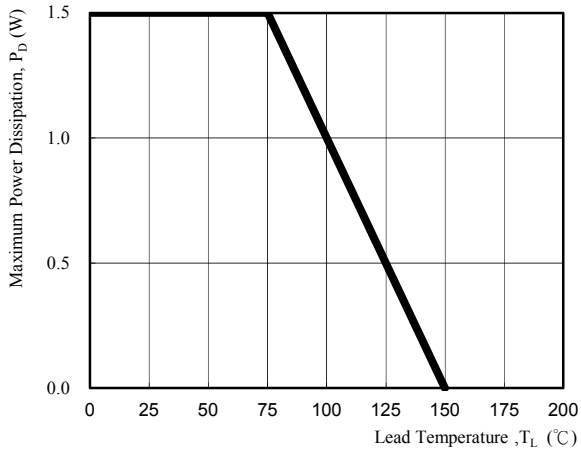

Fig. 2 - Temperature Coefficients v.s. Zener Voltage

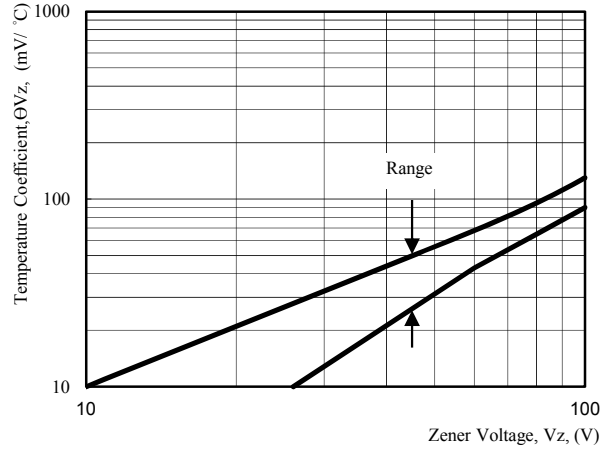

Fig. 3 - Typical Thermal Resistance v.s. Lead Length

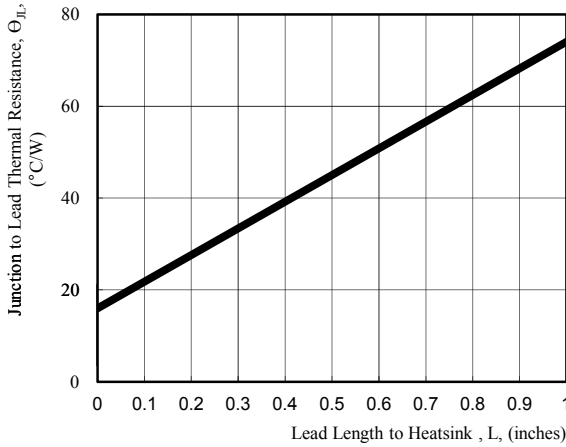

Fig. 4 - Maximum Surge Power

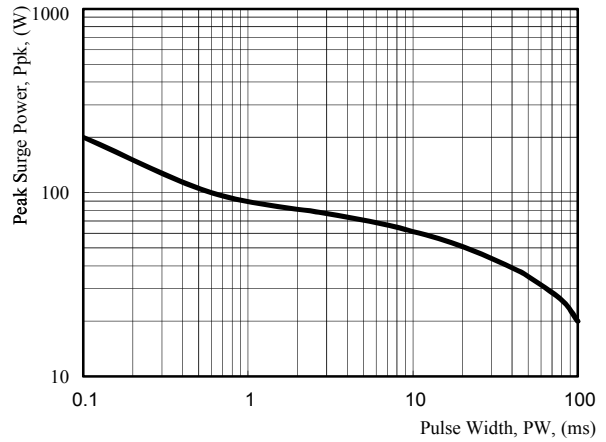
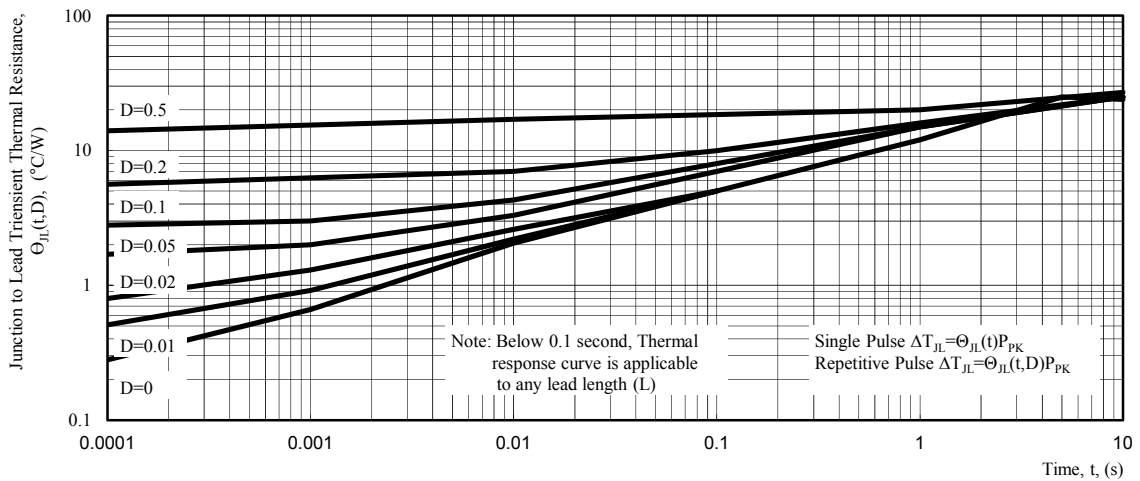
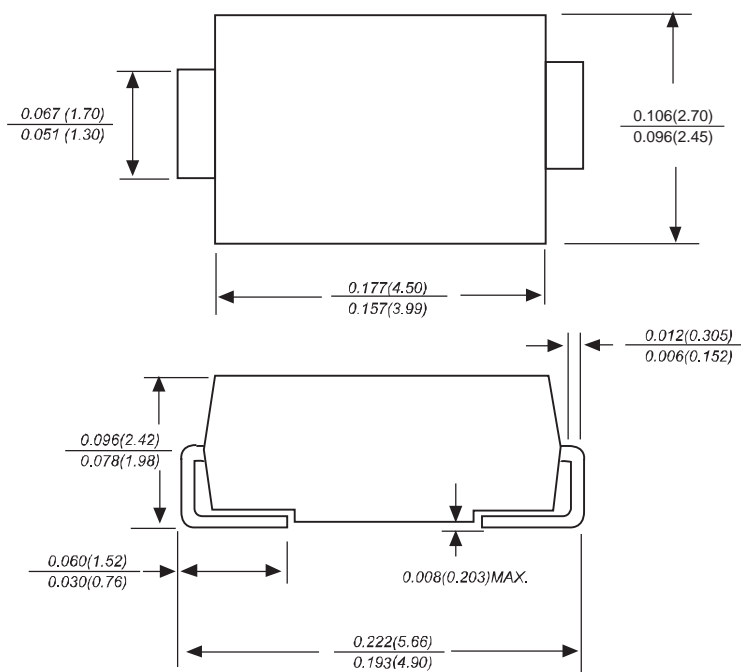

Fig. 5 - Typical Thermal Response L , Lead Length=3/8inch



SMAG Package Outline Dimensions



Dimensions in inches and (millimeters)

SMAG Suggested Pad Layout

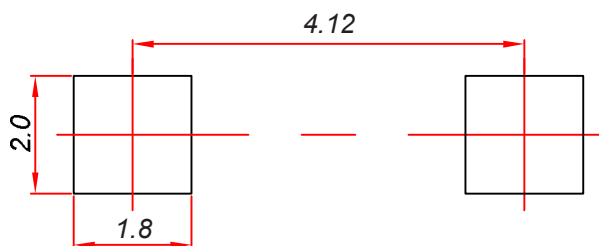

Note:

1. Controlling dimension: in millimeters.
2. General tolerance: ± 0.05 mm.
3. The pad layout is for reference purposes only.

NOTICE

JSCJ reserves the right to make modifications, enhancements, improvements, corrections or other changes without further notice to any product herein. JSCJ does not assume any liability arising out of the application or use of any product described herein.

Reel Taping Specifications For Surface Mount Devices- SMAG

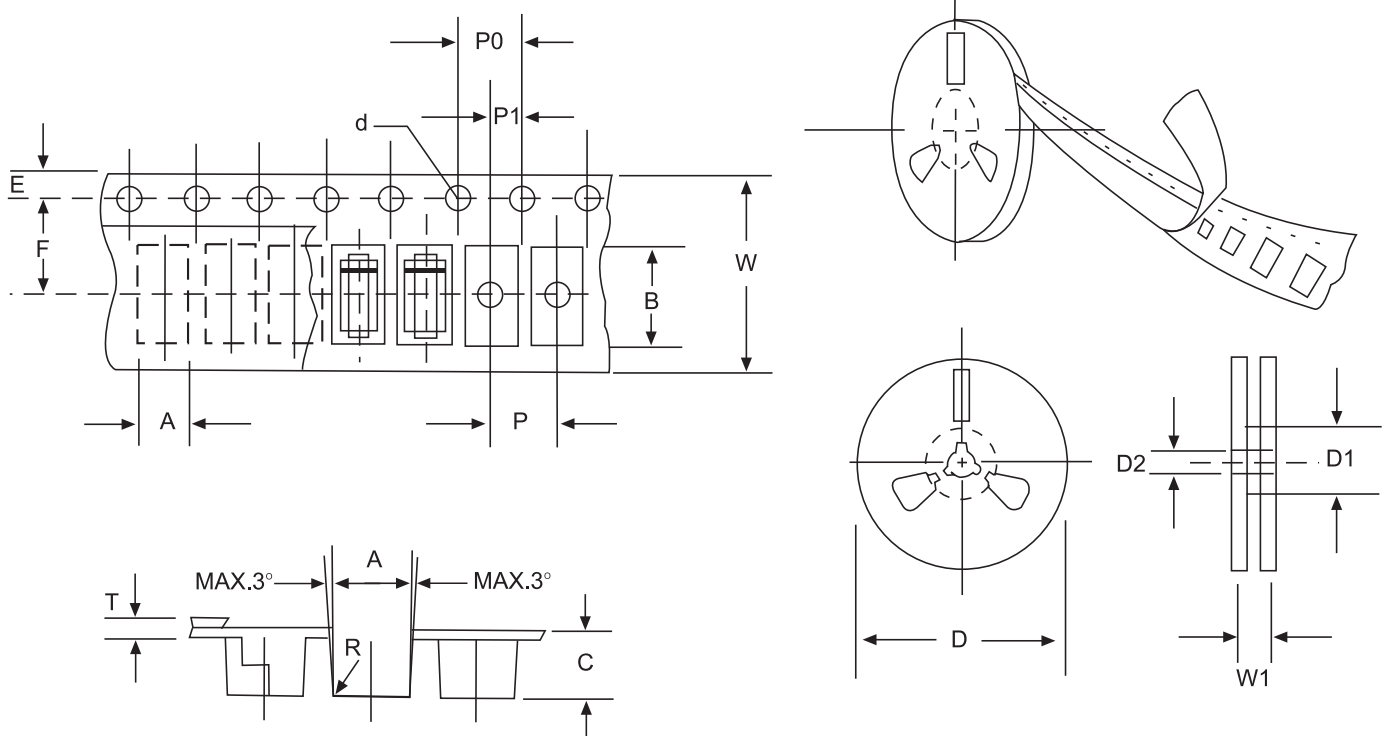

FIG: CONFIGURATION OF SURFACE MOUNTED DEVICES TAPING

ITEM	SYMBOL	SMAG mm(inch)
Carrier width	A	2.79±0.1(0.110±0.004)
Carrier length	B	5.33±0.1(0.210±0.004)
Carrier depth	C	2.36±0.1(0.093±0.004)
Sprocket hole	d	1.55±0.05(0.061±0.002)
Reel outside diameter	D	279±2.0 (11± 0.079)
Reel inner diameter	D1	75 ±1.0 (2.95 ±0.039)
Feed hole diameter	D2	13±0.5(0.512±0.020)
Sprocket hole position	E	1.75±0.1(0.069±0.004)
Punch hole position	F	5.5±0.05(0.217±0.002)
Punch hole pitch	P	4.0±0.1(0.157±0.004)
Sprocket hole pitch	P0	4.0±0.1(0.157±0.004)
Embossment center	P1	2.0±0.1(0.079±0.004)
Totall tape thickness	T	0.28±0.02(0.011 ±0.0008)
Tape width	W	12.0±0.2(0.472±0.008)
Reel width	W1	16.8±2.0(0.661±0.079)

NOTE: Devices are packed in accordance with EIA standard RS-481-A and specification given above.