

Product Summary

- $V_{drop} = 0.2V @ V_{in}=12V, I_L=3.0A, R_{DS(ON)}=55m\Omega$
- $V_{drop} = 0.2V @ V_{in}=5.0V, I_L=2.0A, R_{DS(ON)}=75m\Omega$
- Configuration Level-Shif

Application

- Battery Packs
- Battery-Powered Portable Equipment
- Cellular and Cordless Telephones

Package and Pin Configuration

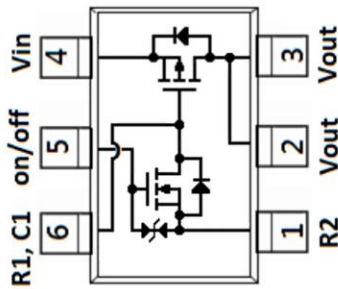

Circuit diagram

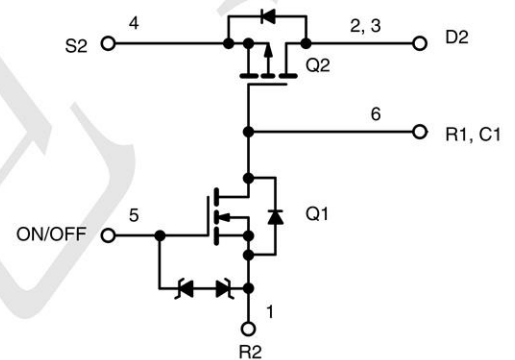

Marking:



Absolute Maximum Ratings ($T_A=25^\circ C$ unless otherwise noted)

Symbol	Parameter	Rating	Unit	
V_{IN}	Input Voltage	20	V	
$V_{ON/OFF}$	ON/OFF Voltage	12		
I_L	Load Current	Continuous ^{a, b}	± 3	A
		Pulsed ^{b, c}	± 10	
I_S	Diode Continuous Forward Current ^a	-1	$^\circ C$	
T_J	Maximum Junction Temperature ^a	150		
T_{STG}	Storage Temperature Range	-55 to 150		
P_D	Maximum Power Dissipation ^a	$T_A=25^\circ C$	0.83	W
V_{ESD}	ESD, MIL-STD-883D HBM (100pF/1.5kohm) (Von/off pin)			KV
R_{qJA}	Thermal Resistance-Junction to Ambient	150		$^\circ C/W$

Note a : Surface Mounted on FR4 Board.

Note b : $V_{IN}=8V, V_{ON/OFF}=8V, T_A=25^\circ C$.

Note c : Pulse test: pulse width $\leq 300ms$, duty cycle $\leq 2\%$.

Electrical Characteristics ($T_A = 25^\circ\text{C}$ unless otherwise noted)

Symbol	Parameter	Test Conditions	Min.	Typ.	Max.	Unit
OFF Characteristics						
I_{FL}	Reverse Leakage Current	$V_{IN}=8\text{V}, V_{ON/OFF}=0\text{V}$	-	-	1	mA
V_{SD}	Diode Forward Voltage	$I_S=-1\text{A}$	-	-0.7	-1.3	V
ON Characteristics						
V_{IN}	Input Voltage Range		3.0	-	20	V
$R_{DS(ON)}$	On-Resistance (Q2)	$V_{IN}=-12\text{V}, I_{DS}=-3\text{A}$	-	55	65	mW
		$V_{IN}=-5.0\text{V}, I_{DS}=-2\text{A}$	-	75	95	
$I_{D(ON)}$	On-State (Q2) Drain-Current	$V_{IN-OUT}\leq 0.2\text{V}, V_{IN}=12\text{V}, V_{ON/OFF}=3.3\text{V}$	2.6	-	-	A
		$V_{IN-OUT}\leq 0.2\text{V}, V_{IN}=5\text{V}, V_{ON/OFF}=3.3\text{V}$	1.7	-	-	

NOTES :

Note a : Surface Mounted on FR4 Board.

Note b : $V_{IN}=8\text{V}, V_{ON/OFF}=8\text{V}, T_A=25^\circ\text{C}$.

Note c : Pulse test: pulse width $\leq 300\text{ms}$, duty cycle $\leq 2\%$.

Typical Application Circuit

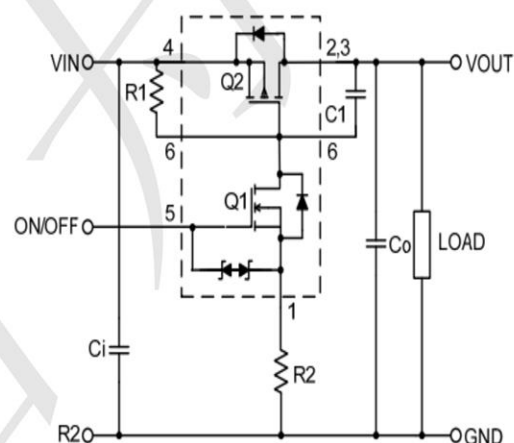

COMPONENTS		
R1	Pull-Up Resistor	Typical $10\text{k}\Omega$ to $1\text{M}\Omega^*$
R2	Optional Slew-Rate Control	Typical 0 to $100\text{k}\Omega$
C1	Optional Slew-Rate Control	Typical 1000pF

Typical Operating Characteristics

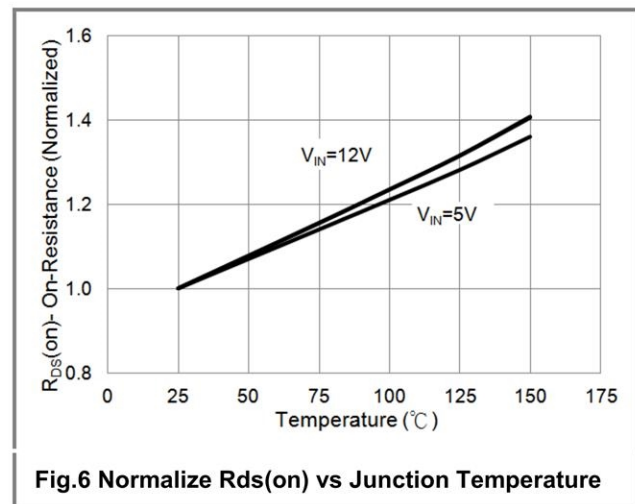
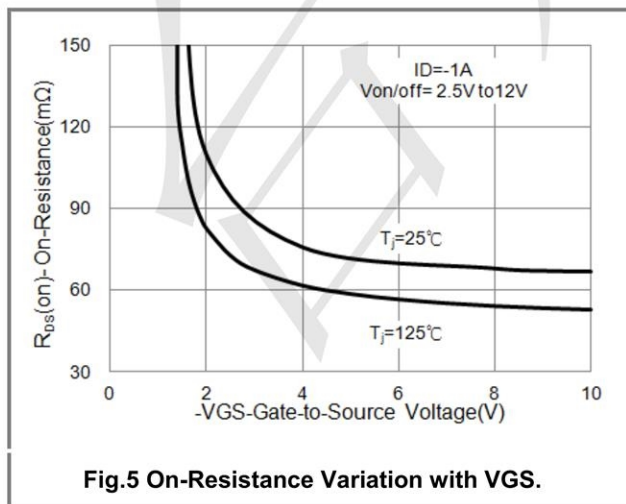
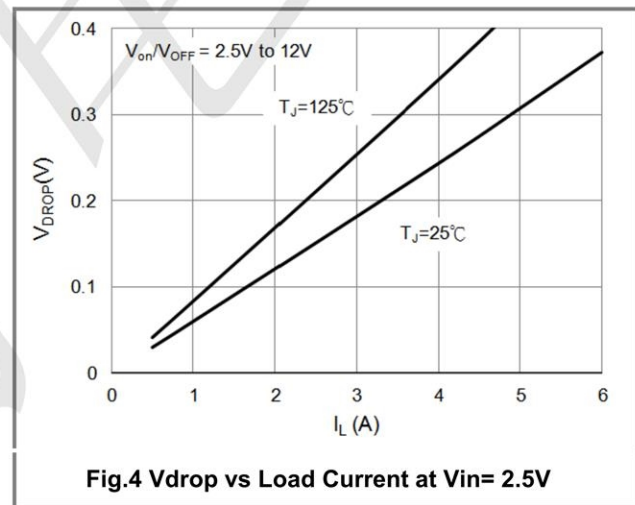
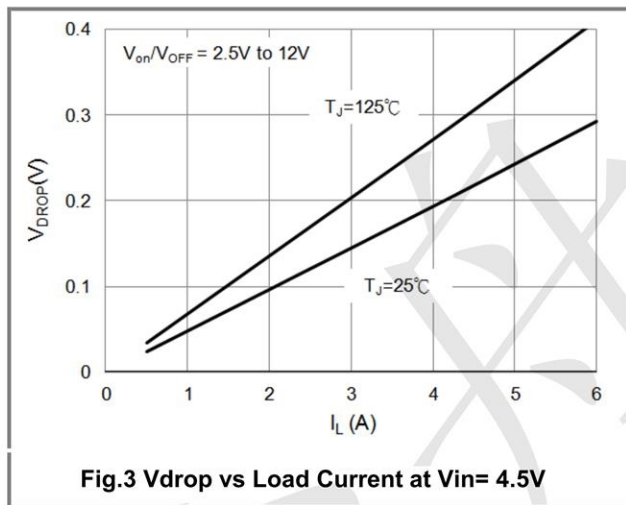
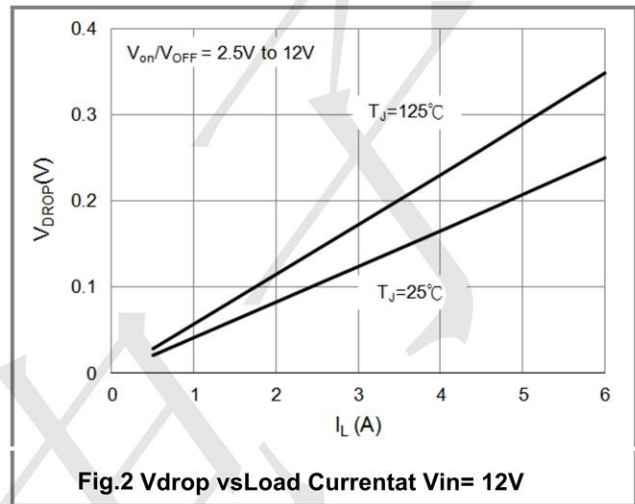
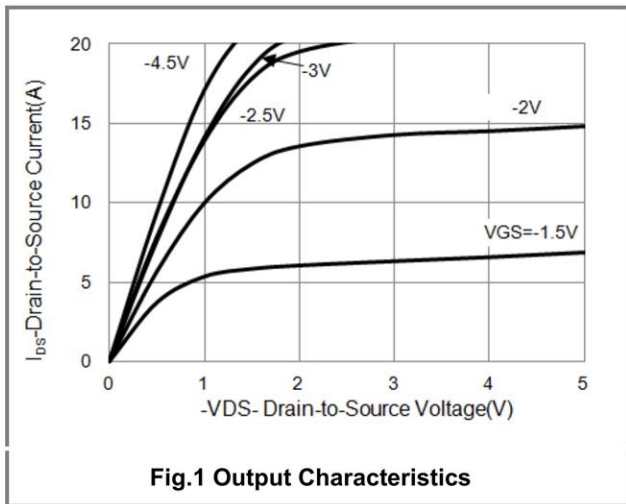

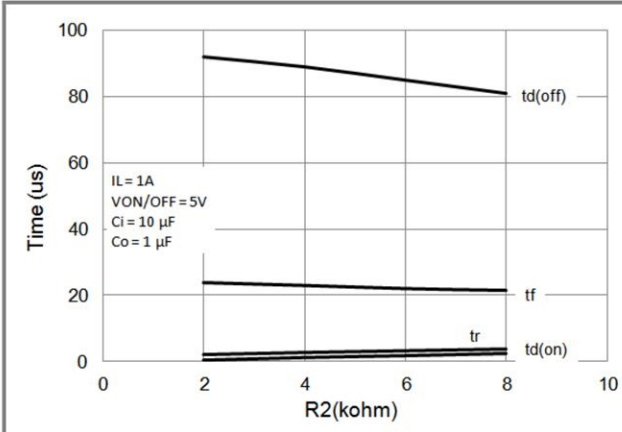

Fig.7 Switching Variation R2 at Vin=12V, R1=20kΩ

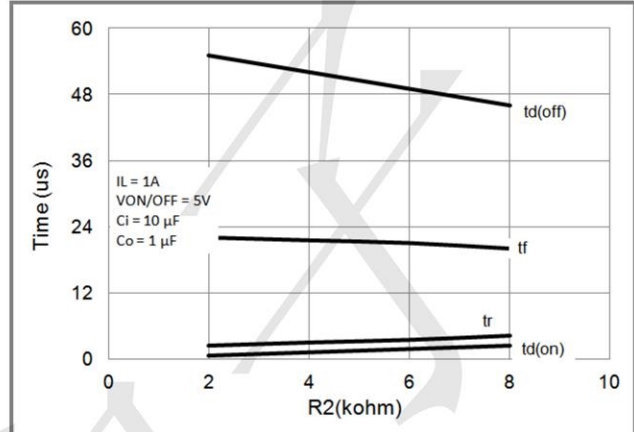

Fig.8 Switching Variation R2 at Vin=5V, R1=20kΩ

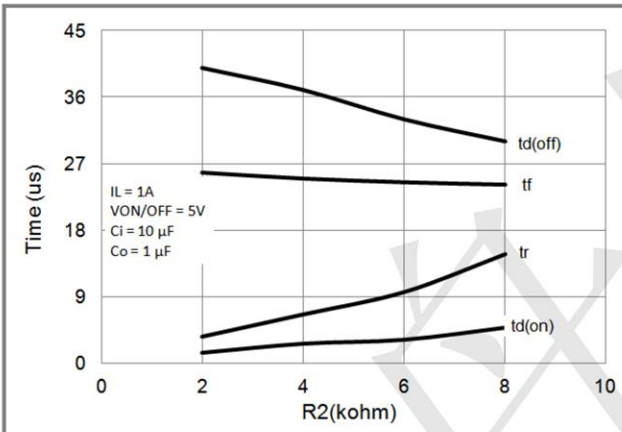

Fig.9 Switching Variation R2 at Vin=3.3V, R1=20kΩ

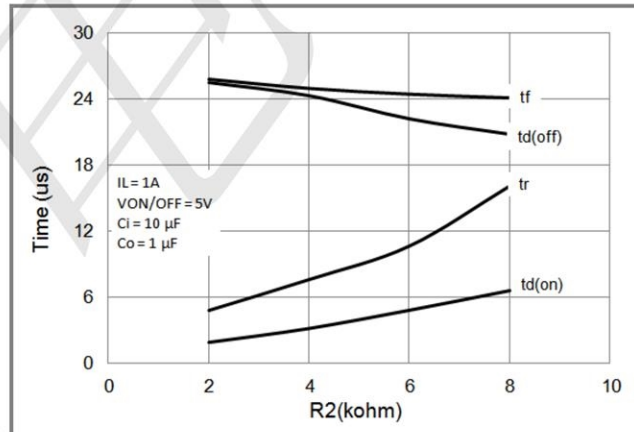

Fig.10 Switching Variation R2 at Vin=2.5V, R1=20kΩ

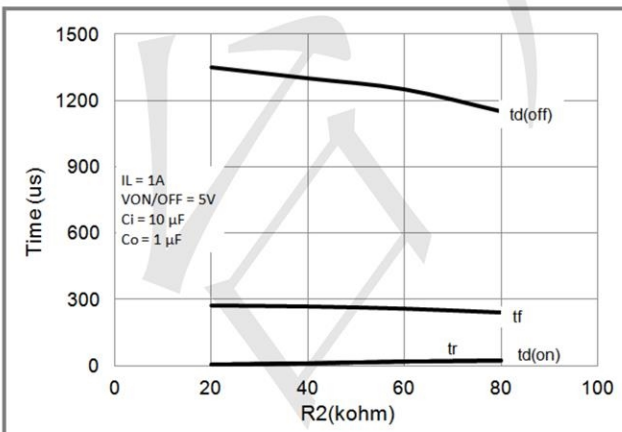

Fig.11 Switching Variation R2 at Vin=12V, R1=300k

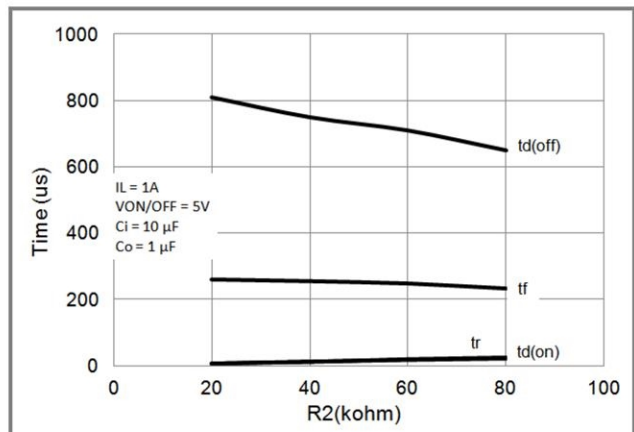
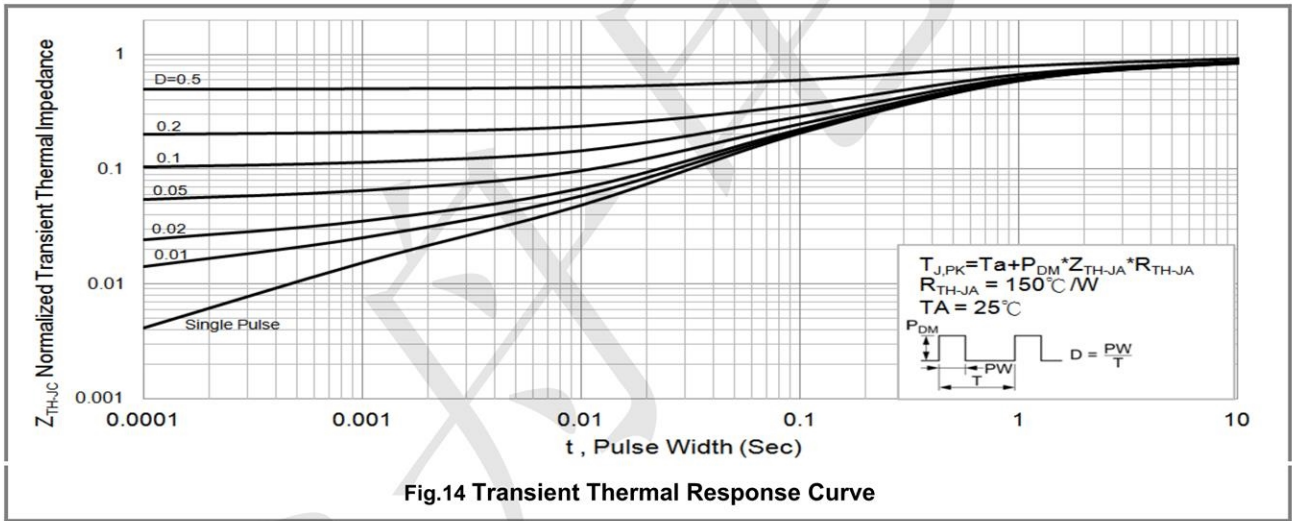
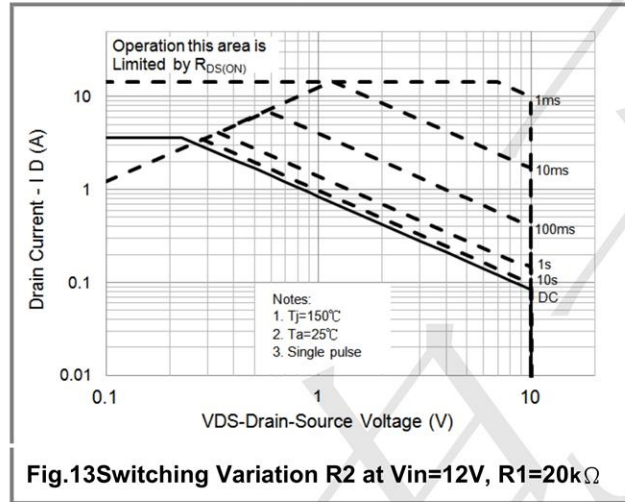

Fig.12 Switching Variation R2 at Vin=5V, R1=300k





TECH PUBLIC

—台丹电子—

TPM3330S6

Integrated Load Switch

www.sot23.com.tw

SOT23-6 Package Information

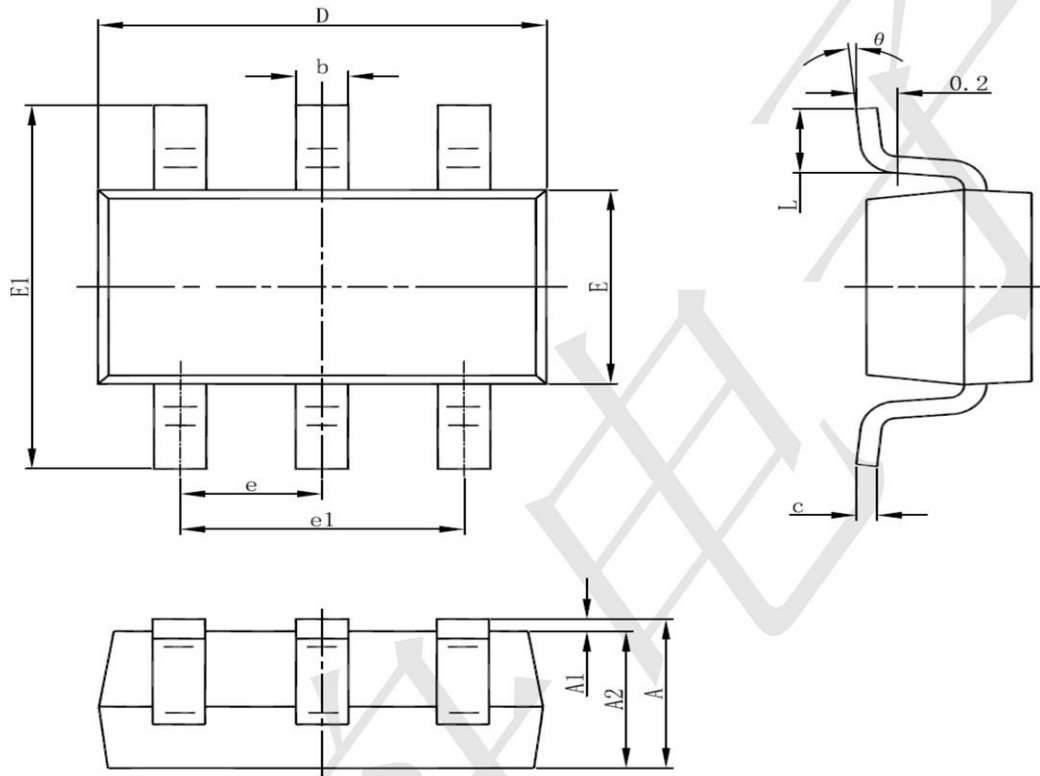

Symbol	Dimensions In Millimeters		Dimensions In Inches	
	Min	Max	Min	Max
A	1.050	1.250	0.041	0.049
A1	0.000	0.100	0.000	0.004
A2	1.050	1.150	0.041	0.045
b	0.300	0.500	0.012	0.020
c	0.100	0.200	0.004	0.008
D	2.820	3.020	0.111	0.119
E	1.500	1.700	0.059	0.067
E1	2.650	2.950	0.104	0.116
e	0.950(BSC)		0.037(BSC)	
e1	1.800	2.000	0.071	0.079
L	0.300	0.600	0.012	0.024
θ	0°	8°	0°	8°