

## Features

- Ultra low leakage: nA level
- Ultra low operating voltage: 5.5V
- Ultra low clamping voltage
- Complies with following standards:
  - IEC 61000-4-2 (ESD) immunity test  
Air discharge:  $\pm 30\text{kV}$   
Contact discharge:  $\pm 30\text{kV}$
  - IEC61000-4-4 (EFT) 80A (5/50ns)
  - IEC61000-4-5 (Lightning) 25A (8/20 $\mu\text{s}$ )
- RoHS Compliant

## Mechanical Characteristics

- Package: SOT23-6
- Lead Finish: NiPdAu
- Case Material: "Green" Molding Compound.
- UL Flammability Classification Rating 94V-0
- Moisture Sensitivity: Level 1 per J-STD-020
- Terminal Connections: See Diagram Below

## Applications

- Ethernet Switches
- Access Points
- Gateways
- Printers
- DVR and NVR

## Dimensions and Pin Configuration

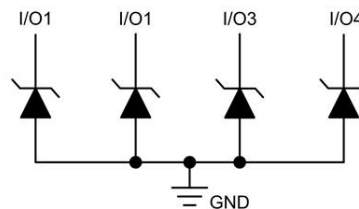
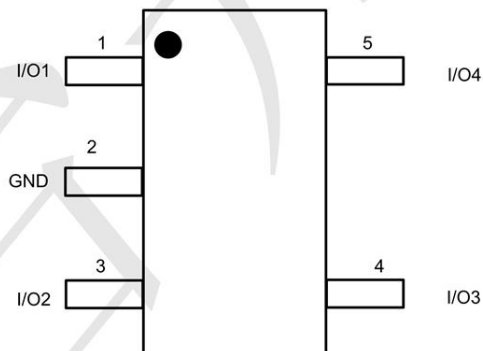

**Absolute Maximum Ratings** (Tamb=25°C unless otherwise specified)

Parameter	Symbol	Value	Unit
Peak Pulse Power (8/20μs)	Ppk	450	W
Peak Pulse Current (8/20μs)	Ipp	25	A
ESD per IEC 61000-4-2 (Air)	VESD	±30	kV
ESD per IEC 61000-4-2 (Contact)		±30	
Operating Temperature Range	TJ	-55 to +125	°C
Storage Temperature Range	Tstg	-55 to +150	°C

**Electrical Characteristics** (TA=25°C unless otherwise specified)

Parameter	Symbol	Min	Typ	Max	Unit	Test Condition
Reverse Working Voltage	VRWM			3.6	V	
Breakdown Voltage	VBR	4.5		7.5	V	IT = 1mA
Reverse Leakage Current	IR			1	uA	VRWM = 3.6V
Forward Voltage	Vf		0.8	1.2	V	Io = 1mA IO to GND
Clamping Voltage	Vc		5	6	V	Ipp=5A(8x 20us pulse)
Clamping Voltage	Vc		12		v	Ipp=25A(8x 20us pulse)
Junction Capacitance	CJ		2.7	3.5	pF	VR = 0V, f = 1MHz IO to GND
Junction Capacitance	CJ		1.3	1.5	pF	VR = 0V, f = 1MHz IO to IO

Typical characteristics ( $T_A=25\text{ C}$ , unless otherwise noted)

Fig1. 8/20 $\mu$ s Pulse Waveform

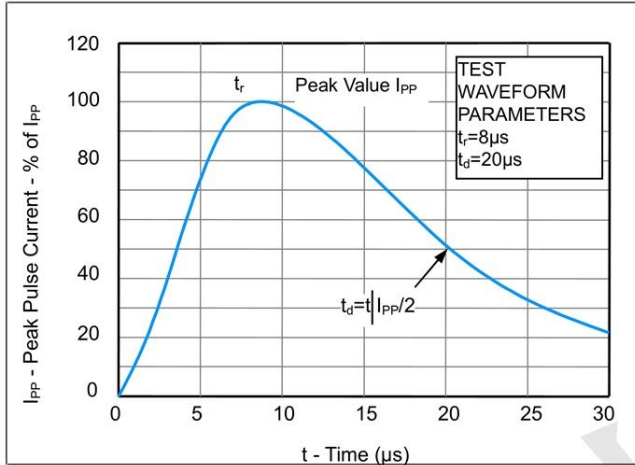

Fig2. ESD Pulse Waveform (according to IEC 61000-4-2)

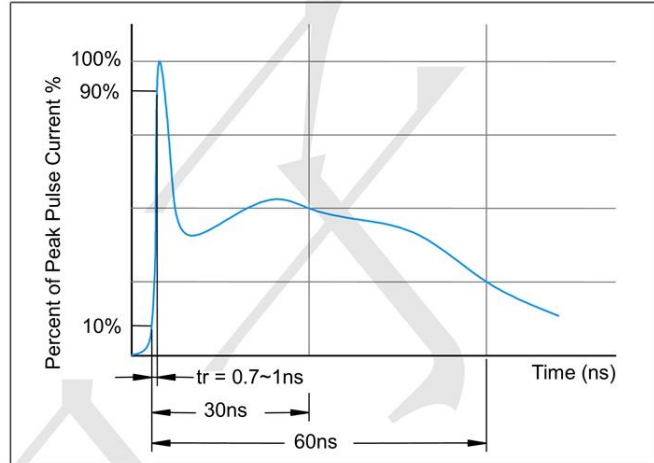
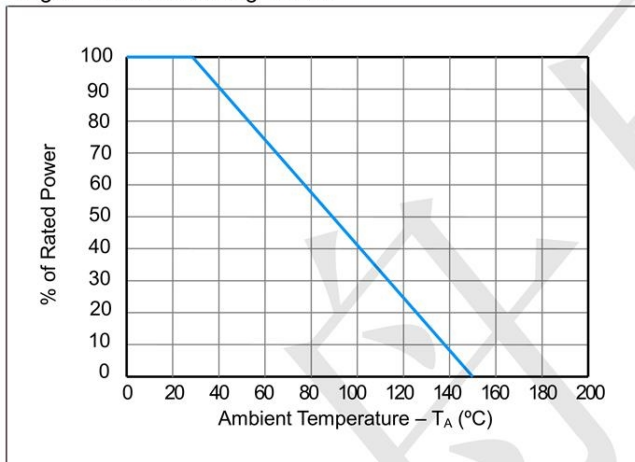
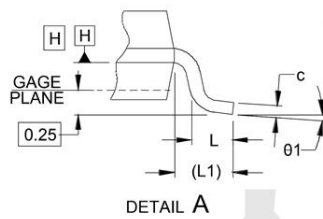
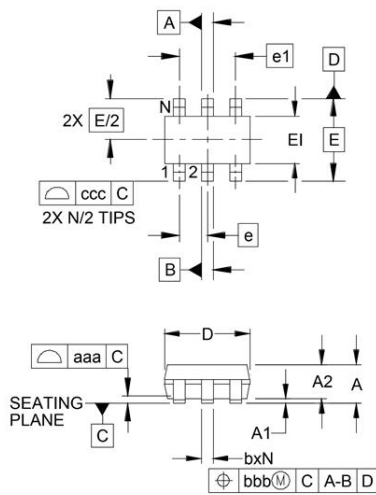

Fig3. Power Derating Curve



**Outline Drawing - SOT23-6**



DIM	INCHES			MILLIMETERS		
	MIN	NOM	MAX	MIN	NOM	MAX
A	.035	-	.057	0.90	-	1.45
A1	.000	-	.006	0.00	-	0.15
A2	.035	.045	.051	.90	1.15	1.30
b	.010	-	.020	0.25	-	0.50
c	.003	-	.009	0.08	-	0.22
D	.110	.114	.118	2.80	2.90	3.00
E1	.060	.063	.069	1.50	1.60	1.75
E	.110 BSC			2.80 BSC		
e	.037 BSC			0.95 BSC		
e1	.075 BSC			1.90 BSC		
L	.012	.018	.024	0.30	0.45	0.60
L1	(0.024)			(0.60)		
N	6			6		
01	0°	-	10°	0°	-	10°
aaa	.004			0.10		
bbb	.008			0.20		
ccc	.008			0.20		

**Land Pattern - SOT23-6**

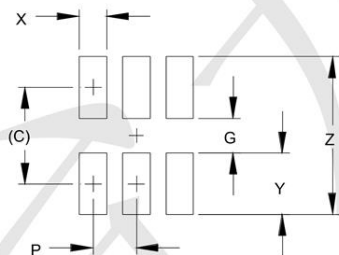

DIM	DIMENSIONS	
	INCHES	MILLIMETERS
C	(.098)	(2.50)
G	.055	1.40
P	.037	0.95
X	.024	0.60
Y	.043	1.10
Z	.141	3.60