

DESCRIPTION

This new series of digital transistors is designed to replace a single device and its external resistor bias network. The BRT (Bias Resistor Transistor) contains a single transistor with a monolithic bias network consisting of two resistors; a series base resistor and a base-emitter resistor. The BRT eliminates these individual components by integrating them into a single device. The use of a BRT can reduce both system cost and board space. The device is housed in the SOT-723 package which is designed for low power surface mount applications.

The DTC144EM ~ DTC144TM are available in SOT-723 package

FEATURES

- Simplifies Circuit Design
- Reduces Board Space
- Reduces Component Count
- The SOT-723 Package can be Soldered using Wave or Reflow.
- Available in 4 mm, 8000 Unit Tape & Reel
- Available in SOT-723 package

ORDERING INFORMATION

Package Type	Part Number
SOT-723	DTC114EM
	DTC124EM
	DTC144EM
	DTC114YM
	DTC114TM
	DTC143TM
	DTC123EM
	DTC143EM
	DTC143ZM
	DTC124XM
	DTC123JM
	DTC115EM
	DTC144WM
	DTC144TM
Note	SPQ: 8,000Pcs/Reel
AiT provides all RoHS Compliant Products	

PIN DESCRIPTION

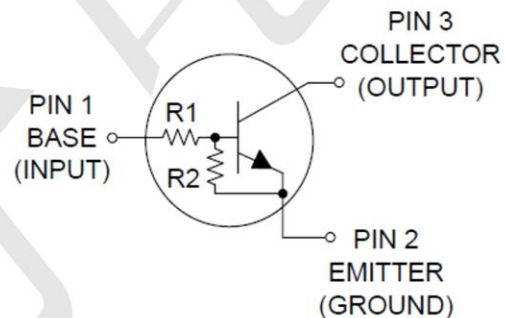

ABSOLUTE MAXIMUM RATINGS

$T_A = 25^\circ\text{C}$, unless otherwise noted

V_{CBO} , Collector-Base Voltage	50Vdc
V_{CEO} , Collector-Emitter Voltage	50Vdc
I_C , Collector Current	100mA _{dc}

Stresses above may cause permanent damage to the device. These are stress ratings only and functional operation of the device at these or any other conditions beyond those indicated in the Electrical Characteristics are not implied. Exposure to absolute maximum rating conditions for extended periods may affect device reliability.

THERMAL CHARACTERISTICS

Parameter	Symbol	Value	Unit
Total Device Dissipation $T_A = 25^\circ\text{C}$ Derate above 25°C	P_D	260 ^{NOTE1}	mW
		600 ^{NOTE2}	
		2.0 ^{NOTE1}	mW/ $^\circ\text{C}$
		4.8 ^{NOTE2}	
Thermal Resistance – Junction-to-Ambient	$R_{\theta JA}$	480 ^{NOTE1} 205 ^{NOTE2}	$^\circ\text{C}/\text{W}$
Junction Temperature	T_J	150	$^\circ\text{C}$
Storage Temperature Range	T_{STG}	-55 to +150	$^\circ\text{C}$

NOTE1: FR-4 @ Minimum Pad

NOTE2: FR-4 @ 1.0 x 1.0 inch Pad

ELECTRICAL CHARACTERISTICS

T_A = 25°C, unless otherwise noted

Parameter	Symbol	Conditions	Min.	Typ.	Max.	Unit			
OFF CHARACTERISTICS									
Collector-Base Cutoff Current	I _{CBO}	V _{CB} = 50V, I _E = 0	-	-	100	nAdc			
Collector-Emitter Cutoff Current	I _{CEO}	V _{CE} = 50V, I _B = 0	-	-	500	nAdc			
Emitter-Base Cutoff Current	I _{EBO}	V _{EB} = 6.0V, I _C = 0	-	-	DTC114EM	0.5			
					DTC124EM	0.2			
					DTC144EM	0.1			
					DTC114YM	0.2			
					DTC114TM	0.9			
					DTC143TM	1.9			
					DTC123EM	2.3			
					DTC143EM	1.5			
					DTC143ZM	0.18			
					DTC124XM	0.13			
					DTC123JM	0.2			
					DTC115EM	0.05			
					DTC144WM	0.13			
DTC144TM	0.2								
Collector-Base Breakdown Voltage	V _{(BR)CBO}	I _C = 10μA, I _E = 0	50	-	-	Vdc			
Collector-Emitter Breakdown Voltage ^{NOTE3}	V _{(BR)CEO}	I _C = 2.0mA, I _B = 0	50	-	-	Vdc			
ON CHARACTERISTICS^{NOTE3}									
DC Current Gain	h _{FE}	V _{CE} =10V, I _C =5.0mA			DTC114EM	35	60		
					DTC124EM	60	100		
					DTC144EM	80	140		
					DTC114YM	80	140		
					DTC114TM	160	350		
					DTC143TM	160	350		
					DTC123EM	8.0	15		
					DTC143EM	15	30		
					DTC143ZM	80	200		
					DTC124XM	80	150		
					DTC123JM	80	140		
					DTC115EM	80	150		
					DTC144WM	80	140		
DTC144TM	160	350							

Parameter	Symbol	Conditions	Min.	Typ.	Max.	Unit	
Collector-Emitter Saturation Voltage	$V_{CE(sat)}$	$I_C = 10\text{mA}, I_B = 0.3\text{mA}$	-	-	0.25	Vdc	
		$I_C = 10\text{mA}, I_B = 5\text{mA}$					DTC123EM
		$I_C = 10\text{mA}, I_B = 1\text{mA}$					DTC143TM DTC114TM DTC143EM DTC143ZM DTC124XM DTC144TM
Output Voltage (on)	V_{OL}	$V_{CC} = 5.0\text{V}, V_B = 2.5\text{V}, R_L = 1.0\text{k}\Omega$	-	-	0.2	Vdc	
					DTC114EM DTC124EM DTC114YM DTC114TM DTC143TM DTC123EM DTC143EM DTC143ZM DTC124XM DTC123JM		0.2
		$V_{CC} = 5.0\text{V}, V_B = 3.5\text{V}, R_L = 1.0\text{k}\Omega$			DTC144EM DTC144TM		0.2
		$V_{CC} = 5.0\text{V}, V_B = 5.5\text{V}, R_L = 1.0\text{k}\Omega$			DTC115EM		0.2
		$V_{CC} = 5.0\text{V}, V_B = 4.0\text{V}, R_L = 1.0\text{k}\Omega$			DTC144WM		0.2
Output Voltage (off)	V_{OH}	$V_{CC} = 5.0\text{V}, V_B = 0.5\text{V}, R_L = 1.0\text{k}\Omega$	4.9	-	-	Vdc	
		$V_{CC} = 5.0\text{V}, V_B = 0.25\text{V}, R_L = 1.0\text{k}\Omega$					DTC143TM DTC143ZM DTC114TM DTC144TM

Parameter	Symbol	Conditions	Min.	Typ.	Max.	Unit	
Input Resistor	R1	DTC114EM	7.0	10	13	kΩ	
		DTC124EM	15.4	22	28.6		
		DTC144EM	32.9	47	61.1		
		DTC114YM	7.0	10	13		
		DTC114TM	7.0	10	13		
		DTC143TM	3.3	4.7	6.1		
		DTC123EM	1.5	2.2	2.9		
		DTC143EM	3.3	4.7	6.1		
		DTC143ZM	3.3	4.7	6.1		
		DTC124XM	15.4	22	28.6		
		DTC123JM	1.54	2.2	2.86		
		DTC115EM	70	100	130		
		DTC144WM	32.9	47	61.1		
		DTC144TM	32.9	47	61.1		
Resistor Ratio	R ₁ /R ₂	DTC114EM/DTC124EM/ DTC144EM/DTC115EM	0.8	1.0	1.2		
		DTC114YM	0.17	0.21	0.25		
		DTC143TM/DTC114TM/ DTC144TM	-	-	-		
		DTC123EM/DTC143EM	0.8	1.0	1.2		
		DTC143ZM	0.055	0.1	0.185		
		DTC124XM	0.38	0.47	0.56		
		DTC123JM	0.038	0.047	0.056		
		DTC144WM	1.7	2.1	2.6		
		Input Voltage	V _{I(off)}	V _{CC} = 5.0V, I _O = 100μA	DTC123JM	-	-
Input Voltage	V _{I(on)}	V _O = 0.3V, I _O = 5mA	DTC123JM	1.1	-	-	V

NOTE3: Pulse Test: Pulse Width < 300 μs, Duty Cycle < 2.0%

RESISTOR VALUES

Device	R1 (k)	R2 (k)
DTC114EM	10	10
DTC124EM	22	22
DTC144EM	47	47
DTC114YM	10	47
DTC114TM	10	∞
DTC143TM	4.7	∞
DTC123EM	2.2	2.2
DTC143EM	4.7	4.7
DTC143ZM	4.7	47
DTC124XM	22	47
DTC123JM	2.2	47
DTC115EM	100	100
DTC144WM	47	22
DTC144TM	47	∞

TYPICAL CHARACTERISTICS

Figure 1. Derating Curve

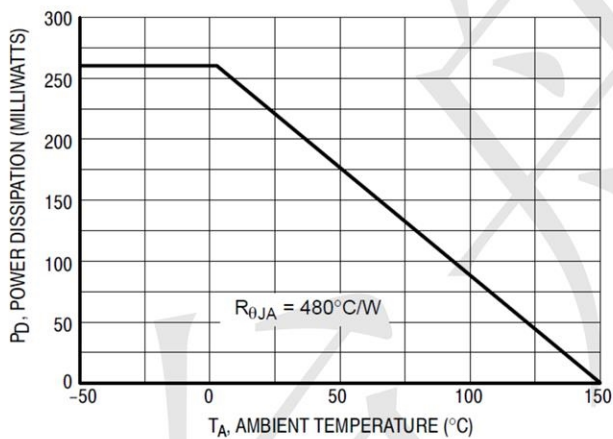

DTC114EM

Figure 2. $V_{CE(sat)}$ vs. I_C

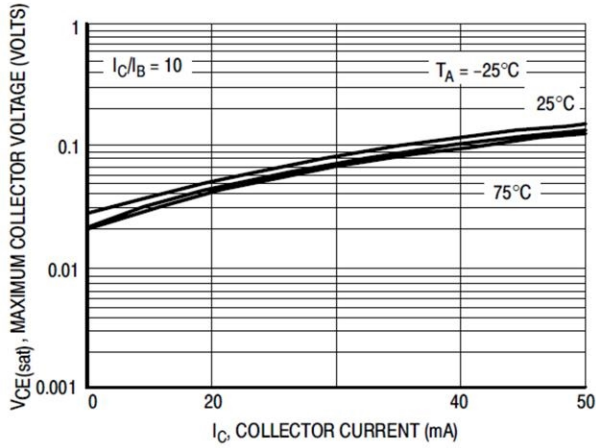

Figure 4. Output Capacitance

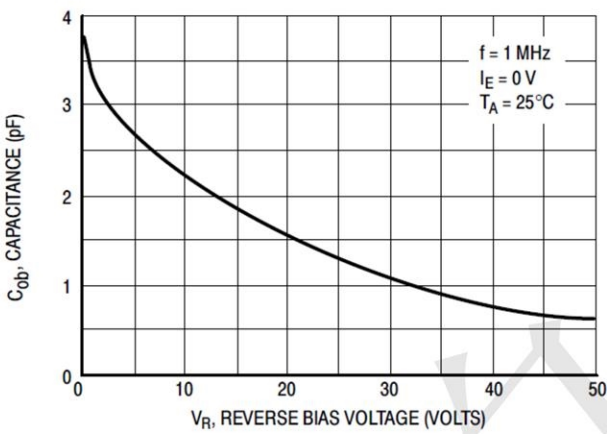

Figure 6. Input Voltage vs. Output Current

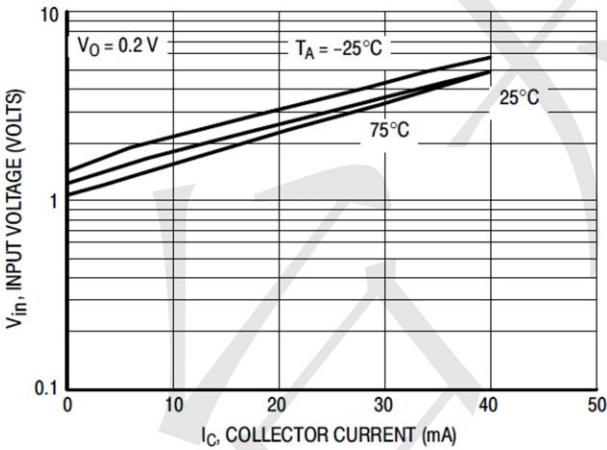

Figure 3. DC Current Gain

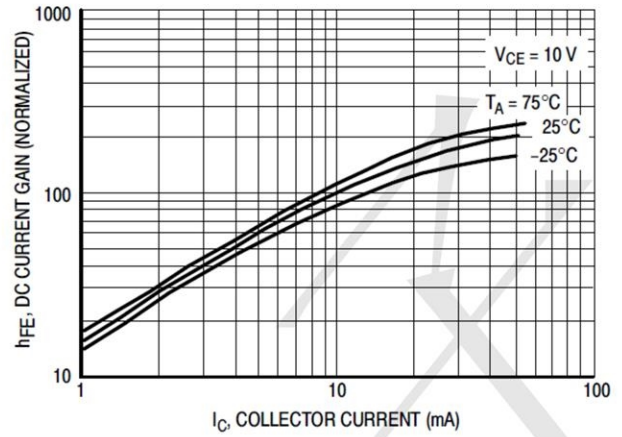
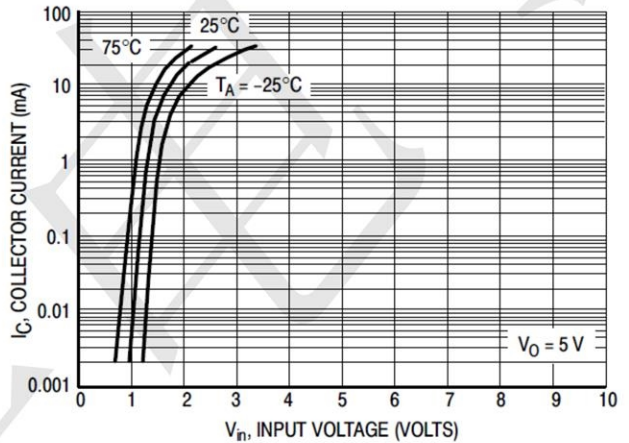

Figure 5. Output Current vs. Input Voltage



DTC124EM

Figure 7. $V_{CE(sat)}$ vs. I_C

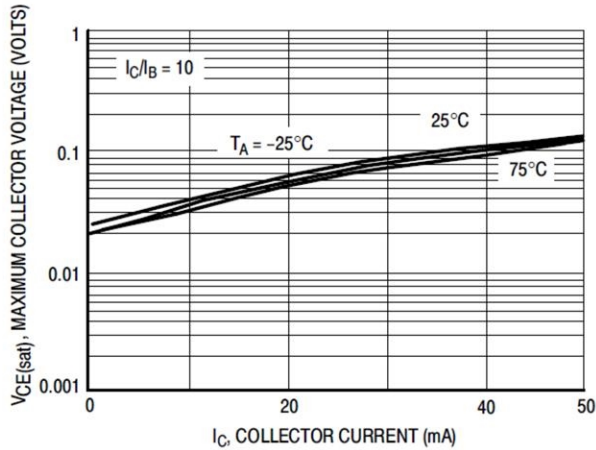

Figure 8. DC Current Gain

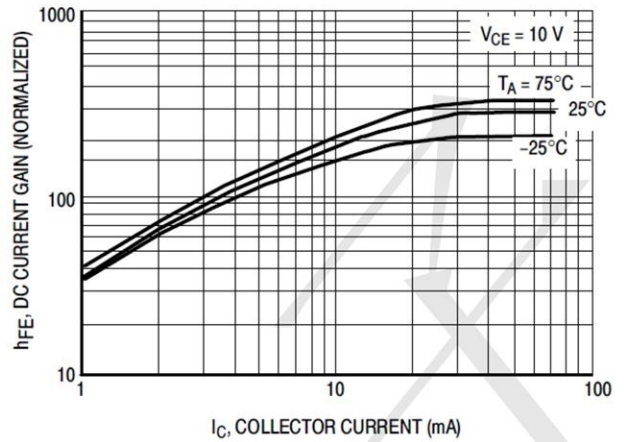

Figure 9. Output Capacitance

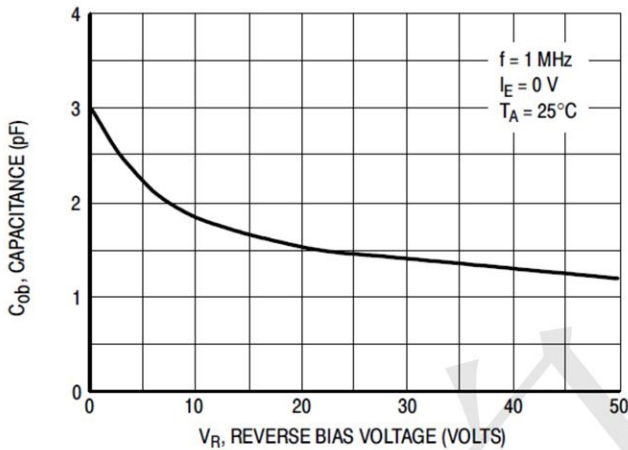

Figure 10. Output Current vs. Input Voltage

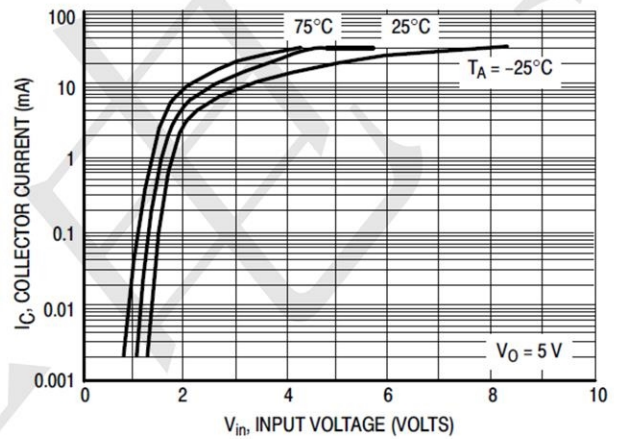
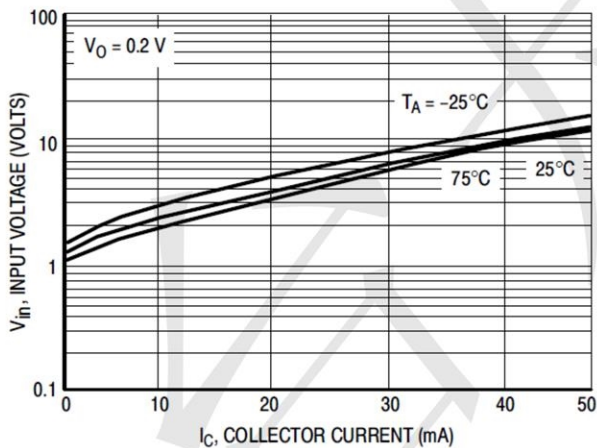

Figure 11. Input Voltage vs. Output Current



DTC144EM

Figure 12. $V_{CE(sat)}$ vs. I_C

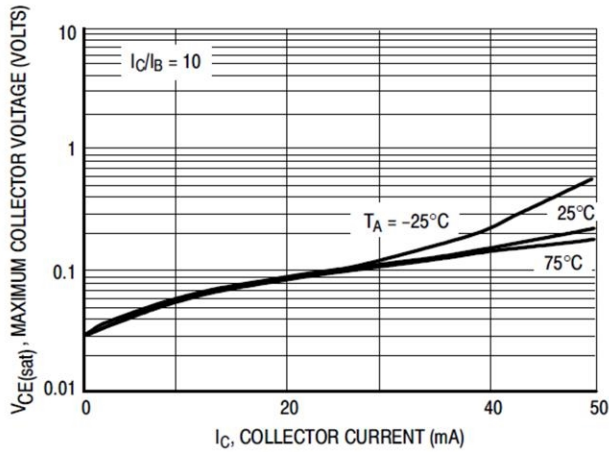

Figure 14. Output Capacitance

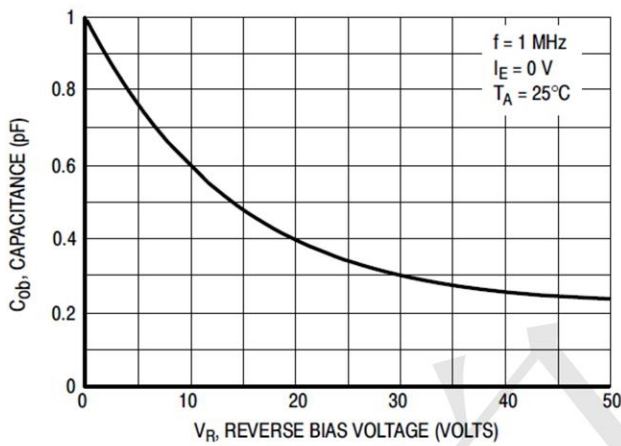

Figure 16. Input Voltage vs. Output Current

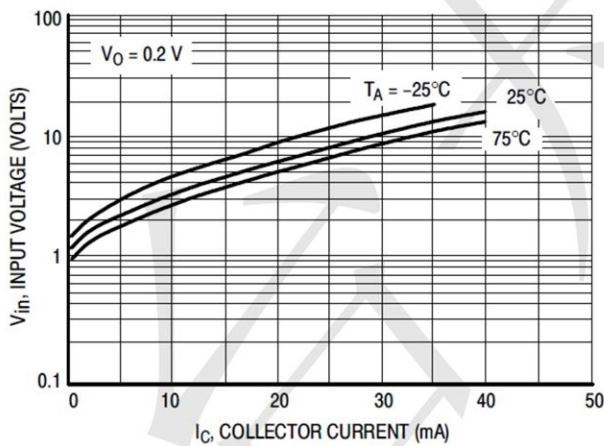

Figure 13. DC Current Gain

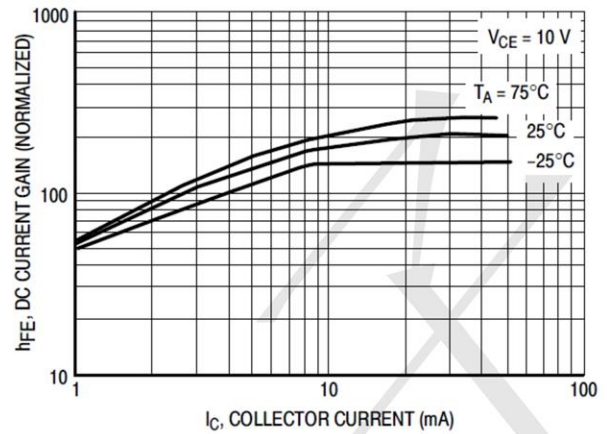
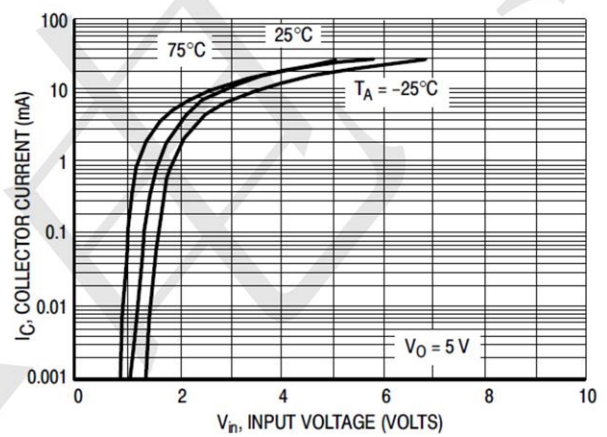

Figure 15. Output Current vs. Input Voltage



DTC114YM

Figure 17. $V_{CE(sat)}$ vs. I_C

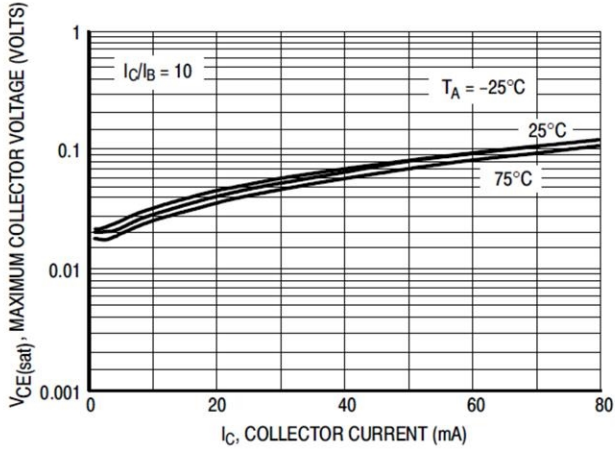

Figure 19. Output Capacitance

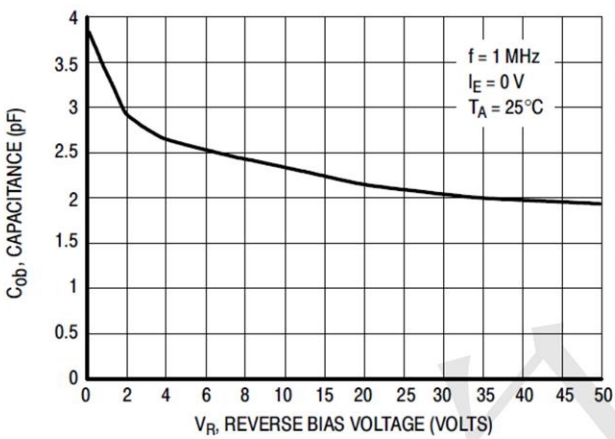

Figure 21. Input Voltage vs. Output Current

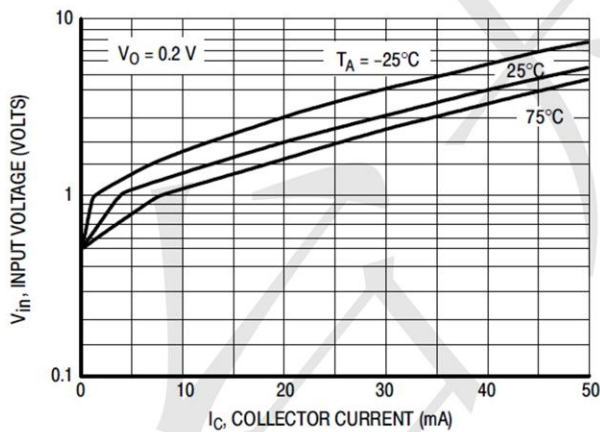

Figure 18. DC Current Gain

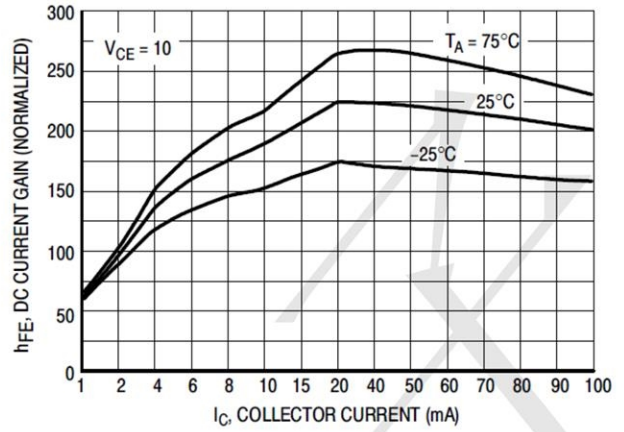
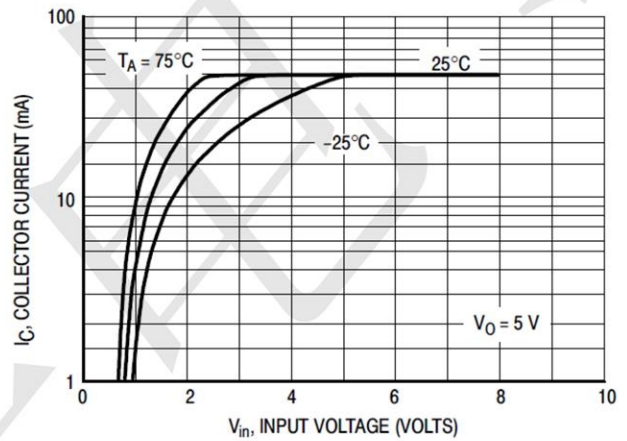

Figure 20. Output Current vs. Input Voltage



DTC143ZM

Figure 22. $V_{CE(sat)}$ versus I_C

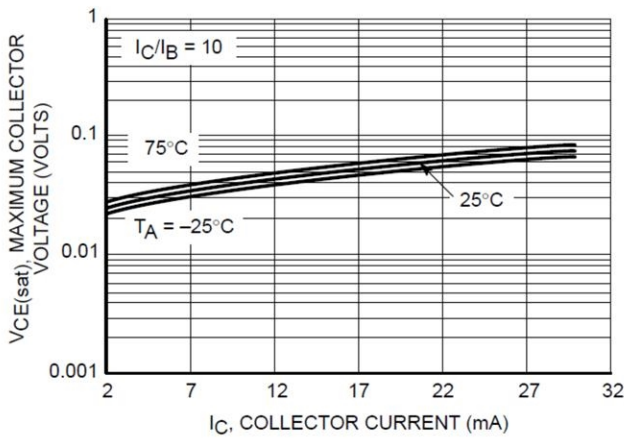

Figure 24. Output Capacitance

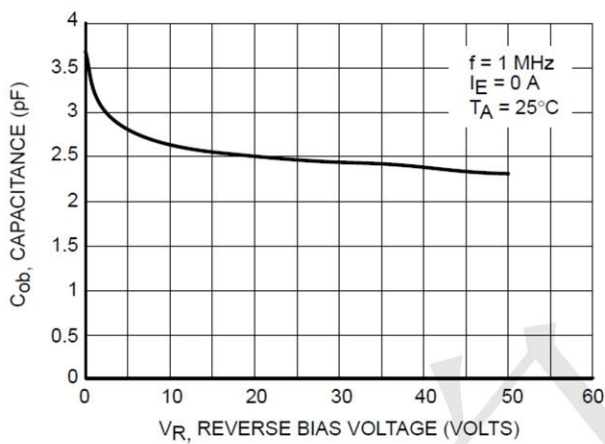

Figure 23. DC Current Gain

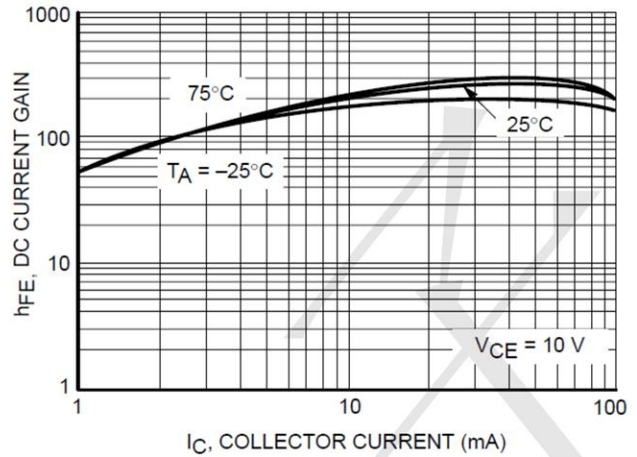

Figure 25. Output Current vs. Input Voltage

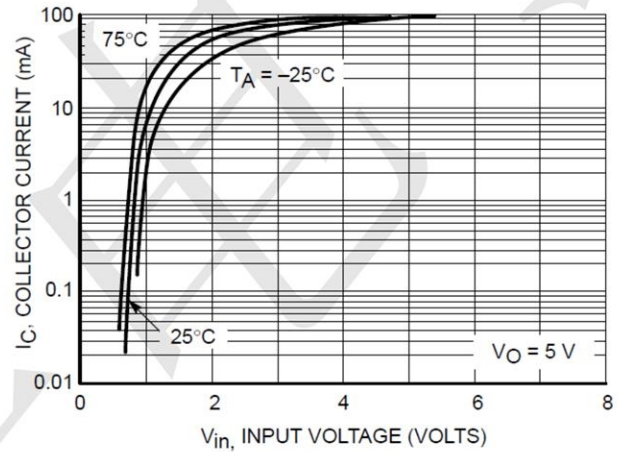
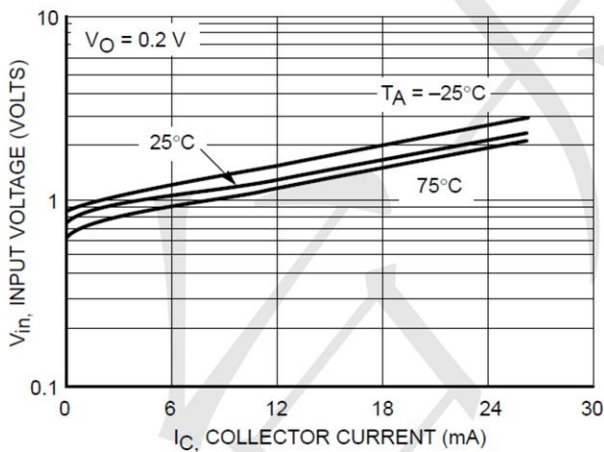

Figure 26. Input Voltage vs. Output Current



TYPICAL APPLICATIONS FOR NPN BRTs

Figure 27. Level Shifter: Connects 12 or 24 Volt Circuits to Logic

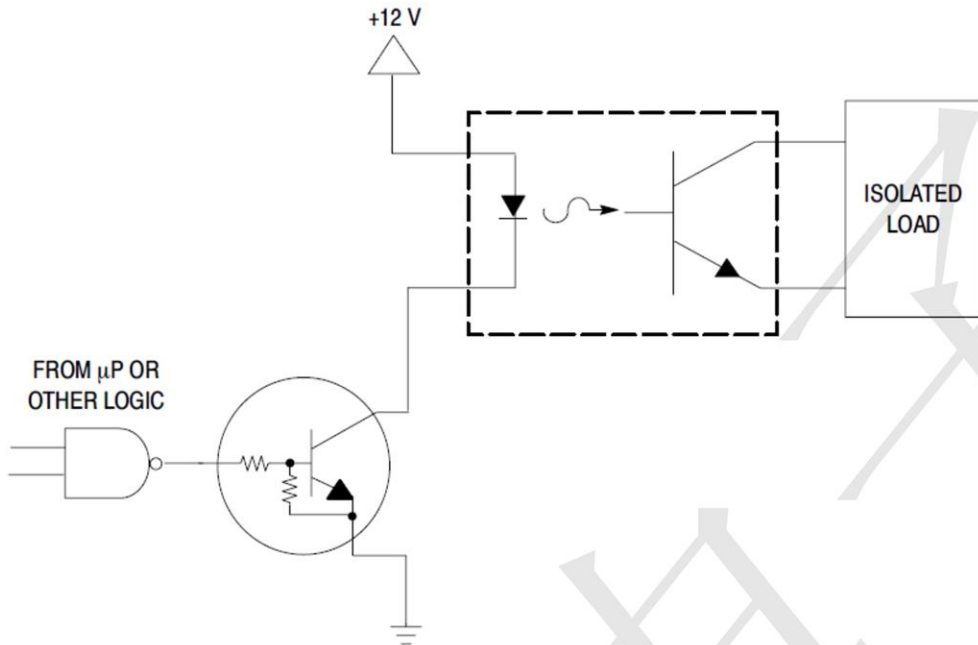

Figure 28. Open Collector Inverter:
 Inverts the Input Signal

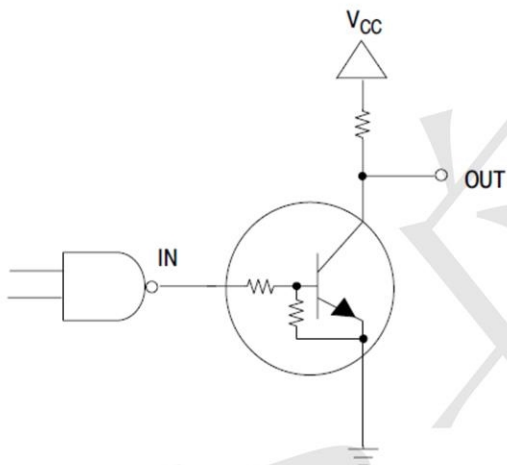
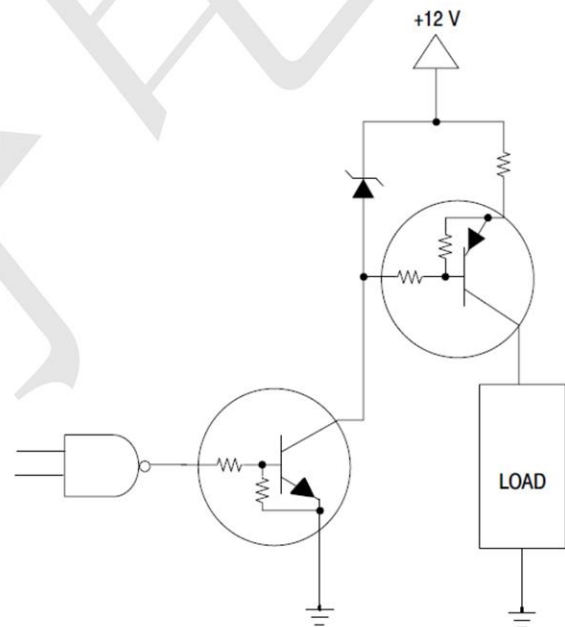
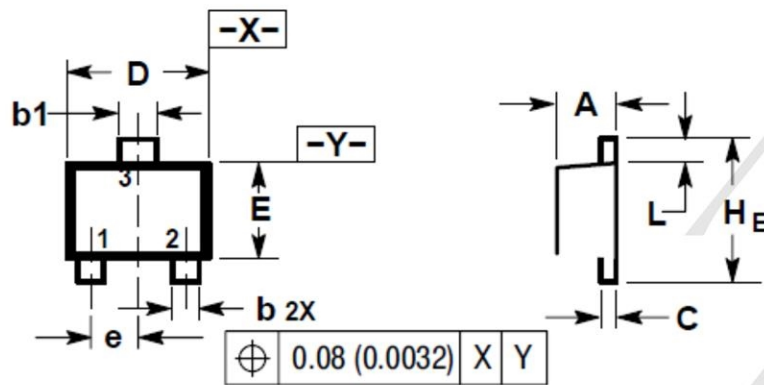

Figure 29. Inexpensive, Unregulated Current Source



PACKAGE INFORMATION

Dimension in SOT-723 (Unit: mm)



SOLDERING FOOTPRINT

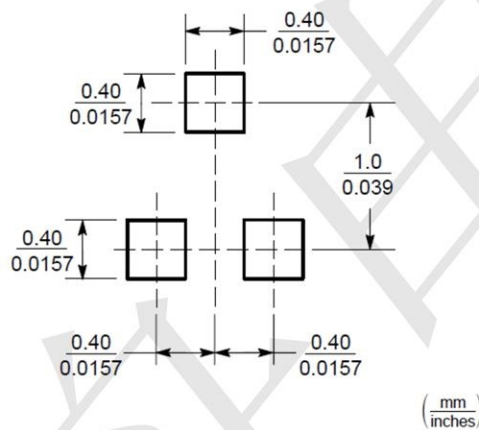

DIM	MILLIMETERS		INCHES	
	MIN	MAX	MIN	MAX
A	0.45	0.55	0.018	0.022
b	0.15	0.27	0.0059	0.0106
b1	0.25	0.35	0.010	0.014
C	0.07	0.17	0.0028	0.0067
D	1.15	1.25	0.045	0.049
E	0.75	0.85	0.03	0.034
e	0.40 BSC		0.016 BSC	
HE	1.15	1.25	0.045	0.049
L	0.15	0.25	0.0059	0.0098