

SOD-123FL Plastic-Encapsulate Diodes

DSS115 THRU DSS120 Schottky Rectifier Diodes

Features

- $I_{F(AV)}$ 1A
- V_{RRM} 150V-200V
- High surge current capability
- Polarity: Color band denotes cathode

Applications

- Rectifier

Marking

- DSS115:S115
- DSS120:S120

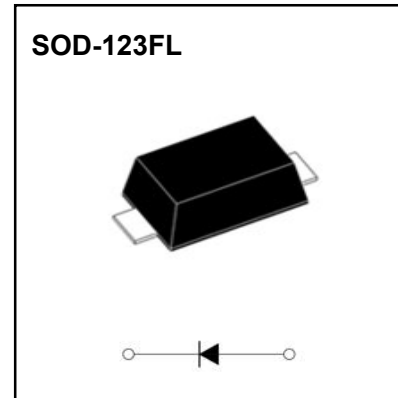

Limiting Values(Absolute Maximum Rating)

Item	Symbol	Unit	Test Conditions	DSS1	
				15	20
Repetitive Peak Reverse Voltage	V_{RRM}	V		150	200
Maximum RMS Voltage	V_{RMS}	V		105	140
Average Forward Current	$I_{F(AV)}$	A	60Hz Half-sine wave, Resistance load, FIG.1	1.0	
Surge(Non-repetitive)Forward Current	I_{FSM}	A	60Hz Half-sine wave, 1 cycle, $T_a=25^\circ\text{C}$	30	
Junction Temperature	T_J	$^\circ\text{C}$		-55 ~ +150	
Storage Temperature	T_{STG}	$^\circ\text{C}$		-55 ~ +150	

Electrical Characteristics (T=25°C Unless otherwise specified)

Item	Symbol	Unit	Test Condition	DSS1	
				15	20
Peak Forward Voltage	V_F	V	$I_F=1.0\text{A}$	0.95	
Peak Reverse Current	I_{RRM1}	mA	$V_{RM}=V_{RRM}$	$T_a=25^\circ\text{C}$	0.1
	I_{RRM2}			$T_a=100^\circ\text{C}$	0.2
Thermal Resistance(Typical)	$R_{\theta J-A}$	$^\circ\text{C}/\text{W}$	Between junction and ambient	88	
	$R_{\theta J-L}$		Between junction and terminal	28	

Notes:

Thermal resistance from junction to ambient and from junction to lead mounted on P.C.B. with 0.2" x 0.2" (5.0 mm x 5.0 mm) copper pad areas

Typical Characteristics

FIG.1: FORWARD CURRENT DERATING CURVE

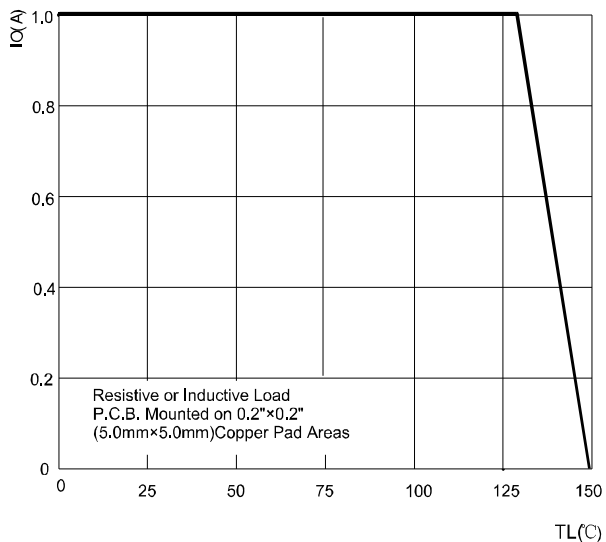

FIG2: SURGE FORWARD CURRENT CAPABILITY

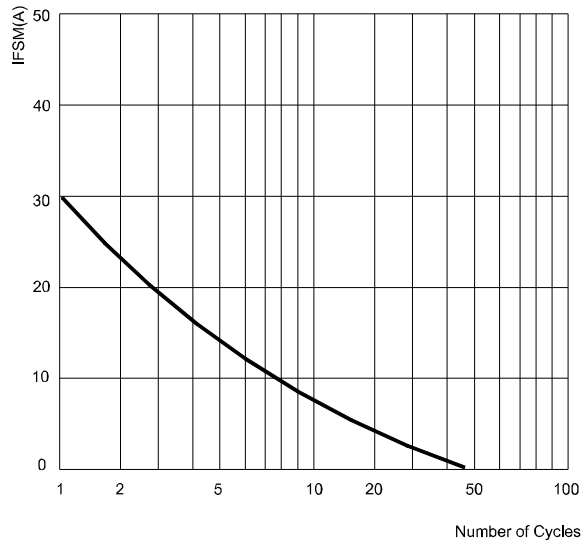

FIG3: TYPICAL FORWARD CHARACTERISTICS

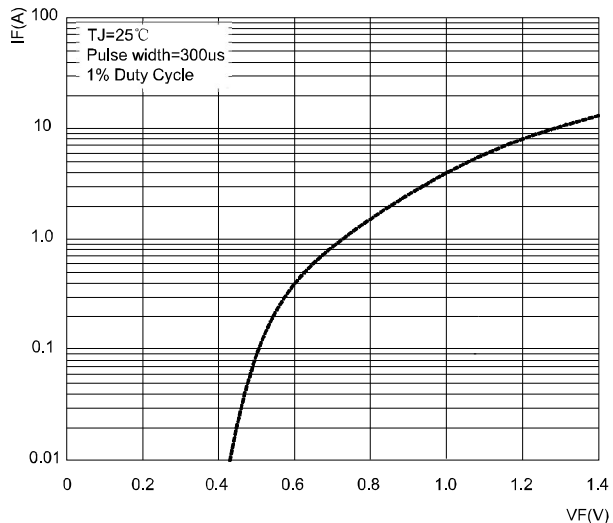
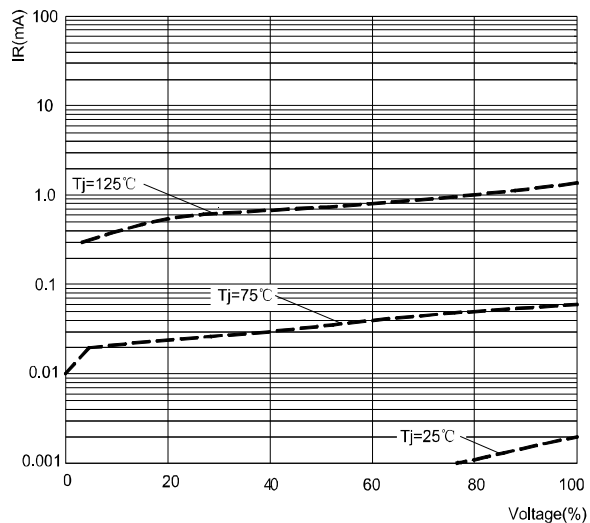
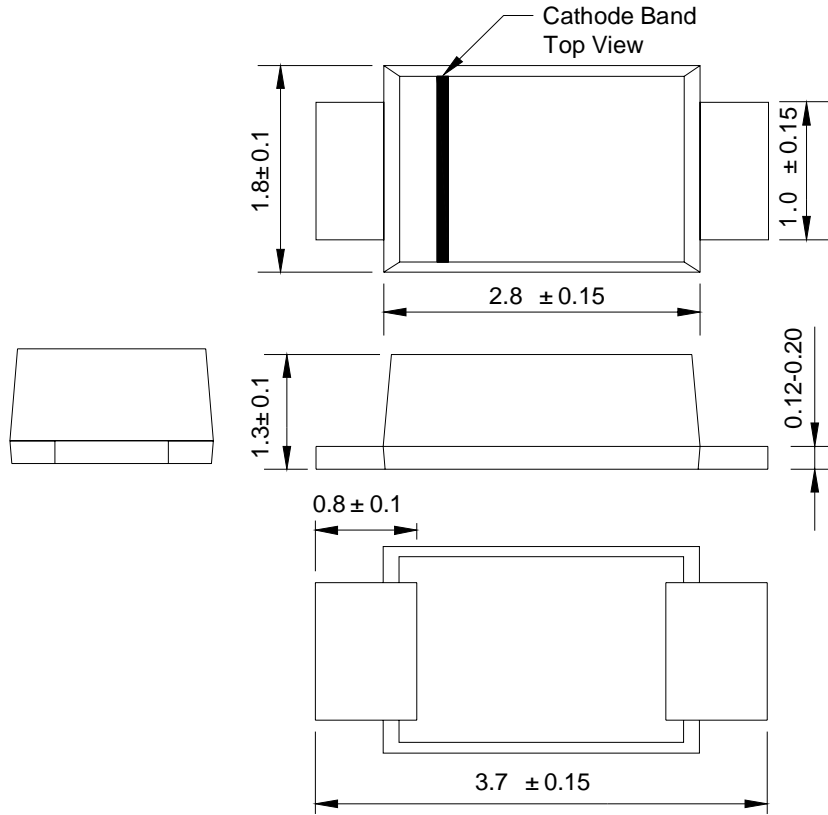

FIG.4 : TYPICAL REVERSE CHARACTERISTICS



SOD-123FL Package Outline Dimensions



Dimensions in millimeters

SOD-123FL Suggested Pad Layout

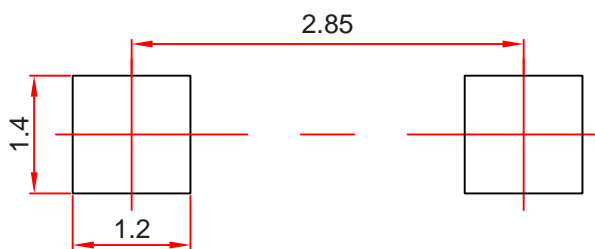

Note:

1. Controlling dimension: in millimeters.
2. General tolerance: ± 0.05 mm.
3. The pad layout is for reference purposes only.

NOTICE

JSCJ reserves the right to make modifications, enhancements, improvements, corrections or other changes without further notice to any product herein. JSCJ does not assume any liability arising out of the application or use of any product described herein.

Reel Taping Specifications For Surface Mount Devices-SOD-123FL



FIG: CONFIGURATION OF SURFACE MOUNTED DEVICES TAPING

ITEM	SYMBOL	SOD-123FLmm(inch)
Carrier width	A	2.05±0.1(0.081±0.004)
Carrier length	B	3.95±0.1(0.156±0.004)
Carrier depth	C	1.45±0.1(0.057±0.004)
Sprocket hole	d	1.55±0.05(0.061±0.002)
Reel outside diameter	D	178±2.0(7.0±0.079)
Reel inner diameter	D1	54±1.0(2.13±0.039)
Feed hole diameter	D2	13±0.5(0.512±0.020)
Sprocket hole position	E	1.75±0.1(0.069±0.004)
Punch hole position	F	3.50±0.1(0.138±0.002)
Punch hole pitch	P	4.0±0.1(0.157±0.004)
Sprocket hole pitch	P0	4.0±0.1(0.157±0.004)
Embossment center	P1	2.0±0.1(0.079±0.004)
Totall tape thickness	T	0.21±0.25(0.008±0.010)
Tape width	W	8.0±0.2(0.315±0.008)
Reel width	W1	10.0±2.0(0.394±0.079)

NOTE: Devices are packed in accordance with EIA standard RS-481-A and specification given above.