



2SD667

NPN SILICON TRANSISTOR

SILICON NPN EPITAXIAL

DESCRIPTION

The UTC **2SD667** is a NPN epitaxial silicon transistor, which can be used as a low frequency power amplifier.

FEATURES

* Low frequency power amplifier

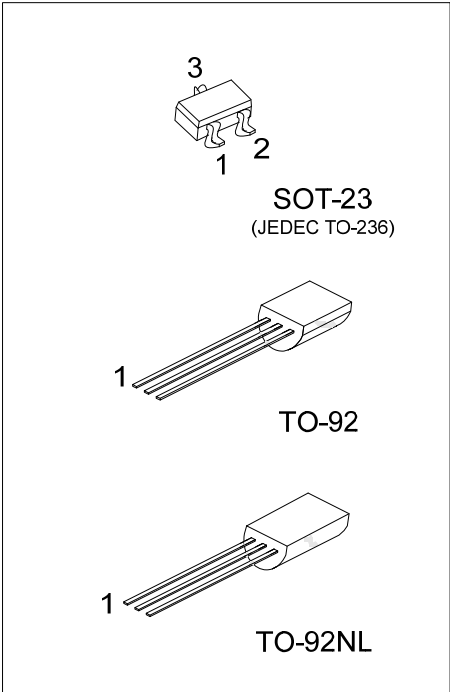

ORDERING INFORMATION

Ordering Number		Package	Pin Assignment			Packing
Lead Free	Halogen Free		1	2	3	
2SD667L-x-AE3-R	2SD667G-x-AE3-R	SOT-23	B	E	C	Tape Reel
2SD667L-x-T92-B	2SD667G-x-T92-B	TO-92	E	C	B	Tape Box
2SD667L-x-T92-K	2SD667G-x-T92-K	TO-92	E	C	B	Bulk
2SD667L-x-T9N-B	2SD667G-x-T9N-B	TO-92NL	E	C	B	Tape Box
2SD667L-x-T9N-K	2SD667G-x-T9N-K	TO-92NL	E	C	B	Bulk

Note: Pin Assignment: B: Base E: Emitter C: Collector

<p>2SD667G-x-AE3-R</p> <p>(1) Packing Type (2) Package Type (3) Rank (4) Green Package</p>	<p>(1) R: Tape Reel, B: Tape Box, K: Bulk (2) AE3: SOT-23, T92: TO-92, T9N: TO-92NL (3) refer to CLASSIFICATION OF h_{FE1} (4) G: Halogen Free and Lead Free, L: Lead Free</p>
--	---

■ MARKING

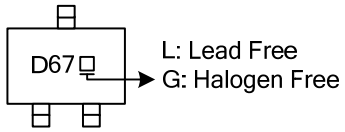
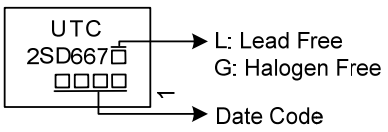
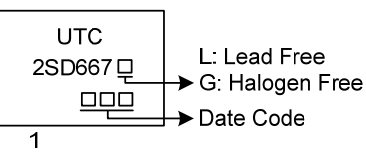
SOT-23	TO-92NL
 <p>L: Lead Free G: Halogen Free</p>	 <p>L: Lead Free G: Halogen Free Date Code</p>
TO-92	-
 <p>L: Lead Free G: Halogen Free Date Code</p> <p>1</p>	-

■ ABSOLUTE MAXIMUM RATINGS ($T_A=25^\circ\text{C}$, unless otherwise specified)

PARAMETER		SYMBOL	RATINGS	UNIT
Collector to Base Voltage		V_{CBO}	120	V
Collector to Emitter Voltage		V_{CEO}	80	V
Emitter to Base Voltage		V_{EBO}	6	V
Collector Current		I_C	1.0	A
Collector Peak Current (Note2)		I_{CP}	2.0	A
Collector Power Dissipation	SOT-23	P_C	0.35	W
	TO-92		0.9	W
	TO-92NL			
Junction Temperature		T_J	+150	$^\circ\text{C}$
Storage Temperature		T_{STG}	-55 ~ +150	$^\circ\text{C}$

Notes: 1. Absolute maximum ratings are those values beyond which the device could be permanently damaged.

Absolute maximum ratings are stress ratings only and functional device operation is not implied.

2. $P_W \leq 10\text{ms}$, Duty cycle $\leq 20\%$.

■ ELECTRICAL CHARACTERISTICS ($T_A=25^\circ\text{C}$, unless otherwise specified)

PARAMETER	SYMBOL	TEST CONDITIONS	MIN	TYP	MAX	UNIT
Collector to Base Breakdown Voltage	BV_{CBO}	$I_C=10\mu\text{A}$, $I_E=0$	120			V
Collector to Emitter Breakdown Voltage	BV_{CEO}	$I_C=1\text{mA}$, $R_{BE}=\infty$	80			V
Emitter to Base Breakdown Voltage	BV_{EBO}	$I_E=10\mu\text{A}$, $I_C=0$	6			V
Collector Cutoff Current	I_{CBO}	$V_{CB}=120\text{V}$, $I_E=0$			500	nA
Emitter Cutoff Current	I_{EBO}	$V_{EB}=6\text{V}$, $I_C=0$			500	nA
DC Current Transfer Ratio	h_{FE1}	$V_{CE}=5\text{V}$, $I_C=150\text{mA}$	60		320	
	h_{FE2}	$V_{CE}=5\text{V}$, $I_C=500\text{mA}$	40			
Collector to Emitter Saturation Voltage	$V_{CE(SAT)}$	$I_C=500\text{mA}$, $I_B=50\text{mA}$			0.5	V
Base to Emitter Saturation Voltage	$V_{BE(SAT)}$	$I_C=500\text{mA}$, $I_B=50\text{mA}$			1.1	V
Gain Bandwidth Product	f_T	$V_{CE}=-5\text{V}$, $I_C=-150\text{mA}$		140		MHz
Collector Output Capacitance	C_{ob}	$V_{CB}=-10\text{V}$, $I_E=0$, $f=1\text{MHz}$		20		pF

■ CLASSIFICATION OF h_{FE1}

RANK	B	C	D
RANGE	60-120	100-200	160-320

■ TYPICAL CHARACTERISTICS

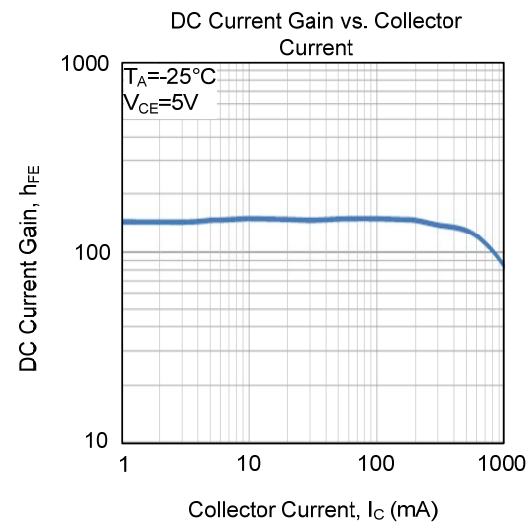
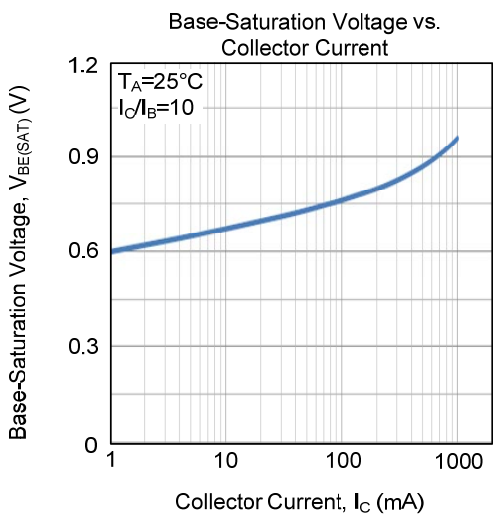
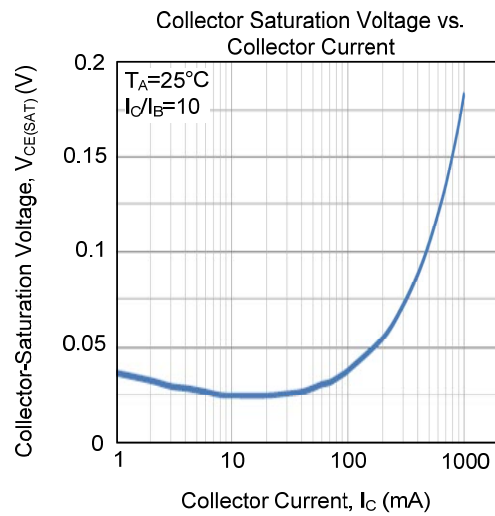
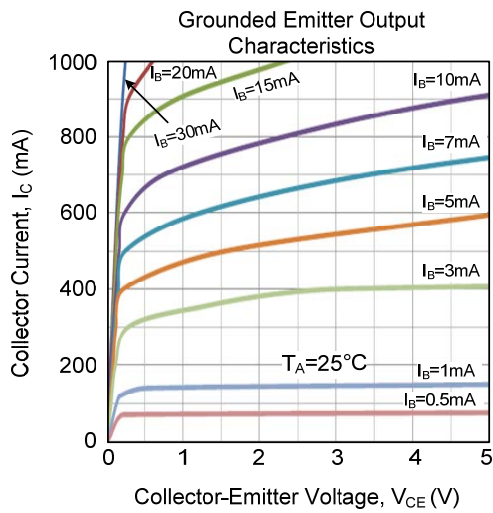

UTC assumes no responsibility for equipment failures that result from using products at values that exceed, even momentarily, rated values (such as maximum ratings, operating condition ranges, or other parameters) listed in products specifications of any and all UTC products described or contained herein. UTC products are not designed for use in life support appliances, devices or systems where malfunction of these products can be reasonably expected to result in personal injury. Reproduction in whole or in part is prohibited without the prior written consent of the copyright owner. UTC reserves the right to make changes to information published in this document, including without limitation specifications and product descriptions, at any time and without notice. This document supersedes and replaces all information supplied prior to the publication hereof.