

WNM6008

Single N-Channel, 80V, 93A, Power MOSFET

<http://www.omnivision-group.com/>

V_{DS} (V)	Max. $R_{DS(on)}$ (m Ω)
80	4.0 @ $V_{GS}=10V$
	6.7 @ $V_{GS}=6V$

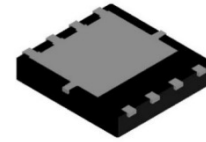

PDFN5X6-8L

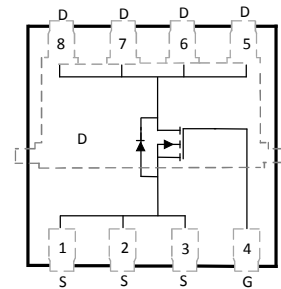

Pin configuration (Top view)

Description

The WNM6008 is N-Channel enhancement MOS Field Effect Transistor. Uses advanced trench technology and design to provide excellent $R_{DS(ON)}$ with low gate charge. This device is suitable for use in DC-DC conversion, power switch and charging circuit. Standard Product WNM6008 is in compliance with RoHS.

Features

- Trench Technology
- Super high density cell design
- Low ON resistance
- Package PDFN5X6-8L

Applications

- DC/DC converters
- Power supply converters circuit
- Load/Power Switching for portable device

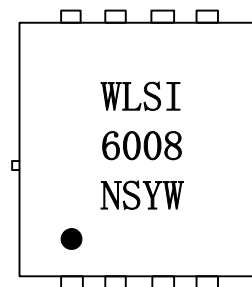

WLSI = Company Code

6008 = Device Code

NS = Special Code

Y = Year

W = Week(A~z)

Marking

Order information

Device	Package	Shipping
WNM6008-8/TR	PDFN5X6-8L	3000/Tape&Reel

Absolute Maximum ratings

Parameter	Symbol	Maximum	Unit
Drain-Source Voltage	V_{DS}	80	V
Gate-Source Voltage	V_{GS}	± 20	
Continuous Drain Current	I_D	$T_C=25^\circ\text{C}$	93
		$T_C=100^\circ\text{C}$	59
Pulsed Drain Current ^c	I_{DM}	275	A
Continuous Drain Current	I_{DSM}	$T_A=25^\circ\text{C}$	30
		$T_A=70^\circ\text{C}$	24
Avalanche Energy $L=0.3\text{mH}$	E_{AS}	158	mJ
Power Dissipation ^b	P_D	$T_C=25^\circ\text{C}$	63
		$T_C=100^\circ\text{C}$	25
Power Dissipation ^d	P_{DSM}	$T_A=25^\circ\text{C}$	6.3
		$T_A=70^\circ\text{C}$	4.0
Operating Junction Temperature	T_J	-55 to 150	$^\circ\text{C}$
Storage Temperature Range	T_{STG}	-55 to 150	$^\circ\text{C}$

Thermal resistance ratings

Single Operation					
Parameter		Symbol	Typical	Maximum	Unit
Junction-to-Ambient Thermal Resistance ^a	$t \leq 10\text{ s}$	$R_{\theta JA}$	16	20	$^\circ\text{C/W}$
	Steady State		41	50	
Junction-to-Case Thermal Resistance	Steady State	$R_{\theta JC}$	1.5	2.0	

Note:

- a FR-4 board (38mm X 38mm X t1.6mm, 70um Copper) partially covered with copper (645mm² area).
- b The power dissipation P_D is based on $T_{J(MAX)}=150^\circ\text{C}$, using junction-to-case thermal resistance, and is more useful in setting the upper dissipation limit for cases where additional heat sinking is used.
- c Repetitive rating, $\sim 10\mu\text{s}$ pulse width, duty cycle $\sim 1\%$, keep initial $T_J = 25^\circ\text{C}$, the maximum allowed junction temperature of 150°C .
- d The power dissipation P_{DSM} is based on Junction-to-Ambient thermal resistance $R_{\theta JA}$ $t \leq 10\text{s}$ value and the $T_{J(MAX)}=150^\circ\text{C}$.
- e The static characteristics are obtained using $\sim 380\mu\text{s}$ pulses, duty cycle $\sim 1\%$.

Electronics Characteristics (Ta=25°C, unless otherwise noted)

Parameter	Symbol	Test Conditions	Min	Typ	Max	Unit
OFF CHARACTERISTICS						
Drain-to-Source Breakdown Voltage	BV_{DSS}	$V_{GS} = 0\text{ V}, I_D = 250\mu\text{A}$	80			V
Zero Gate Voltage Drain Current	I_{DSS}	$V_{DS} = 64\text{V}, V_{GS} = 0\text{V}$			1	μA
Gate-to-source Leakage Current	I_{GSS}	$V_{DS} = 0\text{ V}, V_{GS} = \pm 20\text{V}$			± 100	nA
ON CHARACTERISTICS						
Gate Threshold Voltage	$V_{GS(TH)}$	$V_{GS} = V_{DS}, I_D = 250\mu\text{A}$	2	3	4	V
Drain-to-source On-resistance	$R_{DS(on)}$	$V_{GS} = 10\text{V}, I_D = 15\text{A}$		3.1	4.0	$\text{m}\Omega$
Drain-to-source On-resistance	$R_{DS(on)}$	$V_{GS} = 6\text{V}, I_D = 10\text{A}$		4.6	6.7	$\text{m}\Omega$
CHARGES, CAPACITANCES AND GATE RESISTANCE						
Input Capacitance	C_{ISS}	$V_{GS} = 0\text{V}, f = 1.0\text{MHz},$ $V_{DS} = 40\text{ V}$		2865		pF
Output Capacitance	C_{OSS}			755		
Reverse Transfer Capacitance	C_{RSS}			26.8		
Total Gate Charge	$Q_{G(TOT)}$	$V_{GS} = 10\text{ V}, V_{DS} = 40\text{V},$ $I_D = 15\text{A}$		49		nC
Threshold Gate Charge	$Q_{G(TH)}$			9.0		
Gate-to-Source Charge	Q_{GS}			12.5		
Gate-to-Drain Charge	Q_{GD}			13.0		
Gate Resistance	R_g	$f=1\text{MHz}$		1.1		Ω
SWITCHING CHARACTERISTICS						
Turn-On Delay Time	$t_d(ON)$	$V_{GS} = 10\text{ V}, V_{DS} = 40\text{ V},$ $R_G=4.7\Omega, I_D=15\text{A}$		15.0		ns
Rise Time	t_r			38.0		
Turn-Off Delay Time	$t_d(OFF)$			34.4		
Fall Time	t_f			21.4		
BODY DIODE CHARACTERISTICS						
Forward Voltage	V_{SD}	$V_{GS} = 0\text{ V}, I_S = 1\text{A}$		0.7	1.2	V

Typical Characteristics (Ta=25°C, unless otherwise noted)

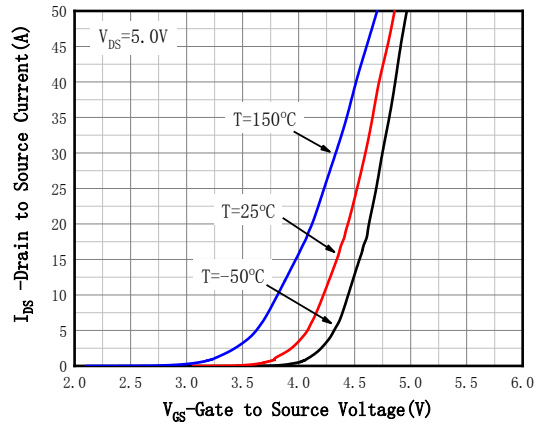
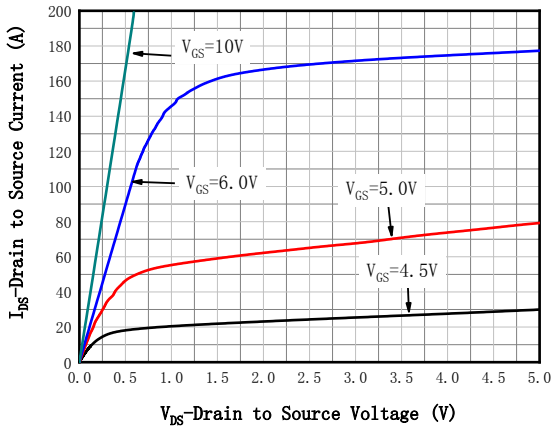

Output Characteristics

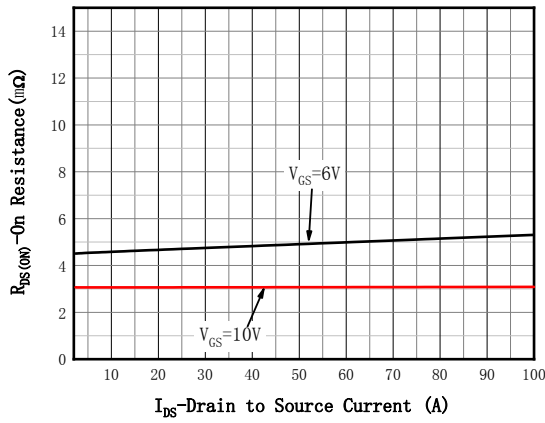

Transfer Characteristics

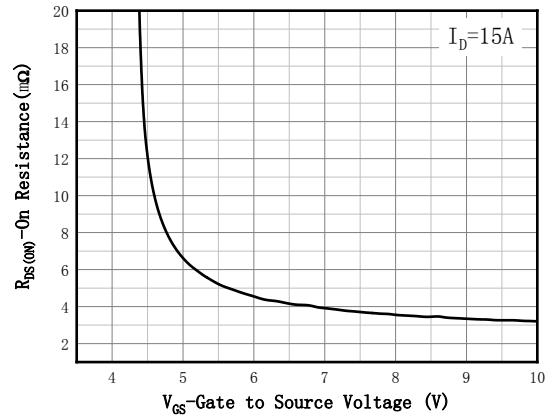

On-Resistance vs. Drain Current

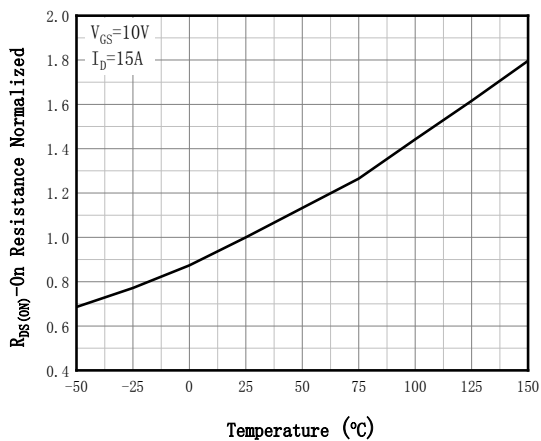

On-Resistance vs. Gate-to-Source Voltage

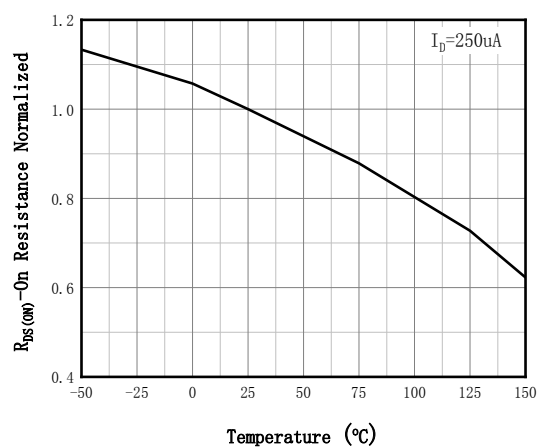

On-Resistance vs. Junction Temperature^e

Threshold Voltage vs. Temperature

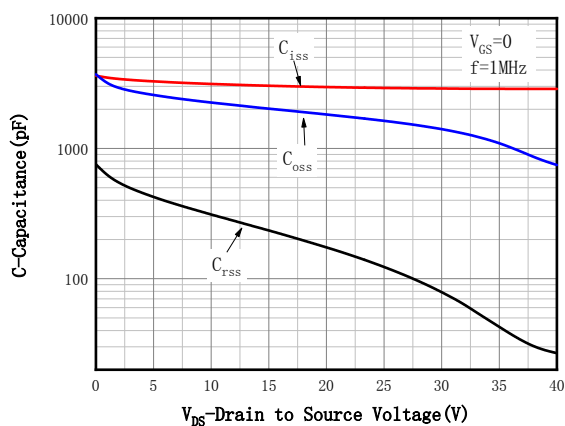

Capacitance

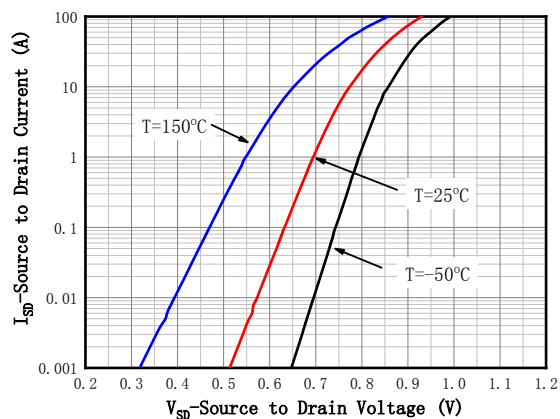

Body Diode Forward Voltage^e

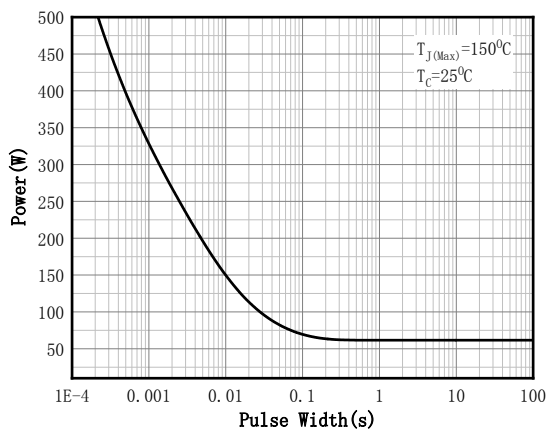

Single Pulse power

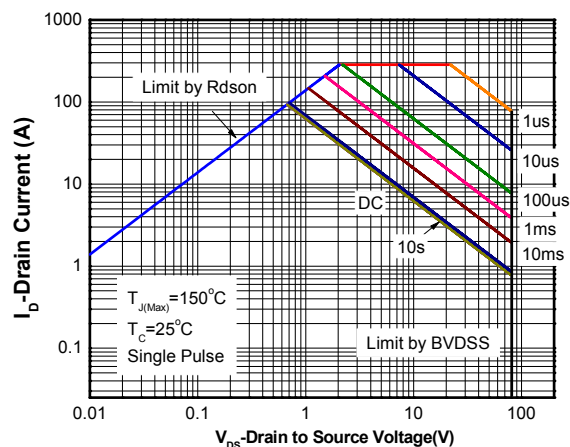

Safe Operating Power

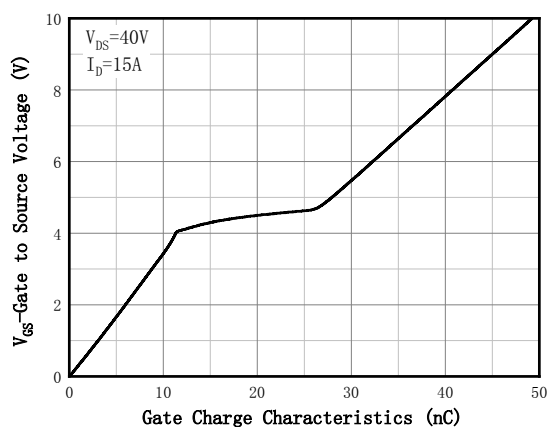

Gate Charge Characteristics

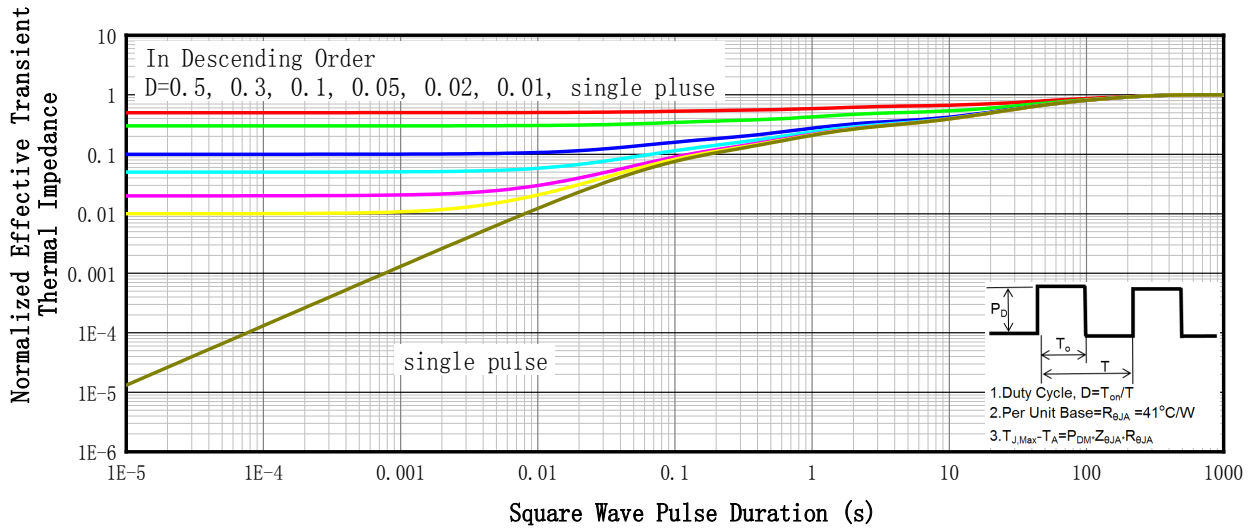

Transient Thermal Response (Junction-to- Ambient)

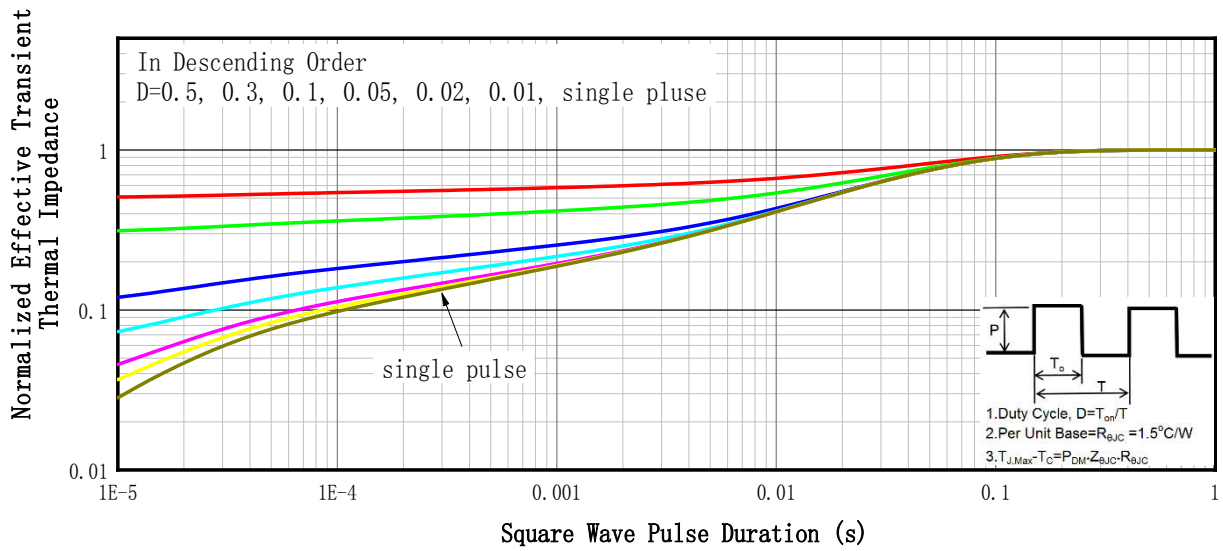

Transient Thermal Response (Junction-to-Case)

PACKAGE OUTLINE DIMENSIONS

PDFN5x6-8L

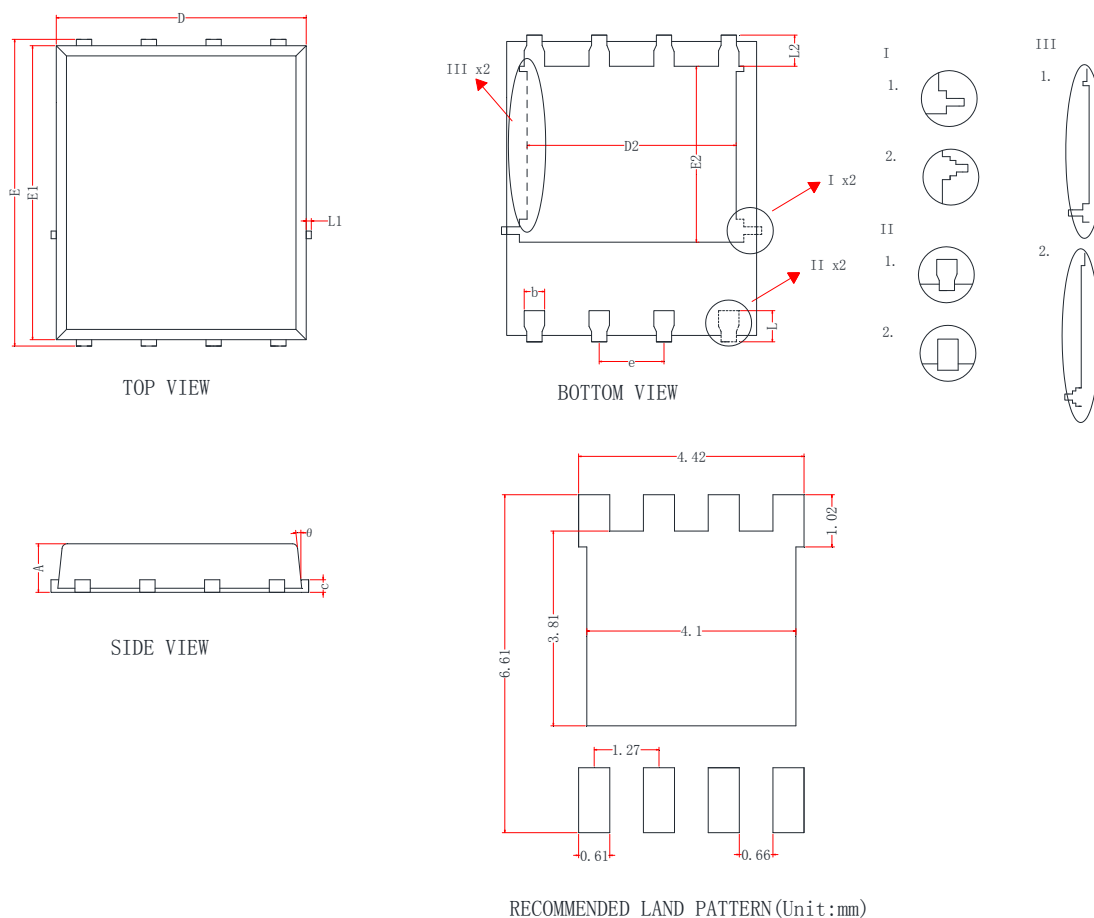

Symbol	Dimensions in Millimeters		
	Min.	Typ.	Max.
A	0.85	0.95	1.00
c	0.15	-	0.34
D	4.80	-	5.30
D2	3.82	-	4.45
E	5.90	-	6.15
E1	5.45	-	5.80
E2	3.18	3.45	3.73
e	1.27BSC		
b	0.30	0.40	0.50
L	0.45	-	0.71
L1	0.00	-	0.15
L2	0.68Ref		
θ	0°	-	12°

TAPE AND REEL INFORMATION

Reel Dimensions

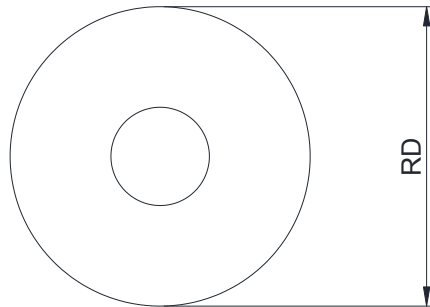

Tape Dimensions

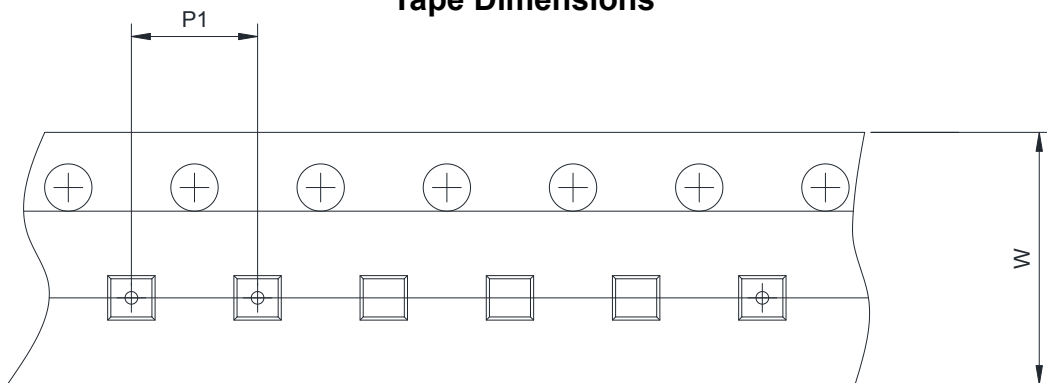

Quadrant Assignments For PIN1 Orientation In Tape

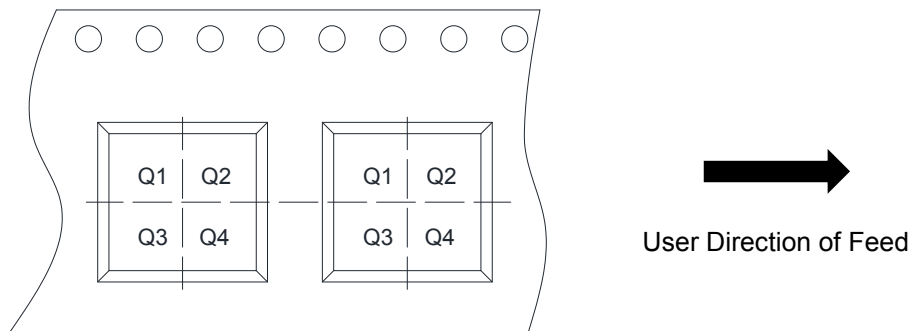

RD	Reel Dimension	<input type="checkbox"/> 7inch	<input checked="" type="checkbox"/> 13inch
W	Overall width of the carrier tape	<input type="checkbox"/> 8mm	<input checked="" type="checkbox"/> 12mm <input type="checkbox"/> 16mm
P1	Pitch between successive cavity centers	<input type="checkbox"/> 2mm	<input type="checkbox"/> 4mm <input checked="" type="checkbox"/> 8mm
Pin1	Pin1 Quadrant	<input checked="" type="checkbox"/> Q1	<input type="checkbox"/> Q2 <input type="checkbox"/> Q3 <input type="checkbox"/> Q4