

LUCKI CM ELECTRONICS Co.,Ltd



- Features
 - 2.0 x 1.6 x 0.45 MAX. mm of surface mounted quartz crystal units.
 - Excellent reliability characteristics such as heat and mechanical shock.
 - Pb-free and satisfy Ro Hs requirements.
 - Reflow soldering is available.

- Applications
 - Digital Electronics, Consumer Products, Mobile Communications, Bluetooth, Wireless LAN and Automotive

■ Specifications

LK P/N	L214S240L11L
Nominal Frequency	24.000 MHz
Oscillation Mode	<input checked="" type="checkbox"/> Fundamental <input type="checkbox"/> 3rd
Frequency tolerance at 25°C	±10 ppm
Operating temperature range and frequency stability	-40°C~+85°C/±20ppm
Equivalent series resistance	50 Ω
Shunt capacitance	2 pF Max or specify
Load capacitance	12 pF
Drive level (Max.)	10, 100, 300 μW or specify
Insulation resistance	500MΩ Min. at DC 100V
Aging at 25°C	± 2 ppm / year Max
Storage temperature range	-40 ~ +125 °C
Measure instrument	S&A 250B system with PI circuit
Others	

■ Dimensions (unit: mm)

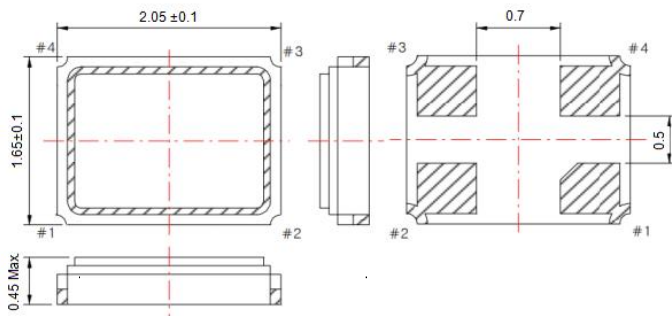

■ Land pattern (unit: mm)

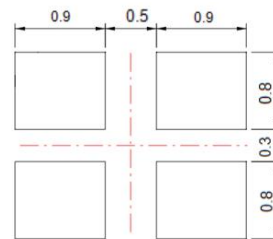

Pin	Function
#1	Xtal Terminal (Input)
#2	GND
#3	Xtal Terminal (Output)
#4	GND