

修订 REV	标记 MARK	修改摘要 REVISION DESCRIPTION	签名 SIGNATURE	日期 DATE
A0		NEW DWG		2014-07-07

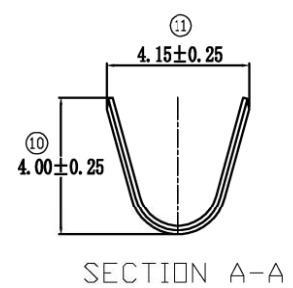
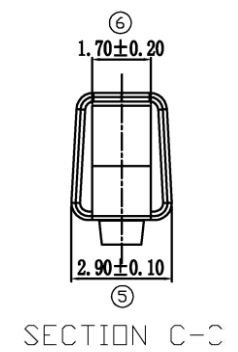
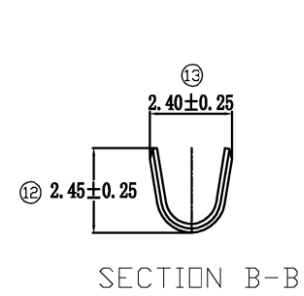
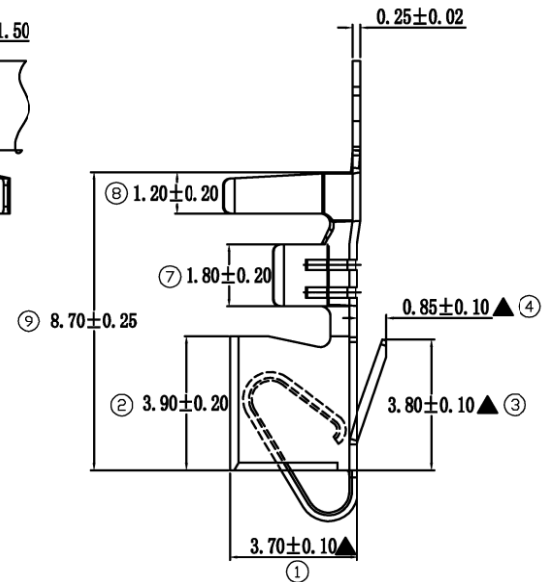
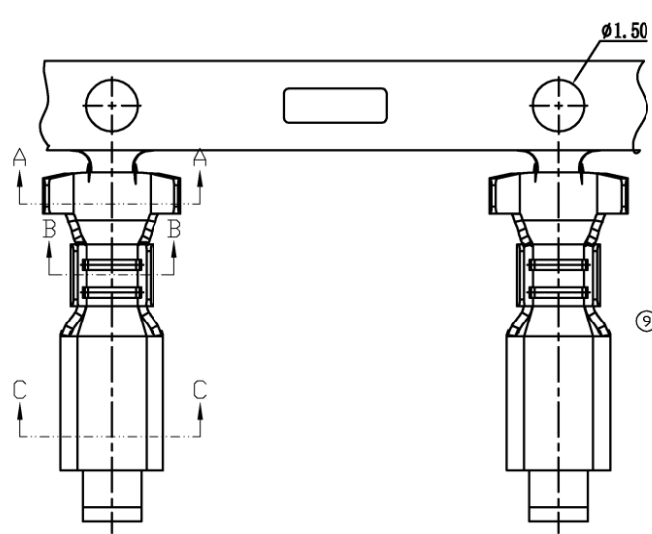

- 产品要求
1. 材质要求: 磷铜, C5191; T=0.25±0.02MM
 2. 电镀要求 先冲后镀 镀镍 Ni底

		深圳市华德共创科技有限公司 Shenzhen Huade co-create Technology Co., LTD 电话: 0755-27129737 传真: 0755-29940187						
		-TOLERANCES- UNLESS OTHERWISE SPECIFIED 公差参数表				TITLE: 产品名称: VH3.96-T		
X.X	±0.30	X.X'	±3'	APPD: 核准: 谢亮	PART NO: 产品编号: HDGC3963-T			
X.XX	±0.30	X.XX'	±2'	CHECK: 校对: 王建业	DATE	SCALE	UNIT	CODE NUMBER
X.XXX	±0.10	X.XXX'	±1'	DRAW: 绘图: 黄艳兰	2014-07-07	1:1	mm	A001

修订 REV	标记 MARK	修改摘要 REV DESCRIPTION	签名 SIGNATURE	日期 DATE
A0		NEW DWG		2014-11-12

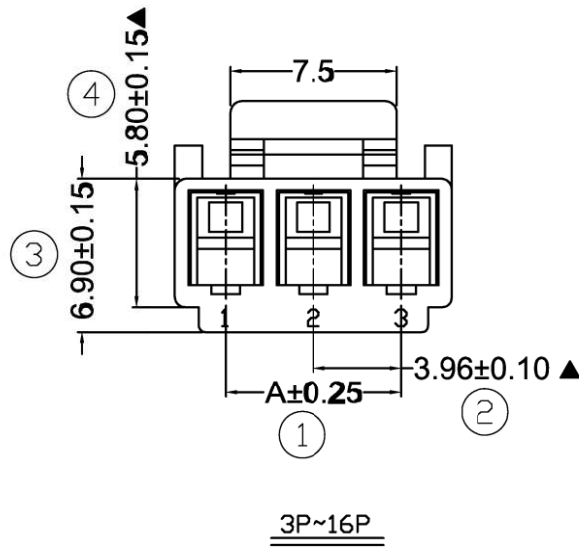
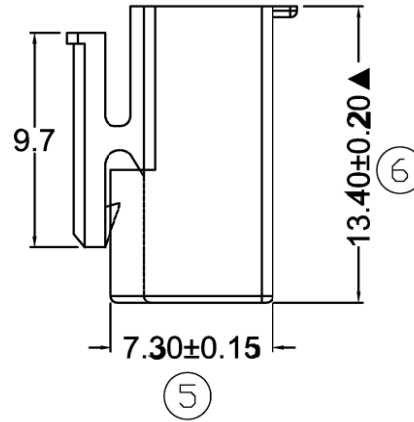
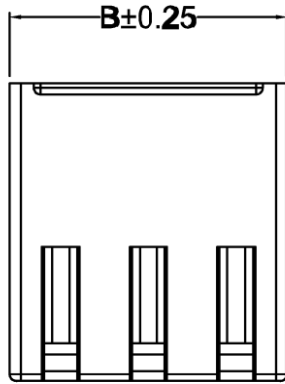
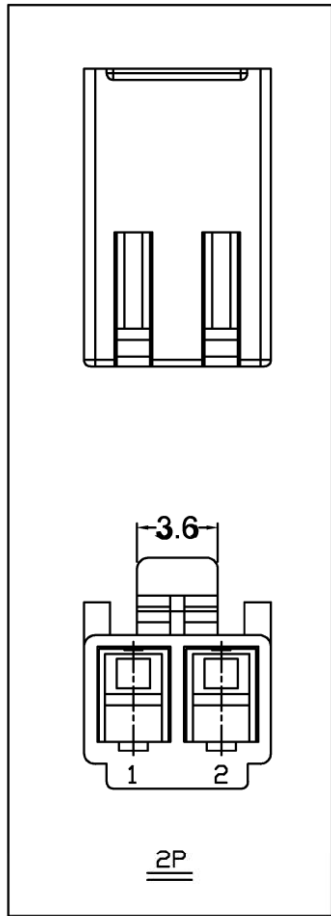

16	HDGC3963H-16P	59.40	64.00
15	HDGC3963H-15P	55.44	60.04
14	HDGC3963H-14P	51.48	56.08
13	HDGC3963H-13P	47.52	52.12
12	HDGC3963H-12P	43.56	48.16
11	HDGC3963H-11P	39.60	44.20
10	HDGC3963H-10P	35.64	40.24
9	HDGC3963H-9P	31.68	36.28
8	HDGC3963H-8P	27.72	32.32
7	HDGC3963H-7P	23.76	28.36
6	HDGC3963H-6P	19.80	24.40
5	HDGC3963H-5P	15.84	20.44
4	HDGC3963H-4P	11.88	16.48
3	HDGC3963H-3P	7.92	12.52
2	HDGC3963H-2P	3.96	8.56
Circuits	Part No.	Dimension(mm)	
		A	B

产品要求:

- 1、材质要求: PA66 UL 94-V0。
- 2、外观要求: 外观无变形、缺胶, 披锋≤0.08mm。
- 3、尺寸要求: 全尺寸符合检测标准, ▲为重点尺寸。

HDGC 深圳市华德共创科技有限公司
Shenzhen Huade co-create Technology Co., LTD
电话: 0755-27129737 传真: 0755-29940187

-TOLERANCES- UNLESS OTHERWISE SPECIFIED 公差参数表		TITLE: 产品名称: VH3.96H-XP	
X.X ± 0.30	X.X° ± 3°	APPD: 核准: 谢亮	PART NO: 产品编号: HDGC3963H-XP
X.XX ± 0.20	X.XX° ± 2°	CHECK: 校对: 王建业	DATE SCALE UNIT CODE NUMBER
X.XXX ± 0.10	X.XXX° ± 1°	DRAW: 绘图: 黄艳兰	2014-11-12 1:1 mm A006