

修订 REV	标记 MARK	修改摘要 REVISION DESCRIPTION	签名 SIGNATURE	日期 DATE
A0		NEW DWG		2013-05-07

技术指标:

1. 温度范围:  $-40^{\circ}\text{C} \sim 85^{\circ}\text{C}$ .
2. 额定电压: 200V AC, DC.
3. 耐压: 200V AC/minute.
4. 接触电阻:  $\leq 25\text{m}\Omega$ .
5. 绝缘电阻:  $\geq 1000\text{M}\Omega$ .
6. 额定电流: 2A AC, DC.

CKT	A	B	C
2	2.00	4.50	5.70
3	4.00	6.50	7.70
4	6.00	8.50	9.70
5	8.00	10.50	11.70
6	10.00	12.50	13.70
7	12.00	14.50	15.70
8	14.00	16.50	17.70
9	16.00	18.50	19.70
10	18.00	20.50	21.70
11	20.00	22.50	23.70
12	22.00	24.50	25.70
13	24.00	26.50	27.70
14	26.00	28.50	29.70
15	28.00	30.50	31.70
16	30.00	32.50	33.70

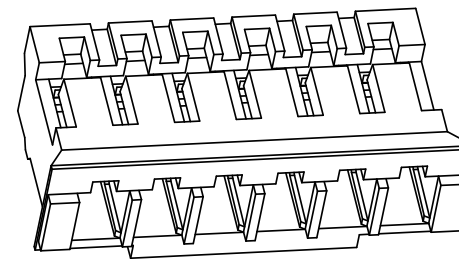
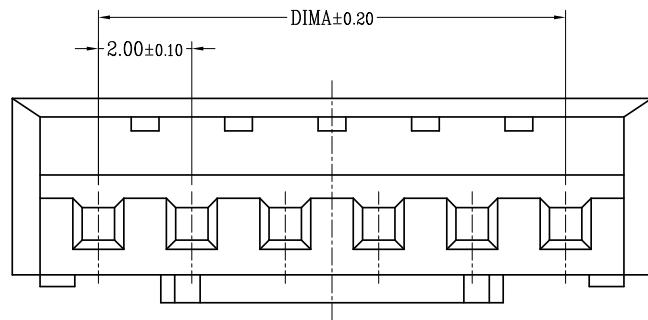
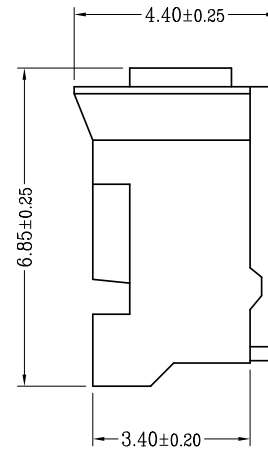
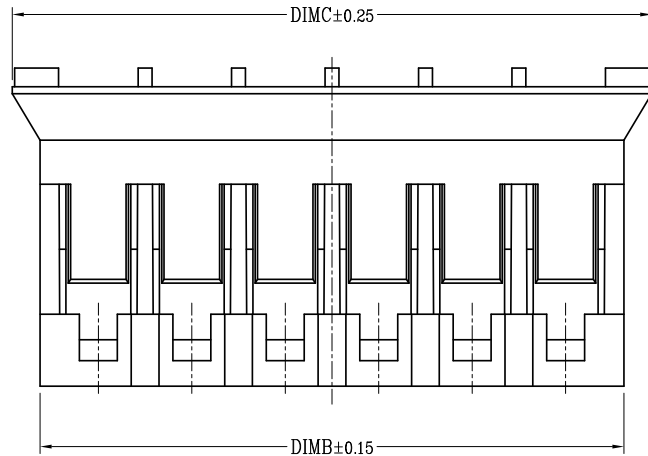

 <b>深圳市华德共创科技有限公司</b> Shenzhen Huade co-create Technology Co., LTD 电话: 0755-27129737 传真: 0755-29940187		TITLE: PH2.0胶壳 产品名称:	
		PART NO: HDGC2001H-XP 产品编号:	
X.X ± 0.30 X.XX ± 0.30 X.XXX ± 0.10	X.X' ± 3° X.XX' ± 2° X.XXX' ± 1°	APPD: 核准: 谢亮 CHECK: 校对: 王建业 DRAW: 绘图: 黄艳兰	DATE: 2013-05-07 SCALE: 1:1 UNIT: mm CODE NUMBER: A003

-TOLERANCES- UNLESS OTHERWISE SPECIFIED 公差参数表	
---	--

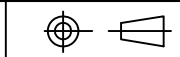

TITLE: PH2.0胶壳			
PART NO: HDGC2001H-XP			
DATE	SCALE	UNIT	CODE NUMBER
2013-05-07	1:1	mm	A003

环保物料

修订 REV	标记 MARK	修改摘要 REVISION DESCRIPTION	签名 SIGNATURE	日期 DATE
A0		NEW DWG		2015-10-09
A1	※	端子倒扣尺寸改低, 以便端子插入塑胶更顺畅		2022-03-11

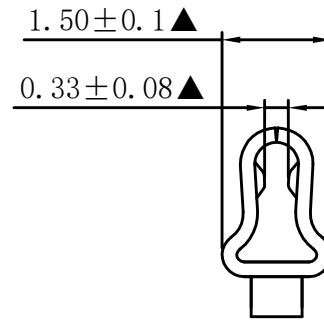
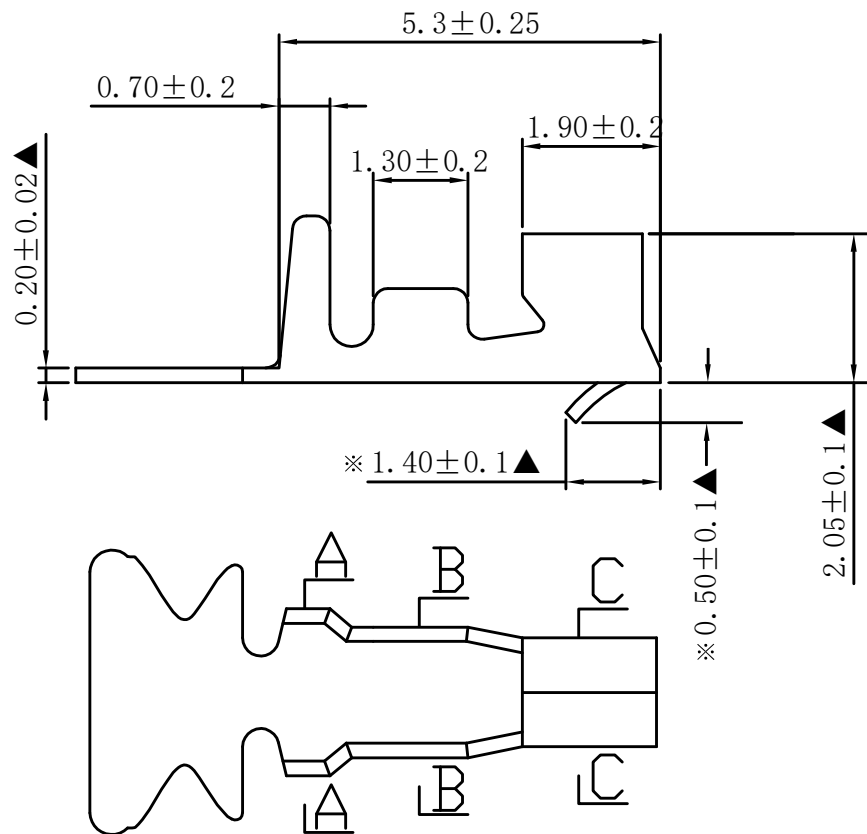

C-C旋转

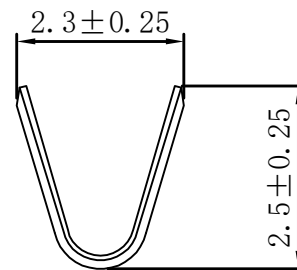

A-A旋转

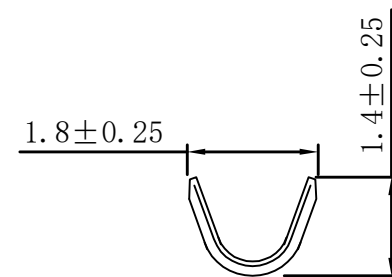

B-B旋转

注明:

- 1: 零件外观要求无毛刺和机械损伤;
- 2: 镀锡镍底, 镀层均匀, 无雾斑;
- 3: ▲为重点尺寸。

		深圳市华德共创科技有限公司 Shenzhen Huade co-create Technology Co., LTD 电话: 0755-27129737 传真: 0755-29940187						
		-TOLERANCES- UNLESS OTHERWISE SPECIFIED 公差参数表				TITLE: 产品名称: PH2.0-TER		
X.	±0.20	X.X*	±3°	APPD: 核准: 谢亮	PART NO: 产品编号: HDGC2001-T			
X.X	±0.15	X.XX*	±2°	CHECK: 校对: 王建国	DATE	SCALE	UNIT	CODE NUMBER
X.XX	±0.08	X.XXX*	±1°	DRAW: 绘图: 黄艳兰	2022-03-11	1:1	mm	A001
X.XXX	±0.05							