

修订 REV	标记 MARK	修改摘要 REVISION DESCRIPTION	签名 SIGNATURE	日期 DATE
A0		NEW DWG		2012-11-10

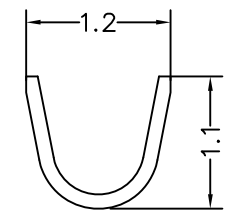

Section A-A

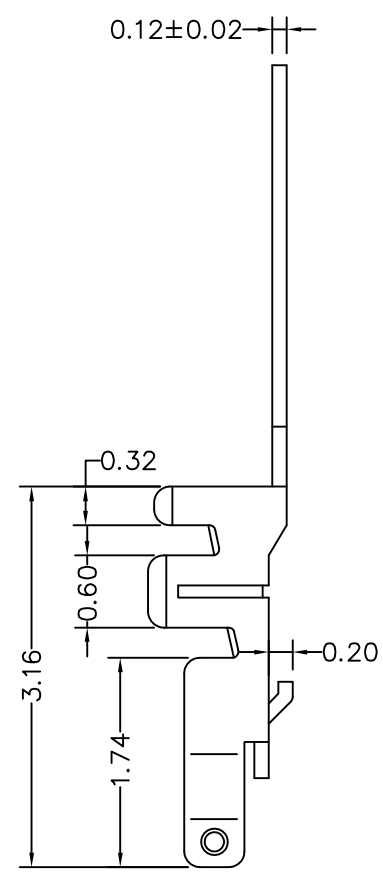
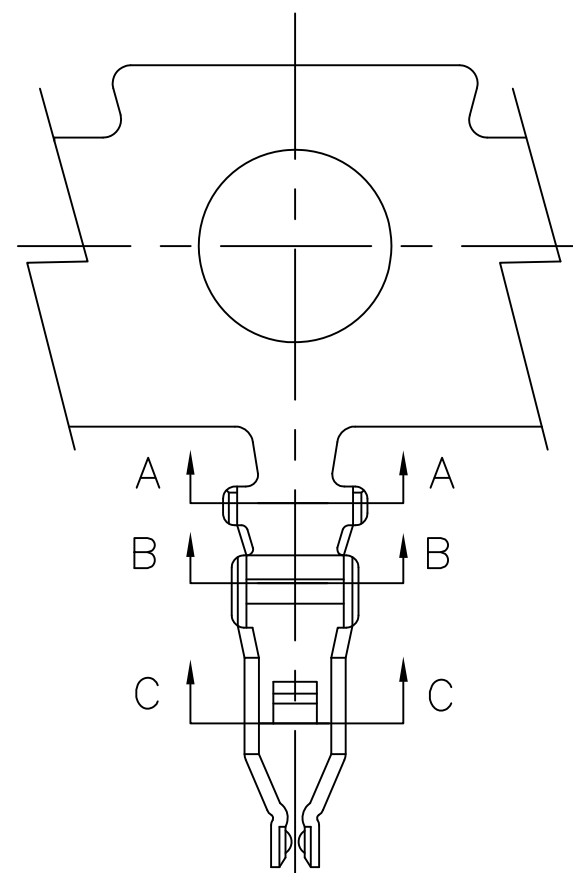
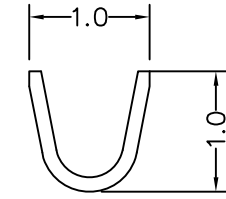

Section B-B

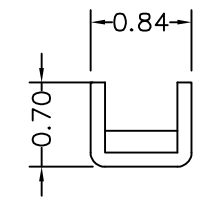

Section C-C

Specification & Ordering Information:

Part No	Wire Range	Insulation O.D.	Material	Finish
HDGC1202-T	AWG #30~#36	0.75mm(max)	Phosphor bronze	Gold over Nickel

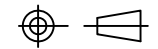
 <b>深圳市华德共创科技有限公司</b> Shenzhen Huade co-create Technology Co.,LTD 电话: 0755-27129737 传真: 0755-29940187		TITLE: 产品名称: <b>MX1.2-T</b>	
-TOLERANCES- UNLESS OTHERWISE SPECIFIED 公差参数表			
X.X ± 0.30	X.X° ± 3°	APPD: 核准: 谢亮	PART NO: 产品编号: <b>HDGC1202-T</b>
X.XX ± 0.30	X.XX° ± 2°	CHECK: 校对: 王建业	DATE SCALE UNIT CODE NUMBER
X.XXX ± 0.10	X.XXX° ± 1°	DRAW: 绘图: 黄艳兰	2012-11-10 1:1 mm A001