

■ Metal Alloy Low Resistance Chip Resistor — MA Series

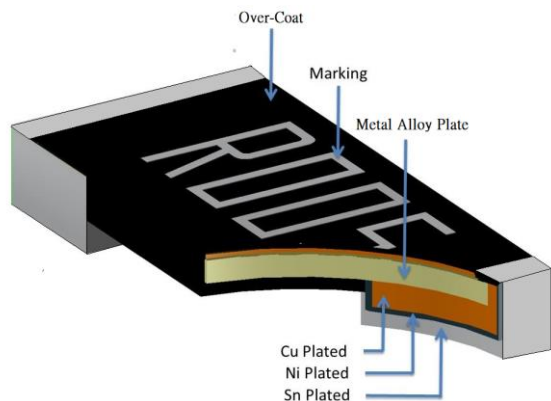

■ Application

- Entertainment product
- Power supply
- Measuring instrument
- Industrial product
- Battery management system

■ Features

- Low Resistance / Low TCR
- Excellent long term stability
- RoHs compliant and halogen free.
- Lead free.
- High precision current sensing and voltage division.

■ Parts Number Explanation

■ Example:

MA	2512	20	F	R001	M	Z
Product Type	Size (Inch)	Rated Power	Tolerance	Resistance	Material	Optional
	1206 2512 2725 2728 4527	05= 0.5W 07= 0.75 W 10= 1.00 W 15= 1.50 W 20= 2.00 W 30= 3.00 W 40= 4.00 W 50= 5.00 W	D : ±0.5 % F : ±1 % G : ±2 % J : ±5 %	0m20= 0.2 mR 2m50= 2.5 mR R000= 0 mR R005= 5.0 mR R100= 100 mR R500= 500 mR	S : MnCuSn M : MnCu F : FeCrAl C : Cu	Z : Default code



MA Series Metal Alloy Low-Resistance Resistor Product Specifications

Document No.	S-10-12-05-28
Revision Date	2022/08/18
Page No.	2/10

Standard Electrical Specifications

TYPE	Rating Power at 70°C	T.C.R. (ppm/°C)	Max. Rating Current	Max. Overload Current	Resistance Range (mΩ)		Material	Operating Temperature Range (°C)	
					0.5% (D)	1.0% (F) 2.0% (G) 5.0% (J)			
MA1206	0.5W	≤±50	22.36	50.00	5~75	1~75	R001 : MnCuSn R002~R007 : MnCu R008~R075 : FeCrAl	-55~+170°C	
	0.75W		27.38	61.23					
	1W		31.62	70.71	5~50	1~50			R001 : MnCuSn R002~R007 : MnCu R008~R050 : FeCrAl
	1.5W		38.72	86.60	5~10	1~10			R001 : MnCuSn R002~R007 : MnCu R008~R010 : FeCrAl
MA2512	1W	≤±75	44.72	100.00	---	0.5~0.75	R0005~R00075 : MnCuSn		
	1W	≤±50	31.62	70.71	5~450	1~500	R001~R006 : MnCu R007~R500 : FeCrAl		
	2W	≤±75	63.24	141.42	---	0.5~0.75	R0005~R00075 : MnCuSn		
	2W	≤±50	44.72	100.00	5~450	1~450	R001~R006 : MnCu R007~R450 : FeCrAl		
	3W	≤±75	77.45	173.20	---	0.5~0.75	R0005~R00075 : MnCuSn		
	3W	≤±50	54.77	122.47	5~100	1~100	R001~R006 : MnCu R007~R100 : FeCrAl		
MA2725	4W	≤±100	141.42	282.84	---	0.2	R0002~R0004 : MnCuSn		
		≤±50	126.49	252.98		0.25~3	R0005~R0025 : MnCu R003 : FeCrAl		
MA2728	4W	≤±50	31.62	63.24	7~450	4~450	R004~R450 : FeCrAl		
MA4527	2W	≤±75	63.24	141.42	---	0.5	R0005 : MnCuSn		
	2W	≤±50	44.72	100.00	5~100	1~100	R001~R040 : MnCu R041~R100 : FeCrAl		
	3W	≤±75	77.45	173.20	---	0.5	R0005 : MnCuSn		
	3W	≤±50	54.77	122.47	5~60	1~60	R001~R040 : MnCu R041~R060 : FeCrAl		
	5W	≤±75	100.00	173.20	---	0.5	R0005 : MnCuSn		
	5W	≤±50	70.71	122.47	5~500	1~500	R001~R040 : MnCu R041~R500 : FeCrAl		



MA Series Metal Alloy Low-Resistance Resistor Product Specifications

Document No.	S-10-12-05-28
Revision Date	2022/08/18
Page No.	3/10

Jumper Specifications

Type	Rating Power at 70°C	Max. Rating Current	Resistance (mΩ)	Material	Operating Temperature Range (°C)
MA1206	1W	70.7A	≤0.2	Jumper : Cu	-55~+170°C
MA2512	2W	100A			
	3W	122A			

Type Dimension

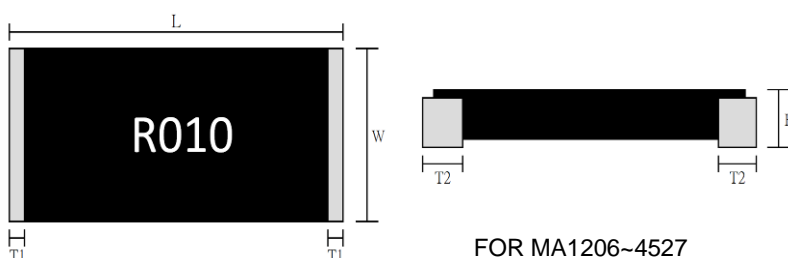

Dimension

Unit : mm

Type	Power Rating	Resistance Range	L	W	H	T1	T2	
MA1206	0.5W 0.75W	1mΩ	3.200±0.254	1.650±0.254	0.820±0.254	0.508±0.254	0.508±0.254	
		2mΩ			0.700±0.254			
		3mΩ			0.600±0.254			
		4~20mΩ			0.550±0.254			
		21~50mΩ			0.470±0.254			
		51~75mΩ			0.400±0.254			
	1W	1mΩ			0.820±0.254			
		2mΩ			0.700±0.254			
		3mΩ			0.600±0.254			
		4~20mΩ			0.550±0.254			
		21~50mΩ			0.470±0.254			
		1.5W			1mΩ			0.820±0.254
					2mΩ			0.700±0.254
					3mΩ			0.600±0.254
					4~10mΩ			0.550±0.254
MA2512	1W	451~500mΩ	6.350±0.254	3.050±0.254	0.350±0.254	0.750±0.254	0.850±0.254	
	1W 2W	0.5mΩ			0.820±0.254	1.980±0.254	2.000±0.254	
		0.75 mΩ			0.700±0.254	1.150±0.254	1.980±0.254	
		1mΩ			0.720±0.254		2.200±0.254	
		1.5mΩ					1.400±0.254	
		2~5mΩ			0.550±0.254	1.150±0.254		
		6mΩ				0.600±0.254		
		7~10mΩ			0.600±0.254	1.050±0.254	1.100±0.254	
		11~75mΩ			0.550±0.254	0.750±0.254		
		76~100mΩ			0.470±0.254			
		101~135mΩ			0.400±0.254			
		136~200mΩ						
		201~450mΩ				0.850±0.254		



MA Series Metal Alloy Low-Resistance Resistor Product Specifications

Document No. S-10-12-05-28
 Revision Date 2022/08/18
 Page No. 4/10

Type	Power Rating	Resistance Range	L	W	H	T1	T2	
MA2512	3W	0.50mΩ	6.350±0.254	3.050±0.254	0.820±0.254	1.980±0.254	2.000±0.254	
		0.75mΩ			0.700±0.254		1.980±0.254	
		1mΩ			0.720±0.254		2.200±0.254	
		1.5mΩ					1.400±0.254	
		2~5mΩ			0.550±0.254	1.150±0.254	1.150±0.254	
		6mΩ				0.75±0.254	1.100±0.254	
		7~10mΩ				1.150±0.254		
		11~75mΩ				0.75±0.254		
76~100mΩ								
MA2725	4W	0.2mΩ	6.900±0.254	6.350±0.254	1.100±0.254	1.20±0.254	2.150±0.254	
		0.25mΩ			0.950±0.254		2.287±0.254	
		0.3mΩ					1.975±0.254	
		0.35mΩ					1.710±0.254	
		0.4mΩ					1.440±0.254	
		0.5mΩ			0.850±0.254		2.080±0.254	
		0.6mΩ	1.780±0.254					
		0.8mΩ	1.300±0.254					
		1mΩ	1.800±0.254					
		1.5~1.6mΩ	6.800±0.254		0.650±0.254	1.15±0.254	1.500±0.254	
2~3mΩ		0.550±0.254						
MA2728	4W	4~450mΩ	6.600±0.254	6.700±0.254	0.580±0.254	0.400±0.254	1.050±0.254	
MA4527	2W	0.5mΩ	11.300±0.500	6.600±0.500	0.770±0.254	0.900±0.254	3.000±0.254	
		1mΩ			0.650±0.254		2.000±0.254	
		1.5~20mΩ					0.550±0.254	
		21~100mΩ						
	3W	0.5mΩ			0.770±0.254	0.900±0.254	3.000±0.254	
		1mΩ					0.650±0.254	2.000±0.254
		1.5~20mΩ						0.550±0.254
		21~60mΩ						
	5W	0.5mΩ			0.800±0.254	0.650±0.254	3.000±0.254	
		1mΩ					0.680±0.254	2.000±0.254
		1.5~20mΩ						0.580±0.254
		21~500mΩ						



MA Series Metal Alloy Low-Resistance Resistor Product Specifications

Document No. S-10-12-05-28

Revision Date 2022/08/18

Page No. 5/10

■ Jumper Dimension

Unit : mm

Type	Power Rating	Resistance Range	L	W	H	T1	T2
MA1206	1W	< 0.2mΩ	3.200±0.254	1.650±0.254	0.650±0.254	0.508±0.254	0.508±0.254
MA2512	2W / 3W	< 0.2mΩ	6.350±0.254	3.050±0.254	0.650±0.254	1.15±0.254	1.100±0.254

■ Performance Characteristics

Power Derating Curve

The Operating Temperature Range: -55°C ~+170°C.

For resistors operated in ambient temperatures above 70°C, power rating must be derating in accordance with the curve below.

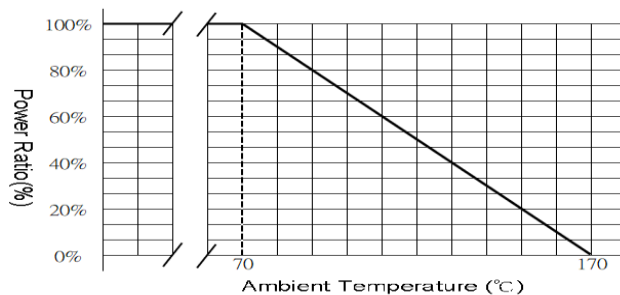

■ Rating Current

The following equation may be used to determine the DC (Direct Current) or AC (Alternating Current) (RMS, root mean square value) of normal rated power. However, if the result value exceeds the highest current of regulated standards, the highest normal rated power is to be used.

$$I = \sqrt{P/R}$$

I = Rating current (A)

P= Rating Power (W)

R= Resistance(Ω)

■ Marking Format:

- All the other products marking are 4 digits.
- “R” designates the decimal location in ohms
 - e.g. 1mΩ the product marking is R001.
 - 25mΩ the product marking is R025.
 - 100mΩ the product marking is R100.
- “m” designates the decimal location in milli-ohms
 - e.g. 0.25mΩ the product marking is 0m25.
 - 0.5mΩ the product marking is 0m50.
 - 5.5mΩ the product marking is 5m50.
 - 25.5mΩ the product marking is 25m5.
- 0Ω product marking is 0R.
- The criteria to distinguishing the mark on the surface of products are that characters can be identified.



MA Series Metal Alloy Low-Resistance Resistor Product Specifications

Document No.	S-10-12-05-28
Revision Date	2022/08/18
Page No.	6/10

Reliability test and requirement

Test Item	Test Method	Procedure	Requirements
Temperature Coefficient of Resistance (T.C.R)	JIS-C-5201-1 4.8 IEC-60115-1 4.8	At 25°C /+150°C, 25°C is the reference temperature	As Spec
Short Time Overload	JIS-C-5201-1 4.13 IEC-60115-1 4.13	The number of rated power are as follows: <ul style="list-style-type: none"> MA1206-0.5W: 5 times of rated power MA1206-0.75W: 5 times of rated power MA1206-1W: 5 times of rated power MA1206-1.5W: 5 times of rated power MA2512-1W: 5 times of rated power MA2512-2W: 5 times of rated power MA2512-3W: 5 times of rated power^(Note) MA2725-4W: 4 times of rated power MA2728-4W: 4 times of rated power MA4527-2W: 5 times of rated power MA4527-3W: 5 times of rated power MA4527-5W: 3 times of rated power for 5 seconds. 	<ul style="list-style-type: none"> MA4527: $\Delta R/R1 \leq \pm 2.0\%$ The others: $\Delta R/R1 \leq \pm 0.5\%$
High Temperature Exposure	JIS-C5201-1 4.25 IEC 60068-2-2	At 170°C for 1000 hours.	<ul style="list-style-type: none"> MA4527: $\Delta R/R1 \leq \pm 2.0\%$ The others: $\Delta R/R1 \leq \pm 1.0\%$
Resistance to Soldering Heat	JIS-C-5201-1 4.18 IEC-60115-1 4.18	260±5°C for 10 seconds.	$\Delta R/R1 \leq \pm 0.5\%$
Temperature Cycling	JESD22 Method JA-104	1000 Cycles (-55°C to +155°C) Measurement at 24±4 hours after test conclusion. 30min maximum dwell time at each temperature extreme.	$\Delta R/R1 \leq \pm 0.5\%$
Biased Humidity	MIL-STD-202 Method 103	1,000 hours; 85°C / 85% RH, 10% of operating power. Measurement at 24±4 hours after test conclusion.	$\Delta R/R1 \leq \pm 0.5\%$
Load Life (Endurance)	JIS-C-5201-1 4.25 IEC-60115-1 4.25.1	70±2°C, RCWV or Max. working voltage whichever is less for 1000 hrs with 1.5 hrs "ON" and 0.5 hr "OFF" .	<ul style="list-style-type: none"> MA4527: $\Delta R/R1 \leq \pm 2.0\%$ The others: $\Delta R/R1 \leq \pm 1.0\%$
Solderability	JIS-C-5201-1 4.17 IEC-60115-1 4.17	245±5°C for 3 seconds.	>95% coverage
Dielectric Withstanding Voltage	JIS-C5201-1 4.7	Applied 500VAC for 1 minute.	No short or burned on the appearance.
Core Body Strength	JIS-C5201-1 4.15	Central part pressurizing force : 5N , 10 seconds	No broken
Terminal Strength (SMD)	AEC Q200-006	Pressurizing force 17.7N for 60 seconds	No broken
Bending Strength	JIS-C-5201-1 4.33 IEC-60115-1 4.33	Bending once 2mm for 10 seconds	$\Delta R/R1 \leq \pm 0.5\%$ No broken
Moisture Resistance	MIL-STD 202 Method 106	T=24 hours / Cycle ,10Cycles . Steps 7a& 7b not required. Unpowered . (Figure 1)	$\Delta R/R1 \leq \pm 0.5\%$

*Note: This test is a destructive experiment. The top protective layer is prone to damage and peculiar smell during, in the 50mR~100mR resistance test. The resistance change rate can meets the specifications.



MA Series Metal Alloy Low-Resistance Resistor Product Specifications

Document No.	S-10-12-05-28
Revision Date	2022/08/18
Page No.	7/10

For Jumper

Test Item	Test Method	Procedure	Requirements
Short Time Overload	JIS-C-5201-1 4.13 IEC-60115-1 4.13	4 times of rated power for 5 seconds.	$\leq 0.2m\Omega$
Temperature Cycling	JESD22 Method JA-104	1000 Cycles (-55°C to +155°C) Measurement at 24±4 hours after test conclusion. 30min maximum dwell time at each temperature extreme.	$\leq 0.2m\Omega$
High Temperature Exposure	JIS-C5201-1 4.25 IEC 60068-2-2	At 170°C for 1000 hours.	$\leq 0.2m\Omega$
Biased Humidity	MIL-STD-202 Method 103	1,000 hours; 85°C / 85% RH, 10% of operating power. Measurement at 24±4 hours after test conclusion.	$\leq 0.2m\Omega$
Load Life (Endurance)	JIS-C-5201-1 4.25 IEC-60115-1 4.25.1	70±2°C, RCWV or Max. working voltage whichever is less for 1000 hrs with 1.5 hrs "ON" and 0.5 hr "OFF" .	$\leq 0.2m\Omega$
Solderability	JIS-C-5201-1 4.17 IEC-60115-1 4.17	245±5°C for 3 seconds.	>95% coverage

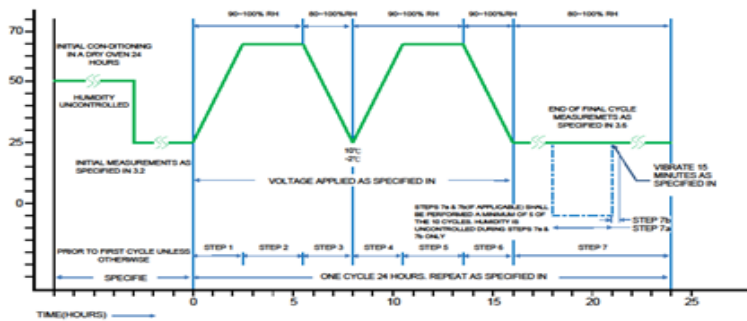
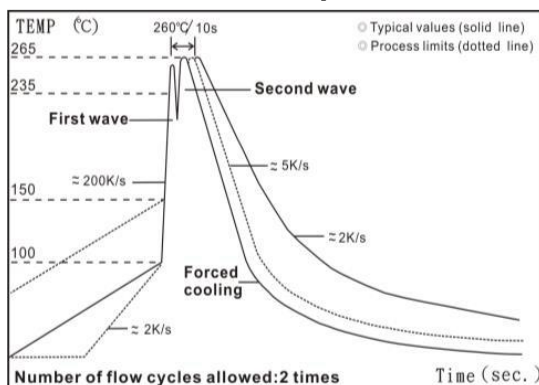

Figure 1

Recommended Customer Soldering Parameters

Wave solder Temperature condition



■ Solder reflow Temperature condition

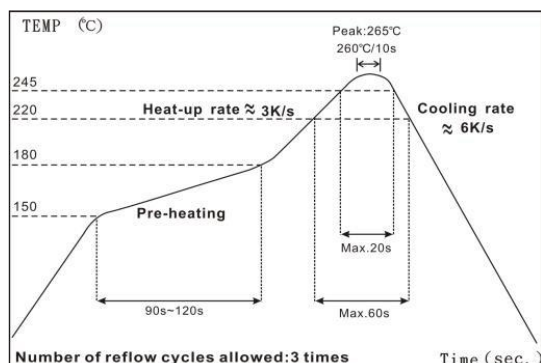

■ Soldering Iron: temperature 350°C±10°C , dwell time shall be less than 3 sec

■ Recommend Land Pattern Design

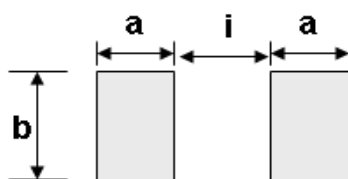

■ Dimension

Unit: mm

TYPE	Resistance Range	a	b	i
MA1206 – 0.5W/0.75W/1W/1.5W	Jumper : ≤0.2mΩ	1.46	2.15	1.68
	1mΩ~75mΩ	1.46	2.15	1.68
MA2512 -1W, 2W, 3W	Jumper : ≤0.2mΩ	2.30	3.68	3.15
	0.5mΩ~1mΩ	3.24	3.68	1.27
	1.5 mΩ	3.20	3.68	1.35
	2~5mΩ	2.60	3.68	2.55
	6mΩ~200mΩ	2.30	3.68	3.15
	201mΩ~500mΩ	2.05	3.68	3.65
MA2725 - 4W	0.2~0.35 mΩ	2.90	6.7	1.28
	0.4~0.8mΩ	3.25	6.85	1.70
	1~3mΩ	2.75	6.85	2.70
MA2728 - 4W	4mΩ~450mΩ	2.05	7.20	3.90
MA4527 – 2W,3W,5W	0.5mΩ~1.5mΩ	4.50	8.74	4.50
	2.0mΩ~100mΩ	3.50	8.74	6.50
	101mΩ~500mΩ	3.50	8.74	6.50



MA Series Metal Alloy Low-Resistance Resistor Product Specifications

Document No.	S-10-12-05-28
Revision Date	2022/08/18
Page No.	9/10

■ Packing Quantity

TYPE	PCS /Reel	Parts Number Explanation
MA1206	5000	Z: 5000PCS
MA1206 R001	4000	Z: 4000PCS
MA2512	4000	Z: 4000PCS
MA2725(R \geq 1)	2000	Z: 2000PCS 1: 1000PCS
MA2725 (0.8 \geq R \geq 0.2)	1000	Z: 1000PCS
MA2728	2000 / 1000	Z: 2000PCS 1: 1000PCS
MA4527	1000 / 500	Z: 1000PCS 0: 500PCS

■ Plating Thickness:

Ni: $\geq 2 \mu\text{m}$

Sn(Tin): $\geq 3 \mu\text{m}$

■ Label :



■ Appendix For SMD Chip Resistor

● Packaging Information

■ Reel Dimensions

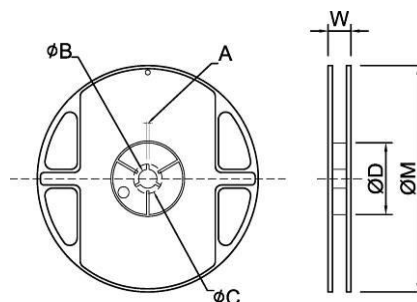



MA Series Metal Alloy Low-Resistance Resistor Product Specifications

Document No.	S-10-12-05-28
Revision Date	2022/08/18
Page No.	10/10

Dimension

Unit: mm

Reel Type / Tape	A	ϕB	ϕC	ϕD	W	ϕM
7" reel for 8 mm embossed (for MA1206)	2.0±0.5	13.2±0.5	17.7±0.5	60.0±0.5	12.0±0.5	178±1.0
7" reel for 12 mm embossed	2.5±0.5	13.5±0.5	17.7±0.5	60.0±0.5	16.2±0.5	178±1.0
7" reel for 24 mm embossed	2.0±0.5	13.2±0.5	17.7±0.5	60.0±0.5	24.4±2.0	178±1.0

Embossed Dimensions

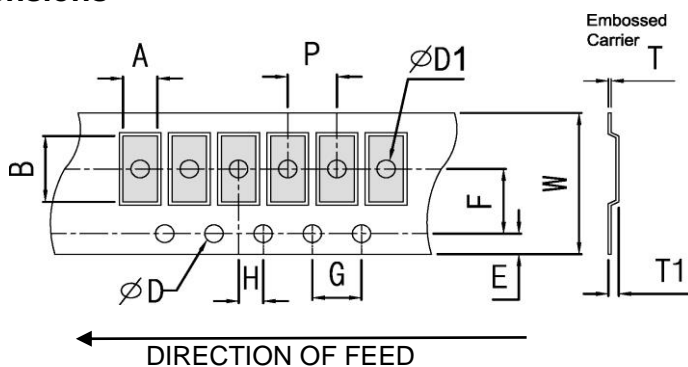

Dimension

Unit: mm

Item	Resistance Range (m Ω)	W	P	E	F	ϕD	$\phi D1$	G	H	A	B	T1	T
MA1206	1m Ω	8.0±0.30	4.0±0.10	1.75±0.10	3.5±0.10	1.50 ^{+0.1} ₀	1.0±0.10	4.0±0.10	2.0±0.10	2.03±0.10	3.55±0.10	1.10±0.10	0.20±0.05
MA1206	2~75m Ω	8.0±0.30	4.0±0.10	1.75±0.10	3.5±0.10		1.0±0.10	4.0±0.10	2.0±0.10	2.03±0.10	3.55±0.10	0.85±0.10	0.20±0.05
MA2512	0.5~1m Ω	12.0±0.30	4.0±0.10	1.75±0.10	5.5±0.10		1.55±0.10	4.0±0.10	2.0±0.10	3.50±0.10	6.75±0.10	1.10±0.10	0.20±0.05
MA2512	2~500m Ω	12.0±0.30	4.0±0.10	1.75±0.10	5.5±0.10		1.55±0.10	4.0±0.10	2.0±0.10	3.50±0.10	6.75±0.10	0.90±0.10	0.20±0.05
MA2725	0.2~0.8m Ω	12.0±0.30	8.0±0.10	1.75±0.10	5.5±0.10		1.55±0.10	4.0±0.10	2.0±0.10	6.81±0.10	7.16±0.10	1.30±0.10	0.25±0.05
MA2725	1~3m Ω	12.0±0.30	8.0±0.10	1.75±0.10	5.5±0.10		1.55±0.10	4.0±0.10	2.0±0.10	6.81±0.10	7.16±0.10	1.05±0.10	0.25±0.05
MA2728	4~450m Ω	12.0±0.30	8.0±0.10	1.75±0.10	5.5±0.10		1.55±0.10	4.0±0.10	2.0±0.10	7.10±0.10	7.05±0.10	0.95±0.10	0.20±0.05
MA4527	0.5~500m Ω	24.0±0.30	12.0±0.10	1.75±0.10	11.5±0.10		1.50±0.10	4.0±0.10	2.0±0.10	7.38±0.10	12.0±0.10	1.05±0.10	0.30±0.10

Storage Temperature

Storage time at the environment temp: 25±5°C & humidity: 60±20% is valid for one year from the date of delivery