

1

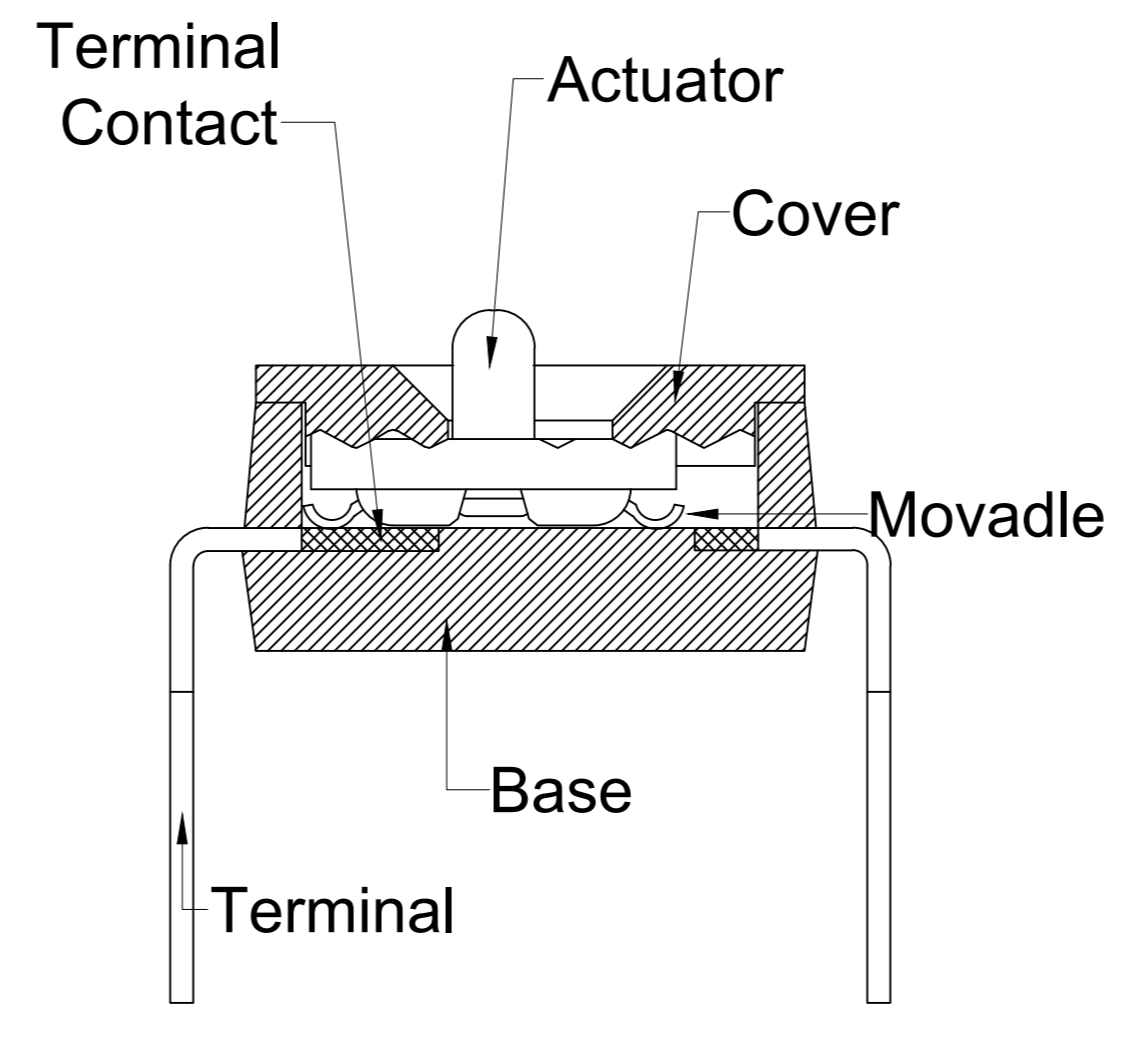

Switching:25mA at 24VDC  
 Non-Switching:100mA at 50VDC  
 Initial:50m Ω Max  
 After life:100mΩ Max  
 Insulation Resistance:100mΩ Min,60 sec at 500VDC  
 Dielectric Strength:500VAC for 60seconds  
 Switch Capacitance:5pF Max at 1MHZ  
 Operation Temperature:-30°C to + 85°C  
 Storage Temperature:-40°C to + 85°C  
 Operation Force:500gf Max  
 Mechanical Life:3000 cycles operations  
 Resistance to Soldering:260±5°C for 3-5 seconds

2

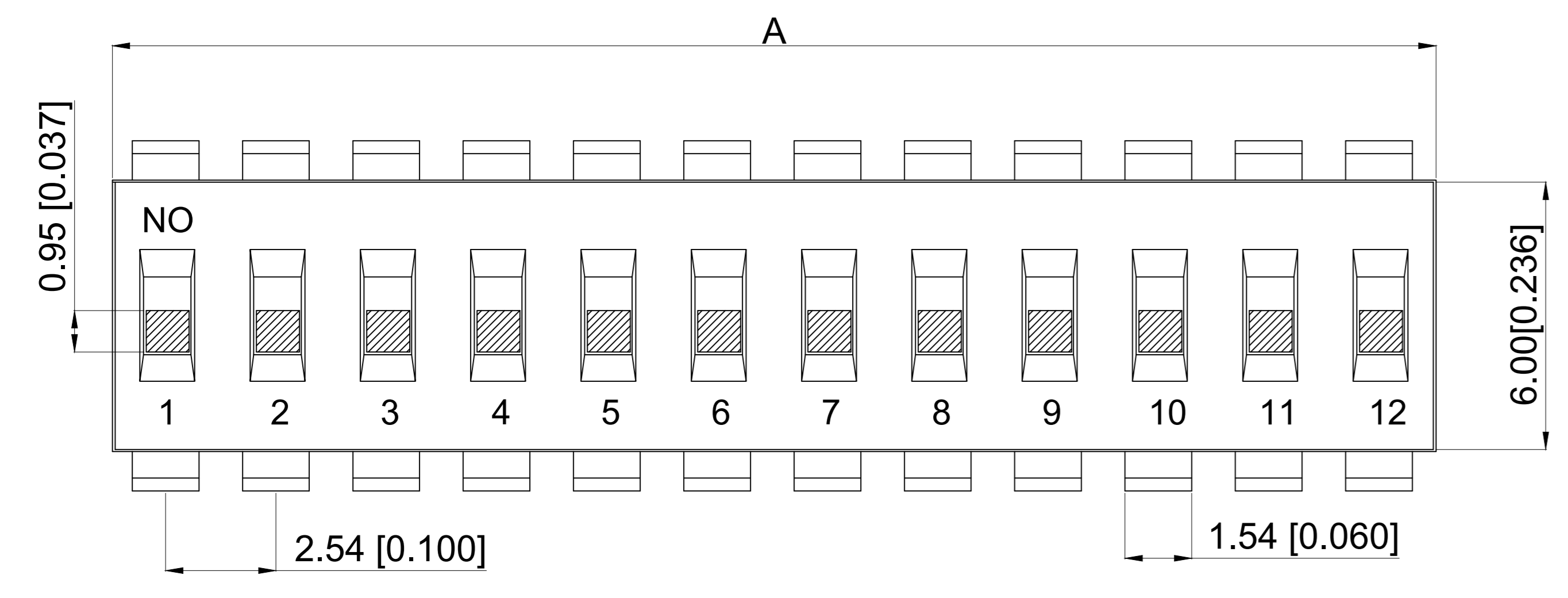
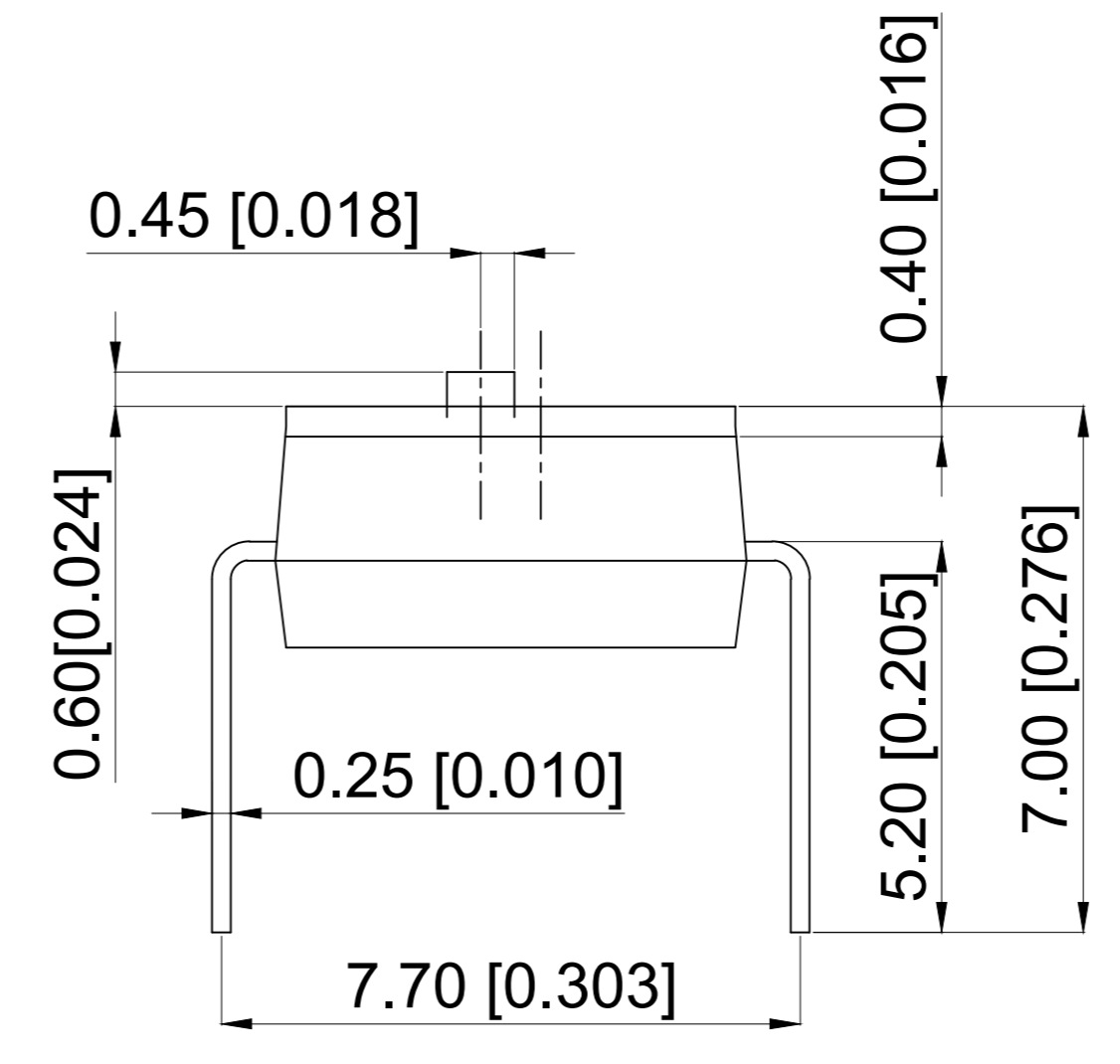
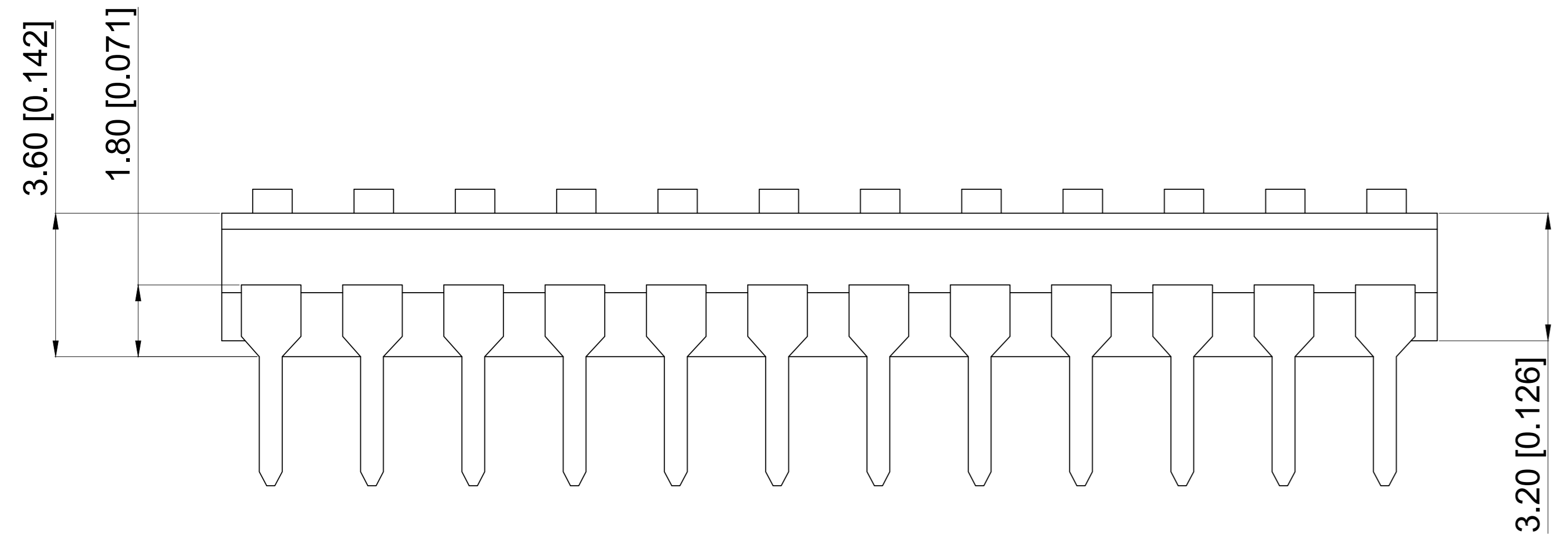

Poles(N)	A Dimension(mm)
01	2.54
02	5.08
03	7.62
04	10.16
05	12.70
06	15.24
07	17.78
08	20.32
09	22.86
10	25.40
12	30.48

3

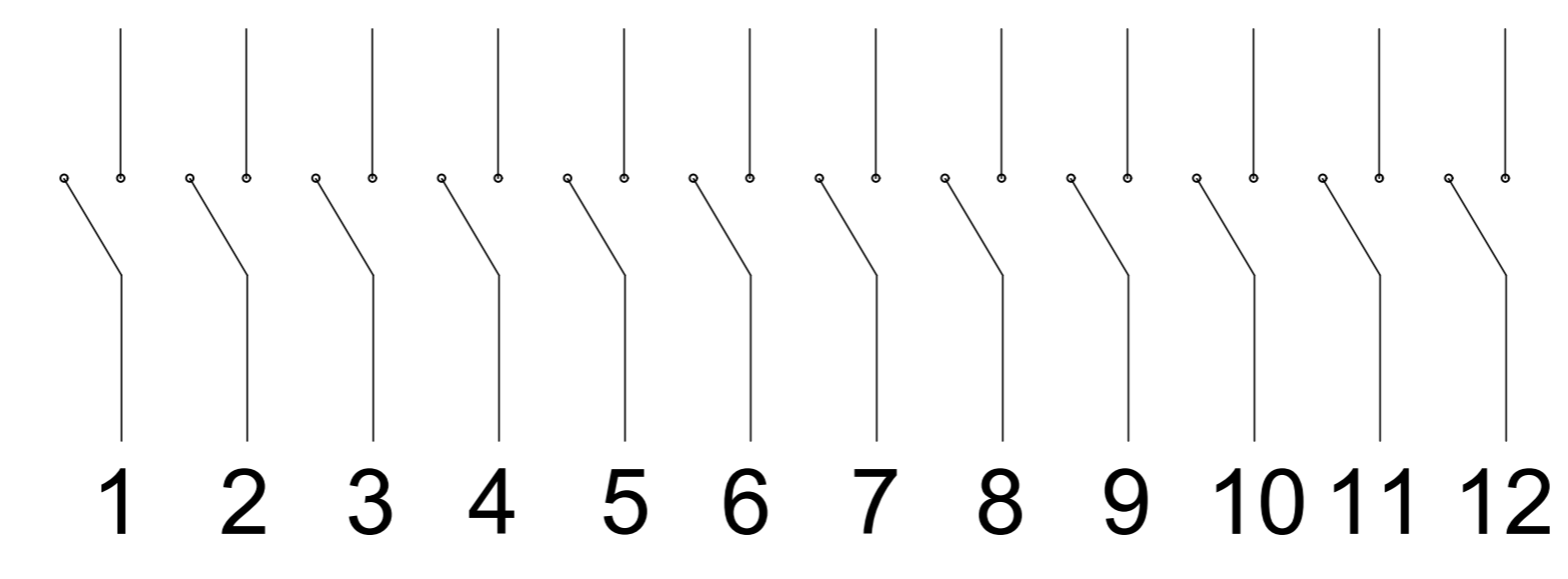
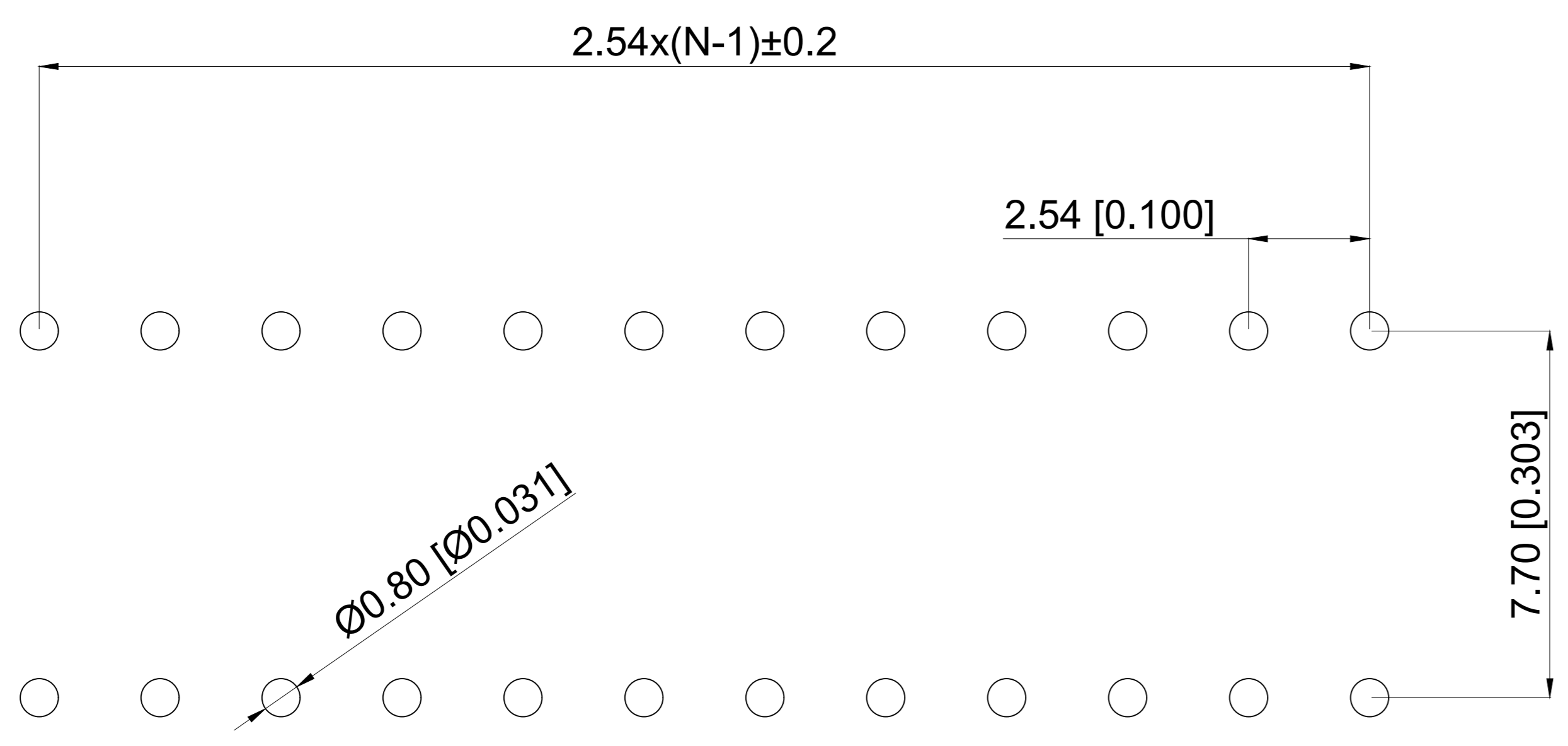

SCHMATIC

Part Name	Material	Finished
Base	PPS UL94 VO	Black
Cover	PPS UL94 VO	Black
Actuator	Nylon UL94 VO	White
Movadle	Copper Alloy	Gold
Terminal Contact	Brass	Gold
Terminal	Brass	Gold/Tin

A4

A3

A2

A1

REV	DATE	REVISION	DESCRIPTION	ISSUE
A4			Terminal	
A3				
A2				
A1				

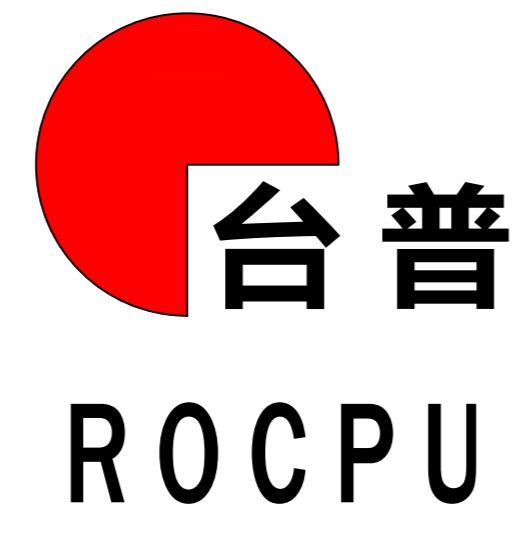

COMMON	TOLERANCE
X.XX	± 0.10
X.X	± 0.15
X	± 0.25
ANGULAR	—

UNIT	MM	PROJECTED	PRODUCT NAME:
DRAWN BY	FUYUAN	CHECKED BY	COCO
DATE	2019	APPROVAL B	ALEN
		MODEL NO: TAM101EZ	
		Https: www.rocpcu.tw	
<b>ROCPCU TECHNOLOGY CO.,LTD</b>			
Copies are issued in strict confidence and shall not be reproduced or copied, or used as the basis of manufacture or sale of apparatus without permission			

5

5

A

B

C

D

E

F

G