

修订 REV	标记 MARK	修改摘要 REVISION DESCRIPTION	签名 SIGNATURE	日期 DATE
AO		NEW RELEASE	黄艳兰	2022-07-10

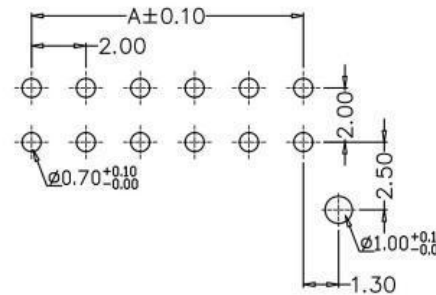
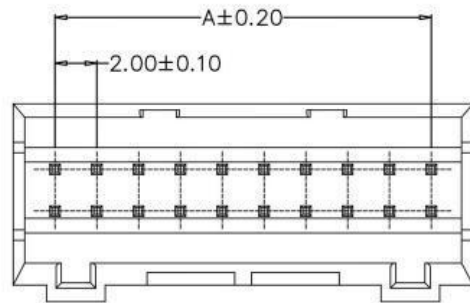
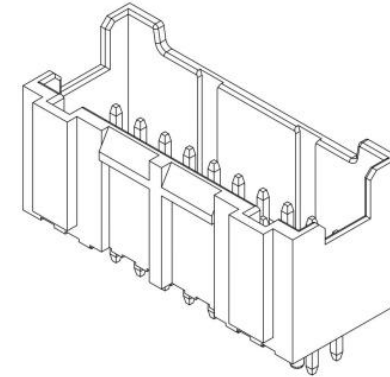
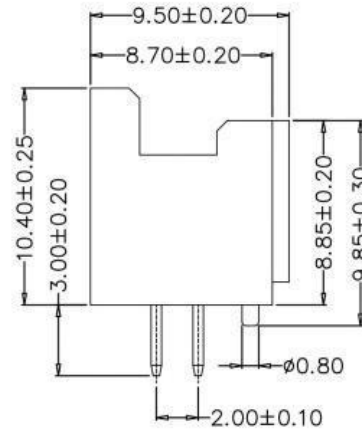
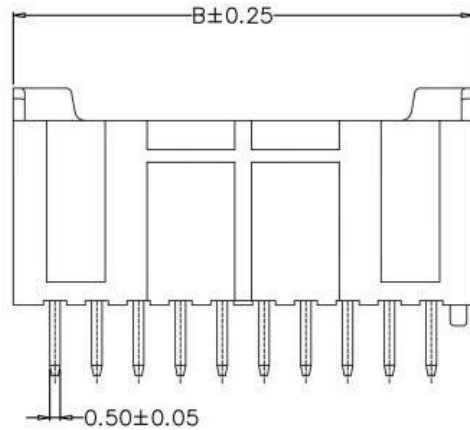

PCB LAYOUT

PIN	尺寸 (mm)	
	A	B
2x2P	2.00	6.00
2x3P	4.00	8.00
2x4P	6.00	10.00
2x5P	8.00	12.00
2x6P	10.00	14.00
2x7P	12.00	16.00
2x8P	14.00	18.00
2x9P	16.00	20.00
2x10P	18.00	22.00
2x11P	20.00	24.00
2x12P	22.00	26.00
2x20P	38.00	42.00

SPECIFICATIONS

- 1、Current Rating: 3A AC, DC
- 2、Voltage Rating: 250V AC, DC
- 3、Temperatuer Range: -25°C~+85°C
- 4、Contact Resistance: 20mΩ Max
- 5、Insulation Resistance: 1000MΩ Min
- 6、Withstanding Voltang: 800V AC/minute
- 7、Material: Wafer Nylon46, UL94V-0
PIN Brass Tin-plated



深圳市华德共创科技有限公司

Shenzhen Huade co-create Technology Co.,LTD
TEL : 0755-27111225 FAX : 0755-29940187

-TOLERANCES- UNLESS OTHERWISE SPECIFIED 公差参数表						TITLE: 产品名称: SPH2.0双排直针			
X.X	±0.30	X.X°	±3°	APPD: 核准:	谢亮	PART NO: 产品编号: HDGC2012WV-2xXP			
X.XX	±0.30	X.XX°	±2°	CHECK: 校对:	王建业	DATE	SCALE	UNIT	CODE NUMBER
X.XXX	±0.10	X.XXX°	±1°	DRAW: 绘图:	黄艳兰	2022-07-10	1:1	mm	A126