

NPN Silicon Power Transistor

The transistor is subdivided into four groups, R, Q, P and E, according to its DC current gain.

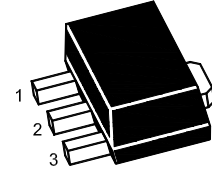

1.Base 2.Collector 3.Emitter
SOT-89 Plastic Package

Absolute Maximum Ratings ($T_a = 25\text{ }^\circ\text{C}$)

Parameter	Symbol	Value	Unit
Collector to Base Voltage	V_{CBO}	40	V
Collector to Emitter Voltage	V_{CEO}	30	V
Emitter to Base Voltage	V_{EBO}	5	V
Collector Current	I_C	3	A
Peak Collector Current (t = 10 ms)	I_{CP}	7	A
Total power dissipation ($T_a = 25\text{ }^\circ\text{C}$)	P_{tot}	1	W
Total power dissipation ($T_c = 25\text{ }^\circ\text{C}$)	P_{tot}	10	W
Junction Temperature	T_j	150	$^\circ\text{C}$
Storage Temperature Range	T_{stg}	- 55 to + 150	$^\circ\text{C}$

Characteristics at $T_a = 25\text{ }^\circ\text{C}$

Parameter	Symbol	Min.	Typ.	Max.	Unit
DC Current Gain at $V_{CE} = 2\text{ V}$, $I_C = 20\text{ mA}$ at $V_{CE} = 2\text{ V}$, $I_C = 1\text{ A}$ Current Gain Group	R	h_{FE}	30	-	-
	Q	h_{FE}	60	-	120
	P	h_{FE}	100	-	200
	E	h_{FE}	160	-	320
	E	h_{FE}	200	-	400
Collector Base Cutoff Current at $V_{CB} = 30\text{ V}$	I_{CBO}	-	-	1	μA
Emitter Base Cutoff Current at $V_{EB} = 3\text{ V}$	I_{EBO}	-	-	1	μA
Collector Emitter Saturation Voltage at $I_C = 2\text{ A}$, $I_B = 0.2\text{ A}$	$V_{CE(sat)}$	-	-	0.5	V
Base Emitter Saturation Voltage at $I_C = 2\text{ A}$, $I_B = 0.2\text{ A}$	$V_{BE(sat)}$	-	-	2	V
Gain Bandwidth Product at $V_{CE} = 5\text{ V}$, $I_C = 0.1\text{ A}$	f_T	-	90	-	MHz
Output Capacitance at $V_{CB} = 10\text{ V}$, $f = 1\text{ MHz}$	C_{ob}	-	45	-	pF

TYPICAL CHARACTERISTICS (Ta=25°C)

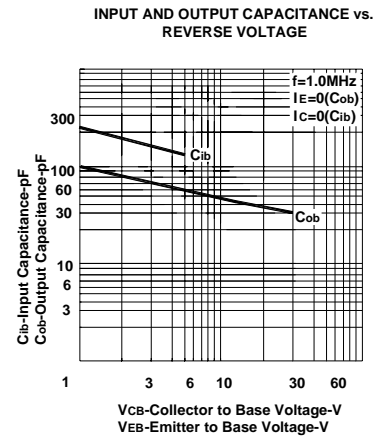
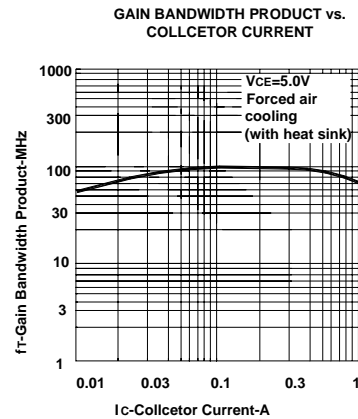
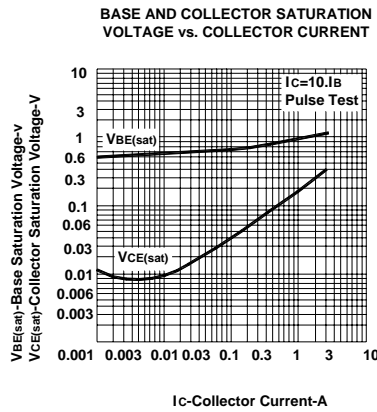
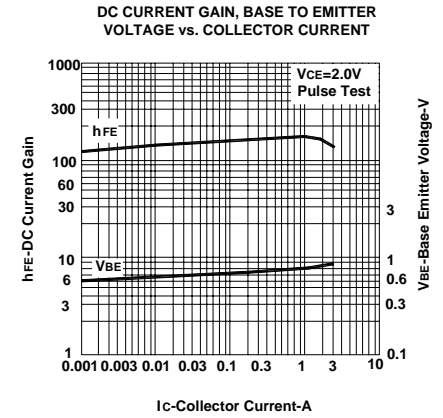
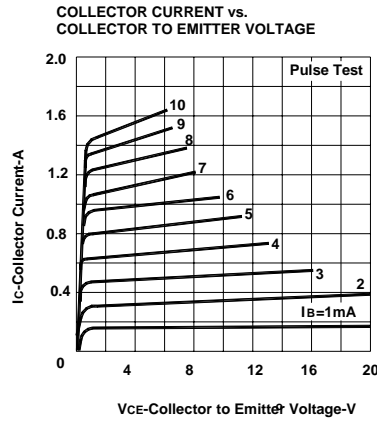
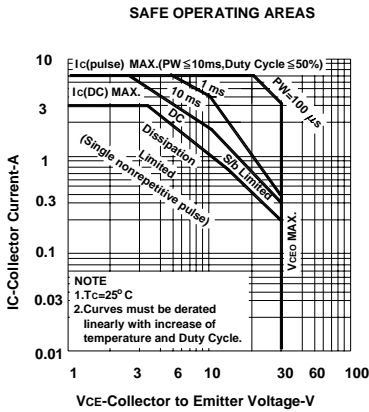
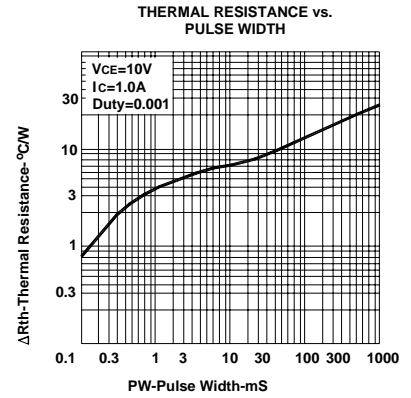
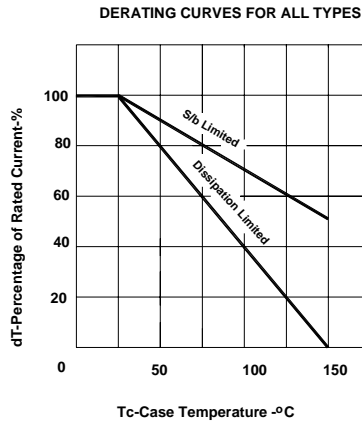
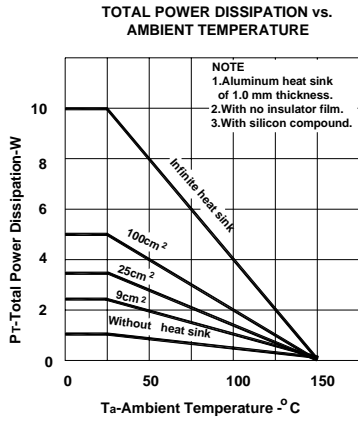

SOT-89 PACKAGE OUTLINE

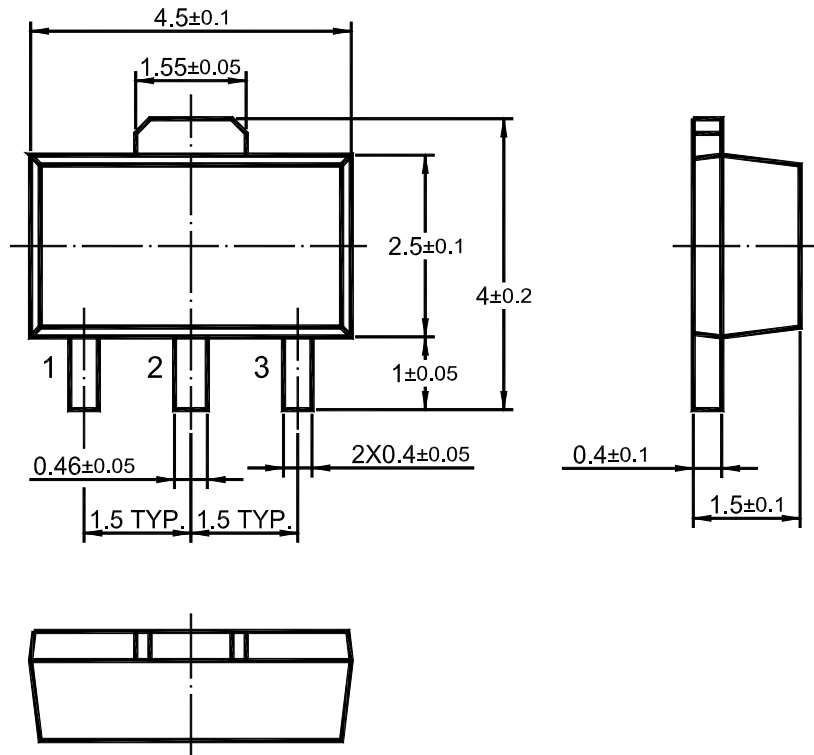

Dimensions in mm