

RoHS

CAD GENERATED DRAWING. DON'T CHANGE BY HAND

REV.	ECN. NO.	APPD.

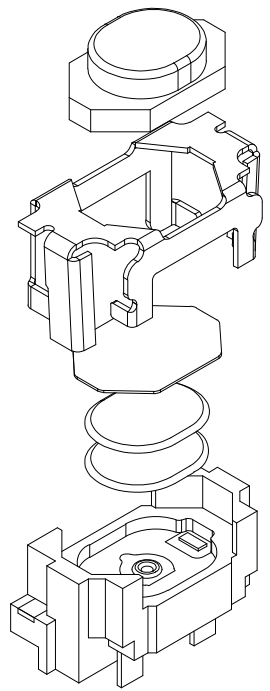

F
E
D
C
B
A

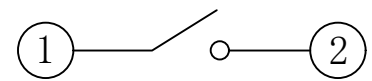
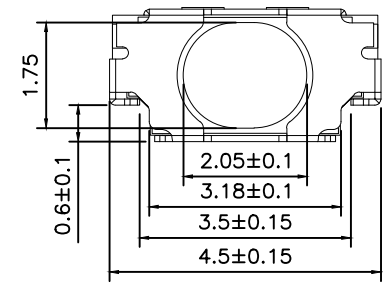
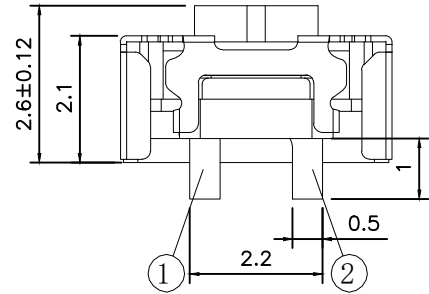
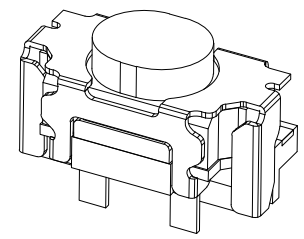
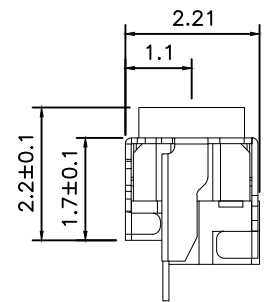

CIRCUIT DIAGRAM

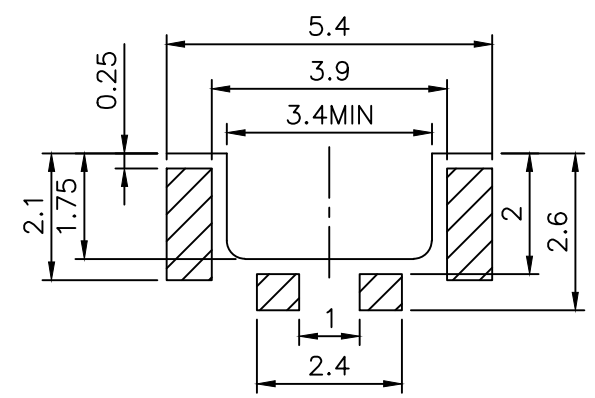

PCB. WELDING DRAWING

Specification

Operating Life	≥300,000
Contact rating	50mA@12V DC.
Insulation resistance	≥100Ω min.
Contact resistance	100mΩ max. initial.
Dielectric Strength	250 V AC(1mm)
Travel	0.15±0.1mm

F	button	LCP	1	Black
E	Cover	Stainless steel	1	Gold plated
D	Dust-proof membrane	polyimide	1	orange
C	shrapnel	Stainless steel	2	Plated Ag
B	noumenon	LCP	1	Black
A	Card	Phosphor copper	1	Plated Ag
ITEM	DESCRIPTION	MATERIAL	QTY	FINISH/COL DR

Mechanical

PN	Operating Force(gf)	Height mm
YTS1T0352AJ00	260±50	2.6
YTS1T0351AJ00	160±50	2.6

X. ±0.50	X.° ±2°	UNITS mm
.X ±0.30	.X° ±1°	
.XX ±0.10	.XX° ±0.5°	MAT'L
.XXX ±0.05		
THESE DRAWINGS AND SPECIFICATIONS ARE THE PROPERTY OF YIYUAN TECHNOLOGY CO.,LTD AND SHALL NOT BE REPRODUCED, COPIED OR USED IN ANY MANNER WITHOUT THE PRIOR WRITTEN CONSENT OF YIYUAN TECHNOLOGY CO.,LTD Email at info@yiyuanswitches.com		FINISH
		Q'TY

yi YUAN 深圳市怡远科技有限公司
SHENZHEN YIYUAN TECHNOLOGY CO.,LTD

PART NO. YTS1T035 TITLE: TACTILE SWITCH 2.2x4.5mm

APPD: ROGER DWG NO.: YTS1T035

CHKD: RDC

DR: BILLY WANG 2020/08/21

SCALE SHEET REV. 1/1 1/1 A1

Packaging:
Reel of 3,000 pieces.