

REV	MARK	修改摘要 REVISION DESCRIPTION	签名 SIGNATURE	日期 DATE
AO		NEW DWG		2016-03-12

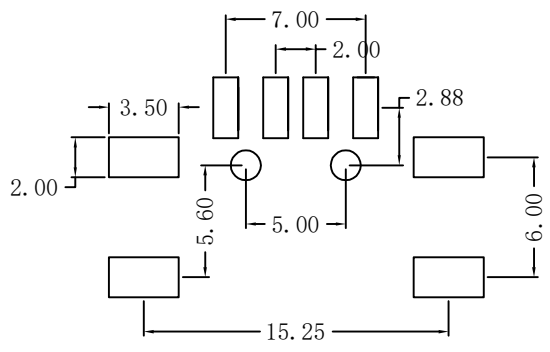

RECOMMENDED P.C.B LAYOUT

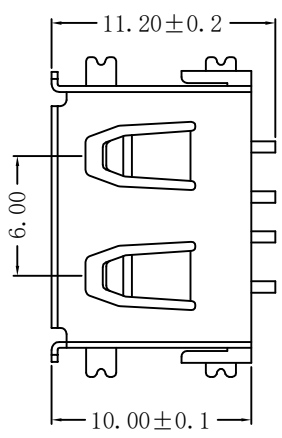
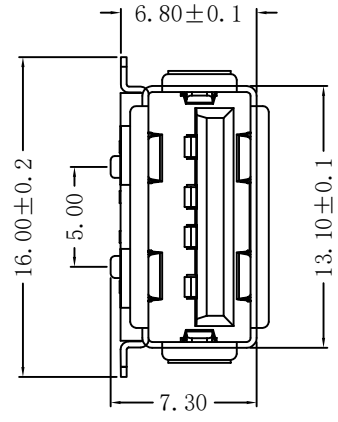
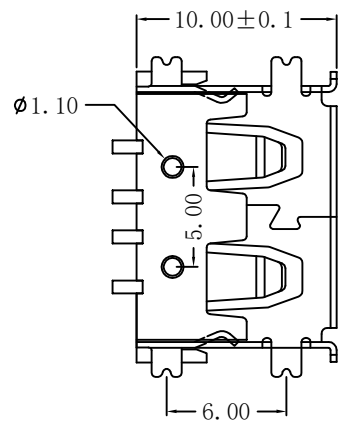
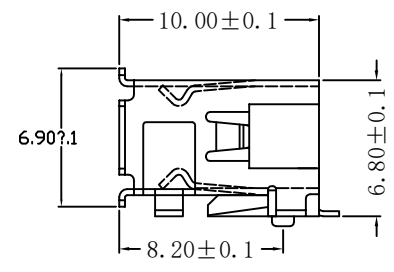

规格说明:Specifications:

电气特性:Electrical:

1. 额定电流: Current Rating
1.5A/contact terminal
2. 额定电压: Voltage Rating
30V DC
3. 接触阻抗: Contact Resistance
30 milliohms MAX
4. 耐电压: Dielectric Withstanding Voltage:
500 V AC AT Sea Level
5. 绝缘阻抗: Insulation Resistance:
1000MEGA ohms MIN

物理性能: Mechanical:

1. 插拔力: Connector Mate and Unmate Force
Mate force: 3.57kgf (MAX)
Unmate force: 1.02kgf (MIN)
2. 端子保持力: Terminal Retention
1.2kgf (MIN)



原材料: Material:

1. 塑胶: Housing:
Hing Temperature Thermoplastics,
LCP
2. 端子: Contact: Copper Alloy C2680
3. 外壳: Shell: Copper Alloy C2680/SPCC

电镀: Finish:

1. 端子: Contact: Plated Gold in Mating Area;
Tin On Solder Talls
2. 外壳: Shell:
Nickel Plating

由 Autodesk 教育版产品制作

		深圳市华德共创科技有限公司 Shenzhen Huade co-create Technology Co., LTD 电话: 0755-23304126 传真: 0755-29940187			
-TOLERANCES- UNLESS OTHERWISE SPECIFIED 公差参数表		 		TITLE: 产品名称: USB AF10.0四脚全贴6.8带柱卷边 黑胶LCP0.25	
X.X ±0.30	X.X* ±3°	APPD: 核准:	PART NO: 产品编号: USB-ZD-143SMT		
X.XX ±0.20	X.XX* ±2°	CHECK: 校对: 王建业	DATE	SCALE	UNIT
X.XXX ±0.10	X.XXX* ±1°	DRAW: 绘图: 黄艳兰	2016-03-12	1:1	mm
					CODE NUMBER A001

由 Autodesk 教育版产品制作