

REV REV NO	MARK	修改摘要 REVISION DESCRIPTION	签名 SIGNATURE	日期 DATE
		NEW DRG		2016-03-12

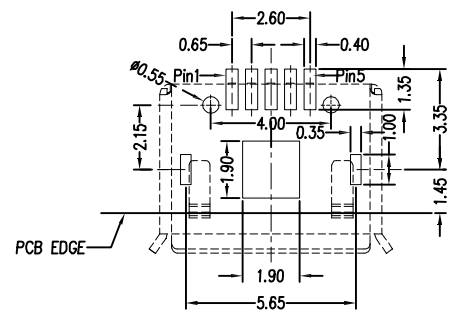
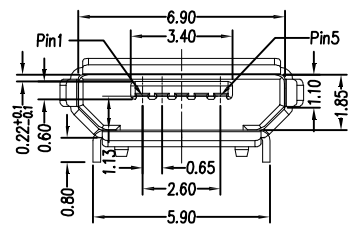
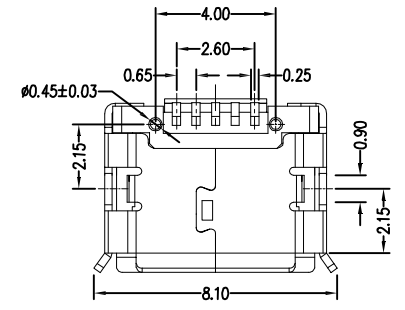
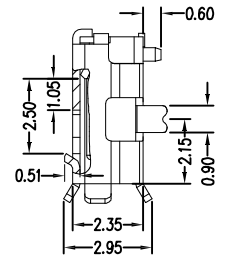
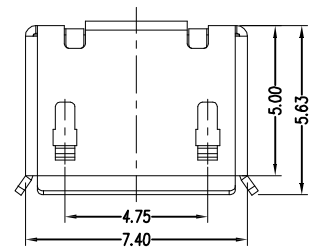
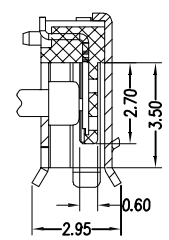
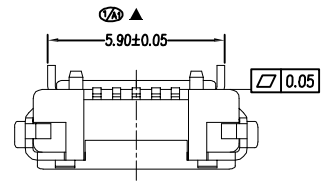

RECOMMENDED PCB LAYOUT  
PCB图仅供参考

备注Note:

原材料Material:

1. 塑胶Housing: High temperature thermoplastic with g.f, UL94v-0
2. 端子Contact: copper alloy, t=0.15mm
3. 外壳Shell: copper alloy, t=0.25mm

规格说明Specification:

1. 额定电流Current rating: 1, 5PIN 1.8A Max/2, 3, 4PIN 1A Max.
2. 耐压Dielectric withstanding voltage: 100 V(ac) for 1 min.
3. 接触阻抗Contact resistance: 30 mΩ Max.
4. 绝缘阻抗Insulation resistance: 100 MΩ Min.
5. 插入力Total mating force: 3.57 Kgf Max.
6. 拔出力Total unmating force: 1.0 Kgf Min.
7. 工作温度Temperature range: -30° C~80° C

端子电镀 01: Au1u"; 02: Au1.5u"; 03: Au3u"  
05: Au5u"; 10: Au10u"; 15: Au15u"; 30: Au30u"



主体颜色: 黑色

主体材质: LCP

端子材质: C5191R-EH

外壳电镀 1: N50u" 2: 雾T50u" 3: N+Au1u" (脚) 4: Au1u"

外壳材质: C2680R-H SUS304R-1/2H

 深圳市华德共创科技有限公司 Shenzhen Huade co-create Technology Co., LTD 电话: 0755-23304126 传真: 0755-29940187								
-TOLERANCES- UNLESS OTHERWISE SPECIFIED 公差参数表		 		TITLE: MICRO5.9卷边铜壳滚镀有柱针长 产品名称: 1.0				
X.X	±0.30	X.X*	±3°	APPD: 核准:	PART NO: 产品编号: MICRO-ZL-116PWB			
X.XX	±0.20	X.XX*	±2°	CHECK: 校对: 王建业	DATE	SCALE	UNIT	CODE NUMBER
X.XXX	±0.10	X.XXX*	±1°	DRAW: 绘图: 黄艳兰	2016-03-12	1:1	mm	A001

由 Autodesk 教育版产品制作

由 Autodesk 教育版产品制作