

Reverse Voltage - 100 Volts

Forward Current - 40Amperes

FEATURES

- Power pack
- Metal silicon junction ,majority carrier conduction
- Guard ring for overvoltage protection
- Low power loss ,high efficiency
- High current capability ,low forward voltage drop
- High forward surge capability
- High frequency operation

MECHANICAL DATA

- Case: JEDEC ITO-220AB
- Molding compound meets UL94V-0 flammability rating
- Terminals: Lead solderable per J-STD-002 and JESD22-B102
- Polarity: As marked
- Mounting Torque: 10 in-lbs maximum

TYPICAL APPLICATIONS

For use in low voltage ,high frequency inverters ,DC/DC converters, free wheeling ,and polarity protection applications

MAXIMUM RATINGS

(Ratings at 25°C ambient temperature unless otherwise specified)

Parameter	Symbol	MBR40100LCT	
Maximum repetitive peak reverse voltage	V_{RRM}	100	V
Maximum average forward rectified current (see fig.1)	Per leg	20.0	A
	Total device	40.0	
Peak forward surge current 8.3ms single half sine-wave superimposed on rated load (JEDEC method at rated TL)	I_{FSM}	300	A
Peak repetitive reverse current per diode at $t_p=2 \mu s$ 1KHz	I_{RRM}	0.5	A
Operating junction and Storage temperature range	T_J, T_{stg}	-55 to+150	°C
Isolation voltage (ITO-220AB only) from terminals to heatsink $t=1$ min	V_{AC}	1500	V

ITO-220AB

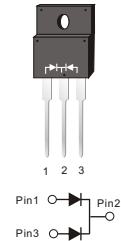

PRIMARY CHARACTERISTICS

$I_f(AV)$	2×20A
V_{RRM}	100V
I_{FSM}	300A
V_f at $I_f=20.0A$,Per leg	0.71V
I_r	30 μ A
$T_J(MAX)$	150°C
Package	ITO-20AB
Diode variations	Common cathode

ELECTRICAL CHARACTERISTICS (T_A=25°C Unless otherwise noted)

Parameter	Test Conditions		Symbol	TYP.	MAX.	Unit
Instaneous forward voltage	Per leg I _F =20.0A	T _A =25°C	V _F	0.71	–	V
Reverse current	V _R =100V	T _A =25°C	I _R	30	60	μA
		T _A =100°C		3	5	mA
		T _A =125°C		12	20	
Typical junction capacitance	4V, 1MHz		C _J	570		pF
Typical thermal resistance			R _{θJC}	2.5		°C/W

FIG.1-FORWARD CURRENT DERATING CURVE

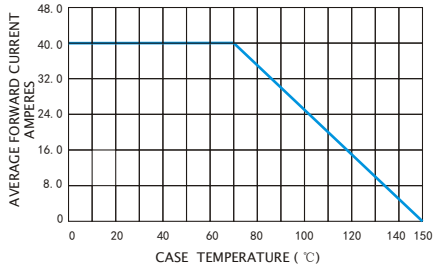

FIG.2-MAXIMUM NON-REPETITIVE PEAK FORWARD SURGE CURRENT

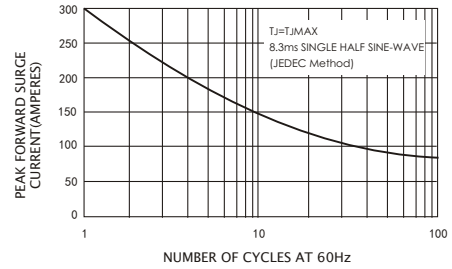

FIG.3-TYPICAL INSTANTANEOUS FORWARD CHARACTERISTICS

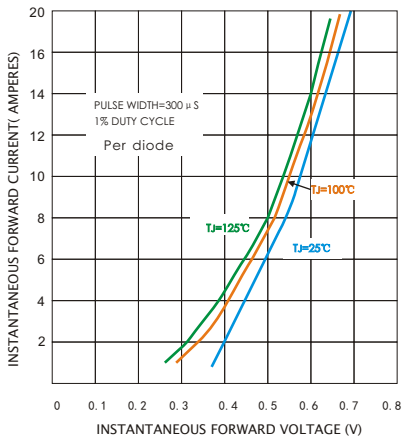

FIG.4-TYPICAL REVERSE CHARACTERISTICS

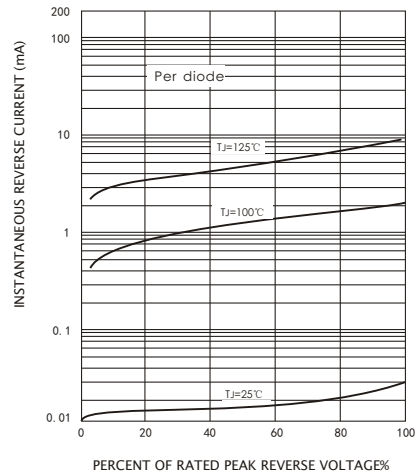
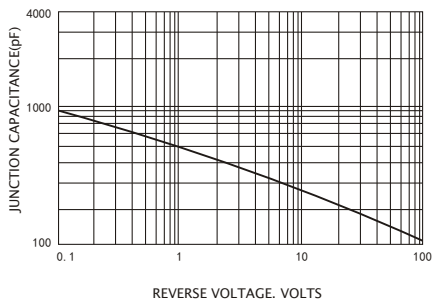
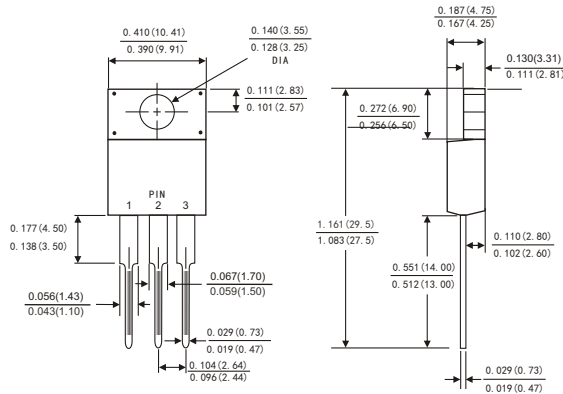

FIG.5-TYPICAL JUNCTION CAPACITANCE



PACKAGE OUTLINE DIMENSIONS

ITO-220AB



Dimensions in inches and (millimeters)