




SPECIFICATION FOR APPROVAL

File No.: O/FRK 0.GS.E.C45-C13

Product Name	Metallized Polypropylene Film Interference Suppression Capacitor (Class X1: 440Vac/480Vac)
Product Type	MKP65
Product Code	C45
Customer	
Customer Code	
Issue Date	2020-05

Xiamen Faratronic Co. Ltd.			Approved by Customer
Drafted	Checked	Approved	
			



Xiamen Faratronic Co. Ltd.

Add: 99 Xinyuan Road, Haicang District, Xiamen, China

Marketing/Sales center

TEL: 0086-592-6208620 6208505 6208586

FAX: 0086-592-6208777

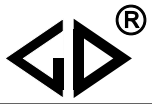
Mail: Vitawang@faratronic.com.cn

Donny@faratronic.com.cn

James@faratronic.com.cn

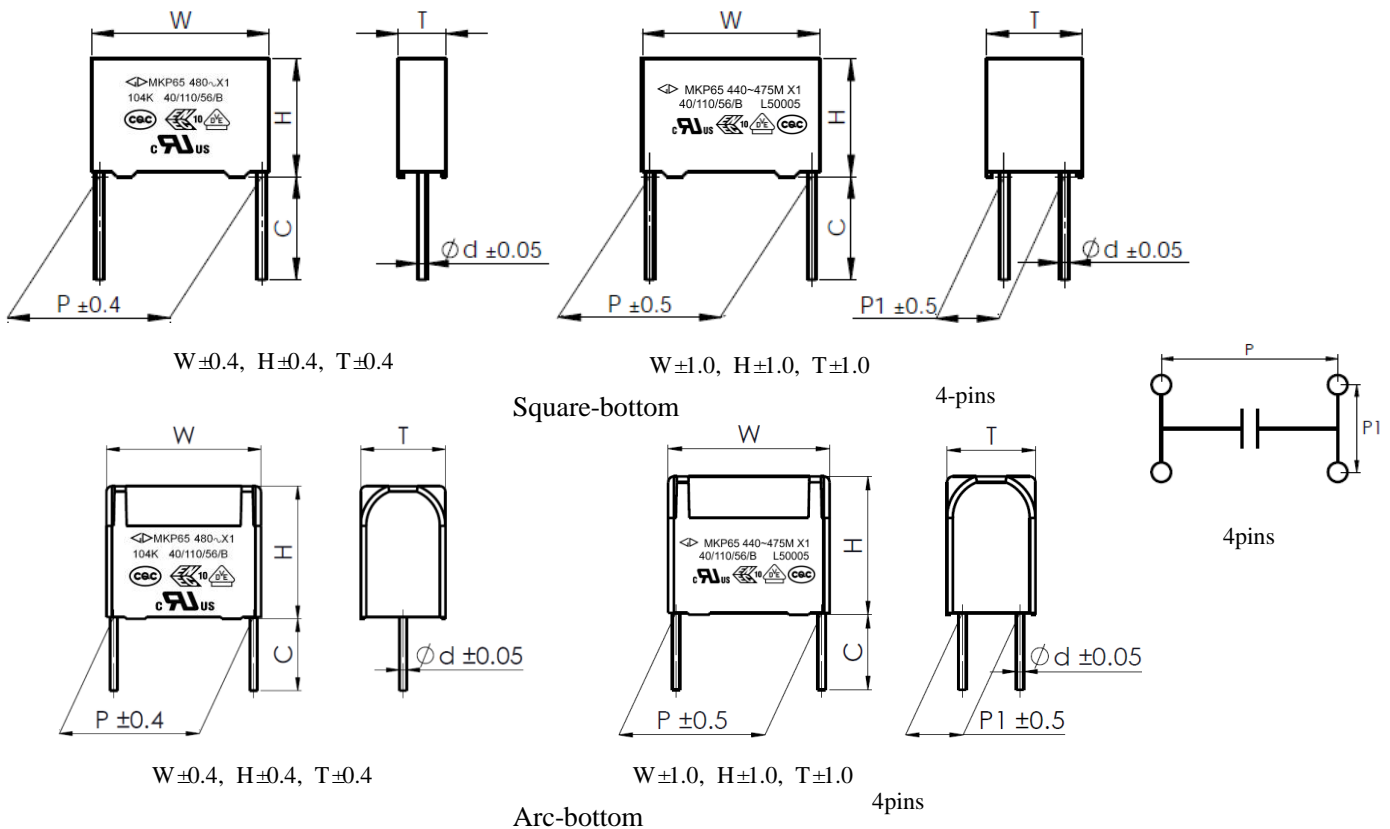
Http: www.faratronic.com.cn

*.The specification are the property of Xiamen Faratronic Co.Ltd and shall not be copied or used as commercial purposes without permission.



Version history

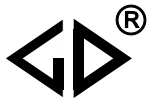
Current version	Date	Author	Change description

Metallized polypropylene film interference suppression capacitor (Class X1, 440Vac/480Vac)
■ Outline Drawing

■ Features

- Metallized polypropylene structure
- Compact size
- Withstanding overvoltage stressing
- Excellent active and passive flame resistant abilities
- Used in across-the-line, interference suppression circuit.

■ Safety Approvals

•	CQC	IEC 60384-14:2013, X1, 440Vac/480Vac, 0.0010 μ F~10.0 μ F, 40/110/56/B Certificate No.: CQC06001016942
•	ENEC-VDE	EN 60384-14:2013+A1:2016, X1, 440Vac/480Vac, 0.0010 μ F~10.0 μ F, 40/110/56/B Certificate No.: 40021925
•	UL/CUL	UL60384-14:2014, CSA E60384-14:09, X1, 440Vac/480Vac, 0.0010 μ F~10.0 μ F, 40/110/56/B File No.: E186600, CCN: FOWX2/8



■ Specifications

Class	Class X1		
Climatic Category / Passive Flammability Category	40/110/56/B		
Operating Temperature Range	-40°C ~ +110°C		
Rated Voltage (U _R)	440Vac/480Vac, 50/60Hz		
Maximum continuous DC voltage	1 000Vdc		
Capacitance Range	0.0010μF~10.0μF		
Capacitance Tolerance	±10%(K), ±20%(M)		
Voltage Proof	Between Terminals:	4.3U _R (dc), 2s	
	Between Terminals To Case:	2560 (Vac), 1min	
Insulation Resistance	R≥15 000MΩ , C _N ≤0.33μF	(20°C, 100V ,1min)	
	R _{CN} ≥5 000s, C _N >0.33μF		
Dissipation Factor(tanδ)	0.0010μF<C _N ≤0.010μF	≤25×10 ⁻⁴ (1kHz,20°C)	≤25×10 ⁻⁴ (10kHz,20°C)
	0.010μF<C _N ≤0.47μF	≤15×10 ⁻⁴ (1kHz,20°C)	≤20×10 ⁻⁴ (10kHz,20°C)
	0.47μF<C _N ≤1.0μF	≤20×10 ⁻⁴ (1kHz,20°C)	≤40×10 ⁻⁴ (10kHz,20°C)
	1.0μF<C _N	≤30×10 ⁻⁴ (1kHz,20°C)	-----
<p>Note: 1. If used in application which has ripple current applied, recommend to use AC filter series: C6A etc. If have any questions please contact our technical engineer for more detail; 2. For outdoor or severe humidity condition application, recommend to use THB series.</p>			



■ Part number system

The 15 digits part number is formed as follow:

1	2	3	4	5	6	7	8	9	10	11	12	13	14	15
C	4	5												

Digit 1 to 3 Series code

C45=MKP65

Digit 4 to 5 A.C. rated voltage

S1=440V S3=480V

Digit 6 to 8 Rated capacitance value

For example : 103=10×10³ pF= 0.01μF

Digit 9 Capacitance tolerance

K=±10%, M=±20%

Digit 10 Pitch

3=7.5 mm 4=10.0mm 6=15.0mm 9=22.5mm

B=27.5mm F=37.5mm M=52.5mm

Digit 11 Internal use

Digit 12 to 15 Lead form and packaging code

Table1 Lead form and packaging code

Digit 12		Digit 13		Digit 14		Digit 15	
code	explanation	code	explanation	code	explanation	code	explanation
A	ammo-pack	4 6	F=10.0mm F=15.0mm	0	straight	5	P3=25.4mm;H=18.5mm (For pitch=10/15mm)
C	straight lead "C" in the figure above	code	explanation		0	Length tolerance ±0.5mm Or standard length	
		00 45	standard lead length (18mm~26mm) lead length 4.5mm				
T 3	P1=20.3mm±0.5mm P1=20mm±0.5mm	45 55	lead length 4.5mm lead length 5.5mm		0	Length tolerance ±0.5mm or standard length	

Note: Recommend short lead due to long lead could deform easily.

Maximum permissible voltage change per unit of time

Rated Voltage (Vac)	dV/dt(V/us) at 680 Vdc				
	P=10mm	P=15mm	P=22.5mm	P=27.5mm	P=37.5mm
440	750	600	300	225	150

Note: 1. Rated voltage pulse slope (dV/dt)_R at rated voltage.

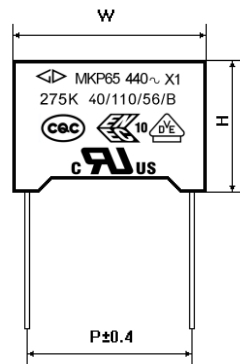
2. If the working voltage(U) is lower than the rated voltage(U_R),the capacitor can be worked at a higher dV/dt. In this case, the maximum allowed dV/dt is obtain by multiplying the right value with U_R/U.

Test Method And Performance

No.	Item	Performance	Test Method (IEC 60384-14)
1	4.5 Solderability	Good quality of tinning	Solder temperature: 245°C ±5°C Immersion time: 2.0s±0.5s
2	4.3 Terminal strength (straight lead)	There shall be no visible damage	Tense: 0.50<d≤0.80, 10N 0.80<d≤1.25, 20N Bend: 0.50<d≤0.80, 5N 0.80<d≤1.25, 10N The terminals shall be bent 2 times in each direction
3	4.4 Resistance to solder heat	There shall be no visible damage ΔC/C ≤±5%(relative to the initial value)	Solder temperature:260°C±5°C Immersion time: 10s±1s
4	4.20 Solvent resistance of the marking	The marking shall be legible	Solvent: Industrial isopropanol. Solvent temperature:23°C±5°C Dipping time: 5min±0.5min Condition: scrub Scrub material: absorbent cotton Reverting time: No
5	4.2 Initial measurement	Capacitance, Tgδ	
	4.6 Rapid change of temperature	There shall be no evidence of deterioration.	θ _A =-40°C, θ _B =+110°C 5 cycles Duration: t=30min
	4.7 Vibration(straight lead)	There shall be no evidence of deterioration.	Amplitude 0.75mm or acceleration 98m/s ² (whichever is the smaller severity), f: 10Hz to 500Hz. Three directions, 2h for each direction, total 6h.
	4.8 Bump(straight lead)	There shall be no evidence of deterioration.	4 000 times, Acceleration: 400m/s ² , Pulse duration, 6ms
	Final measurement	There shall be no visible damage ΔC/C ≤±5%(relative to the initial value)	
6	4.11 Climate sequence	Initial measurement	
		Dry heat	+110°C, 16h
		Damp heat, Cyclic	Test Db, Severity: b, the first cycle
		Cold	-40°C, 2h
		Damp heat, cyclic other	Test Db, Severity b, the other cycles
		Final measurement	There shall be no visible damage, legible marking ΔC/C ≤±5%(relative to the initial value) Increase of tgδ: C _N ≤1μF: ≤0.008 (10kHz) C _N >1μF: ≤0.005 (1kHz) Dielectric strength : there shall be no permanent breakdown or flashover I.R.: ≥ 50% of the rated value

No.	Item	Performance	Test Method (IEC 60384-14)
7	4.12 Damp heat steady state	There shall be no visible damage, legible marking $\Delta C/C \leq \pm 5\%$ (relative to the initial value) Increase of $\text{tg}\delta$: $C_N \leq 1\mu\text{F}$: ≤ 0.008 (10kHz) $C_N > 1\mu\text{F}$: ≤ 0.005 (1kHz) Dielectric strength : there shall be no permanent breakdown or flashover I.R.: $\geq 50\%$ of the rated value	Temperature: $40^\circ\text{C} \pm 2^\circ\text{C}$ Humidity: $93 \pm 2\% \text{RH}$ Duration: 56 days
8	4.13 Impulse voltage	There are three or more waveforms which indicate that no self-heating breakdown have occurred when it is monitored by the monitor	Each individual capacitor shall be subjected to 24 impulses of the same polarity (when any three successive impulses are shown by the monitor to have a wave form indicating that no self-healing breakdown have taken place the impulses can be stopped), the time between impulses shall not be less than 10s, and the peak value of the voltage impulse: 4.0kV (suitable for $C_N \leq 1\mu\text{F}$; When $C_N > 1\mu\text{F}$, the capacitor can endure pulse voltage value is $4.0/\sqrt{C_N}$ kV)
9	4.14 Endurance	There shall be no visible damage, legible marking $\Delta C/C \leq \pm 10\%$ (relative to the initial value) Increase of $\text{tg}\delta$: $C_N \leq 1\mu\text{F}$: ≤ 0.008 (10kHz) $C_N > 1\mu\text{F}$: ≤ 0.005 (1kHz) Dielectric strength : There shall be no breakdown or flashover I.R. : $\geq 50\%$ of the rated value	+110°C, 1.25U _R Va.c., 1 000h The voltage shall be subjected to 1000Vrms for 0.1s every one hour during test.
10	4.15 Charging and discharging	$\Delta C/C \leq \pm 10\%$ (relative to the initial value) Increase of $\text{tg}\delta$: $C_N \leq 1\mu\text{F}$: ≤ 0.008 (10kHz) $C_N > 1\mu\text{F}$: ≤ 0.005 (1kHz) I.R.: $\geq 50\%$ of the rated value	Times: 10 000 Duration of charging: 0.5s Duration of discharging: 0.5s Charging voltage: $\sqrt{2} U_R \text{ Vd.c.}$ Charging resistance: $220/C_N (\Omega)$ or the current $\leq 1.0\text{A}$ (whichever is the minor) Discharging resistance: $R = \frac{\sqrt{2} U_R}{C_N \times \frac{dU}{dt}} (\Omega)$ C _N : Capacitance (μF)
11	4.17 Passive flammability	The flaming time of each capacitor shall not go beyond 10s after it is taken apart from the flame. Drop of each capacitor caused by flame shall not fire the tissue below.	Needle flame test The category of flammability: B Expose time: 1 time Capacitor Volume Exposing time $250 < V(\text{mm}^3) \leq 500$ 20s $500 < V(\text{mm}^3) \leq 1750$ 30s $V(\text{mm}^3) > 1750$ 60s

No.	Item	Performance	Test Method (IEC 60384-14)
12	4.18 Active flammability	The cheese cloth around the capacitor shall not burn with a flame.	The specimens shall be individually wrapped in at least 1, but not more than 2, complete layers of cheesecloth, the cheesecloth shall be untreated pure cotton cloth. Each sample shall be subjected to 20 discharged, the interval between successive discharges shall be 5s. $U_i = 4.0kV_0^{+7} \%$ U_R be applied and be maintained for 120_0^{+10} s after the last discharge.

■ Marking (For example)


Marking Introduction:

Sign	explain	Sign	explain
	Brand	40/110/56/B	Climate category / Passive Flammability Class
MKP65	Type		CQC Approval
440~	Rated voltage		ENEC-VDE Approval
X1	Class		UL&CUL Approval
275K	Rated capacitance and tolerance		

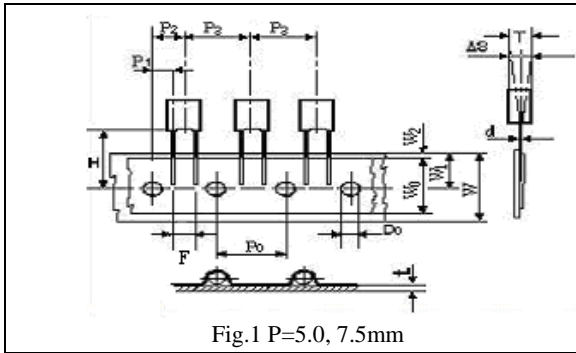
■ Taping specification for box-type capacitors
▲ Outline Drawing


Fig.1 P=5.0, 7.5mm

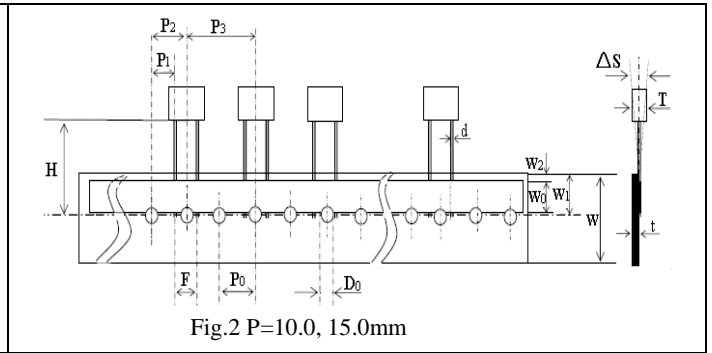


Fig.2 P=10.0, 15.0mm

▲ Taping Dimensions(mm)

Technology index title	Code	Dimensions				
		P=5.0	P=7.5	P=10.0	P=15.0	Tolerance
Taping type	—	Fig 1	Fig 1	Fig2	Fig 2	—
Part number Digit12-15	Ammo-pack	A201	A301	A405	A605	
Taping pitch	P ₃	12.7	12.7	25.4	25.4	±1.0
Feed hole pitch	P ₀	12.7	12.7	12.7	12.7	±0.3
Center of wire	P ₁	3.85	2.6	7.7	5.2	±0.7
Center of body	P ₂	6.35	6.35	12.7	12.7	±1.3
Pitch of taping wire	F**	5.0	7.5	10.0	15.0	+0.6 -0.1
Component alignment	ΔS	0	0	0	0	±2.0
Height of component from tape center	H***	18.5	18.5	18.5	18.5	±0.5
Carrier tape width	W	18.0	18.0	18.0	18.0	+1.0 -0.5
Hold down tape width	W ₀	6min	10min	10min	10min	—
Hole position	W ₁	9.0	9.0	9.0	9.0	±0.5
Hold down tape position	W ₂	3max	3max	3max	3max	—
Feed hole dia.	D ₀	4.0	4.0	4.0	4.0	±0.2
Tape thickness	t	0.7	0.7	0.7	0.7	±0.2

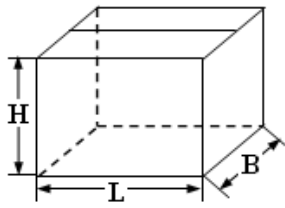
Note: * P₀=15mm is also available;

**F can be other lead spacing;

***H=16.5mm is available;

■ Packing box sizes(mm)(example)

1. Out packing box for bulk



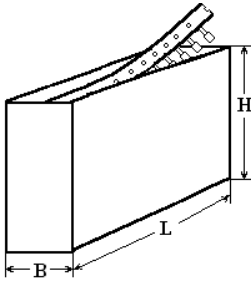
L:375±5
B:375±5
H:265±5

2. Inner packing box for bulk



L:355±3
B:175±3
H:118±3

3. Box sizes for Ammo-pack



L:350±3
B:50±3
H:260±3