

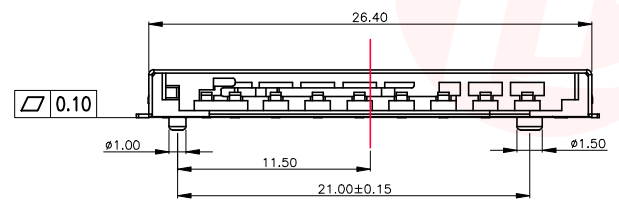

| | | | |
|------|-----------------------|---------|------|
| REV. | ECN NO OR DESCRIPTION | REVISED | DATE |
| | | | |
| | | | |

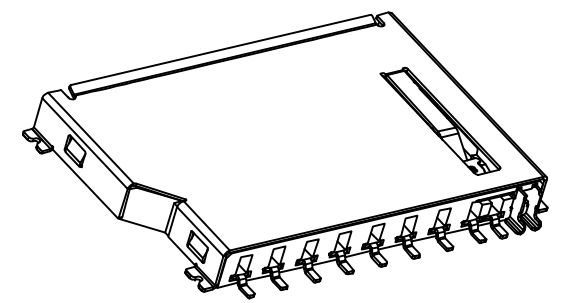
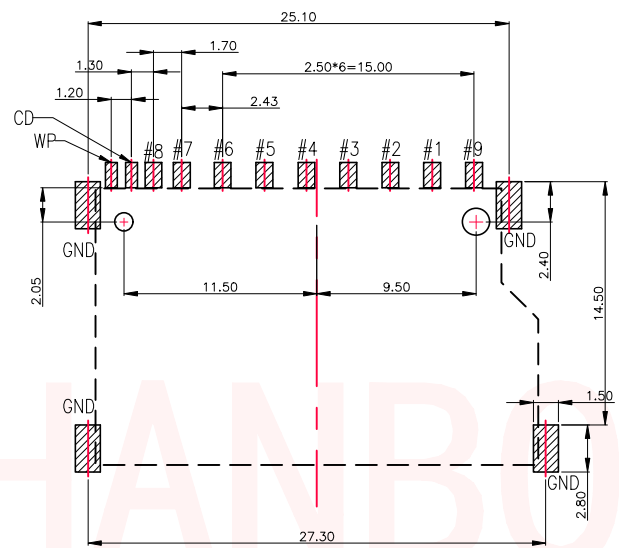
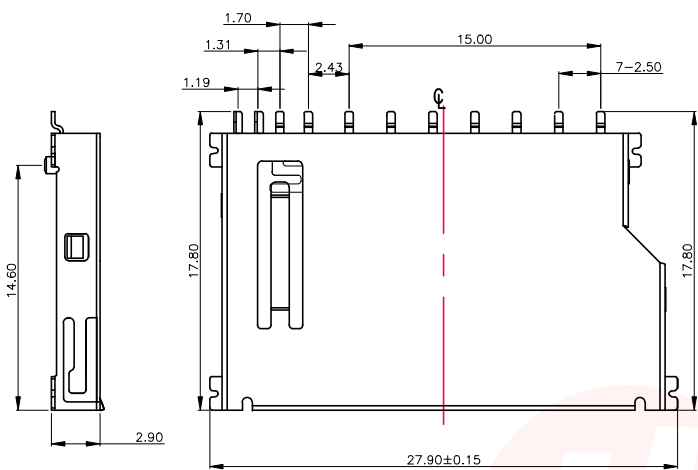

RECOMMENDED P.C.B LAYOUT (TOP VIEW)

SPECIFICATION

MATERIAL

Insulator: LCP UL94V-0
Terminal: C2680 H T:0.20mm
Shell: C2680 H T:0.20mm

ELECTRICAL

Operation Voltage: 12 V DC Max.
Current Rating: 0.5 Amps Max.
Contact Resistance: 100mΩ Max.
Insulation Resistance: 1000MΩ Min./500 VDC
Dielectric Withstanding Voltage: 500 VAC / Minute
Temperature Range: -25°C To +80°C

| PIN# | NAME |
|------|---------|
| 1 | CD/DAT3 |
| 2 | CMD |
| 3 | VSS1 |
| 4 | VDD |
| 5 | CLK |
| 6 | VSS2 |
| 7 | DAT0 |
| 8 | DAT1 |
| 9 | DAT2 |

CIRCUIT:

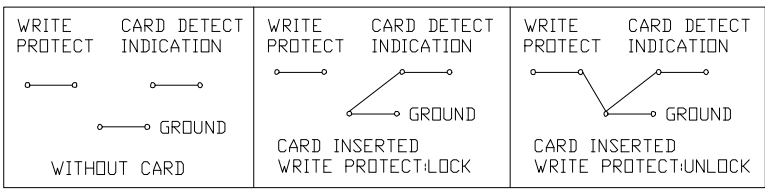

| | | | | |
|----|-------------|-----|-----------------------|---|
| C | SHIELD | 1 | STAINLESS STEEL 0.20t | Ni PLATING |
| B | CONTACT | 11 | COPPER ALLOY 0.20t | Gold Flash on Contact Area Matte-Tin plated on Solder tail All over Nickel Plated . |
| A | HOUSING | 1 | THERMOPLASTIC UL94-V0 | WHITE |
| NO | DESCRIPTION | QTY | MATERIAL | PLATING & COLOR |

| | | | | | |
|---------------------------------------|-----------------------------|---|-------------|---------|--|
| UNLESS OTHERWISE SPECIFIED TOLERANCES | | 东莞市汉博电子科技有限公司 DONGGUAN HANBO TECHNOLOGY CO., LTD | | | |
| TITLE | SD CARD CONN SHORT BODY SMT | | | | |
| DWN | xiong | SD-112S | | | |
| CHKD | lee | SCALE:1:1 | UNIT: mm | | |
| APVD | wang | SIZE: A4 | SHEET:10F 1 | REV: A4 | |
| CUSTOMER COPY | | | | | |



| REV. | ECN NO OR DESCRIPTION | REVISED | DATE |
|------|-----------------------|---------|------|
| | | | |
| | | | |

THE PACKING FOR SD CARD SERIES PUSH TYPE

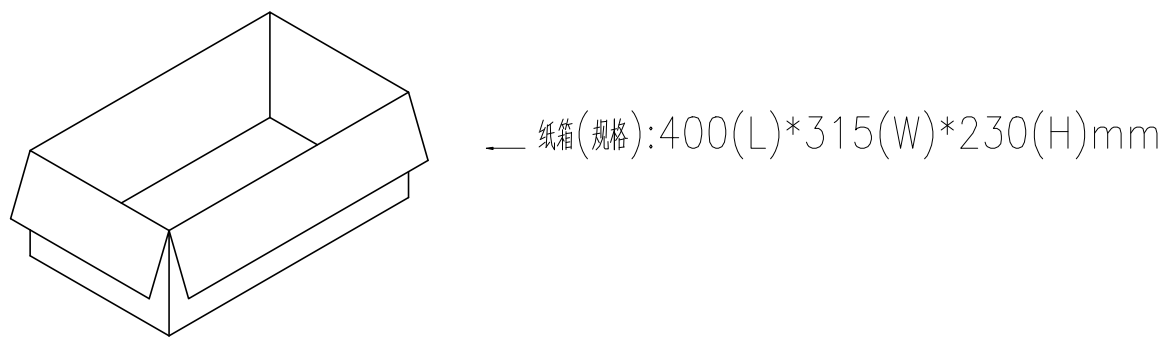
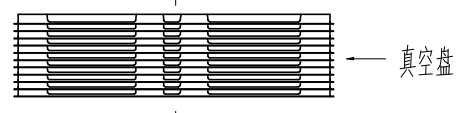
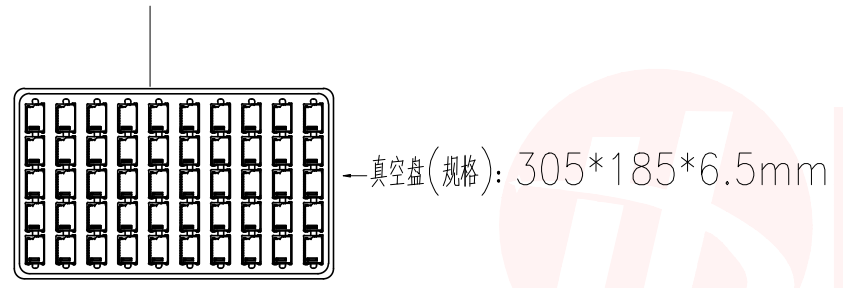
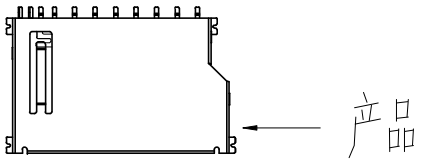

注意 (Note):

1. 将产品一一放入真空盒内，依同一方向摆放
2. 产品放置时，如图所示
3. 每个真空盘装入50pcs 产品
4. 一个纸箱可放入102个真空盘
5. 最上面一个真空盘用作上盖，不装入产品
6. 一个纸箱可装入5000 PCS产品
7. 若有未装满之尾数箱，必须用缓冲材加满
8. 装满产品之纸箱，最大堆积数量为5箱

| | | | | |
|---------------------------------------|-------------|---|-----------------------------|---|
| C | SHIELD | 1 | STAINLESS STEEL 0.20t | Ni PLATING |
| B | CONTACT | 11 | COPPER ALLOY 0.20t | Gold Flash On Contact Area Matte-Tin plated on Solder tail All over Nickel Plated . |
| A | HOUSING | 1 | THERMOPLASTIC UL94-V0 | WHITE |
| NO | DESCRIPTION | QTY | MATERIAL | PLATING & COLOR |
| UNLESS OTHERWISE SPECIFIED TOLERANCES | | 东莞市汉博电子科技有限公司 DONGGUAN HANBO TECHNOLOGY CO., LTD | | |
| DECIMALS: | ANGLES: | TITLE | SD CARD CONN SHORT BODY SMT | |
| X :±0.35 | X :±2° | DWN | xiong | SD-112S |
| X.X :±0.25 | X.X :±1° | CHKD | lee | SCALE:1:1 UNIT: mm |
| X.XX :±0.15 | | APVD | wang | SIZE: A4 SHEET:10F 1 REV: A4 |
| CUSTOMER COPY | | | | |