

**Product Summary**

$V_{(BR)DSS}$	$R_{DS(on)TYP}$	$I_D$
-20V	70mΩ@-4.5V	-2.3A
	110mΩ@-2.5V	

**Feature**

- TrenchFET Power MOSFET
- Excellent  $R_{DS(on)}$  and Low Gate Charge

**Application**

- DC/DC Converter
- Load Switch for Portable Devices
- Battery Switch

**MARKING:**

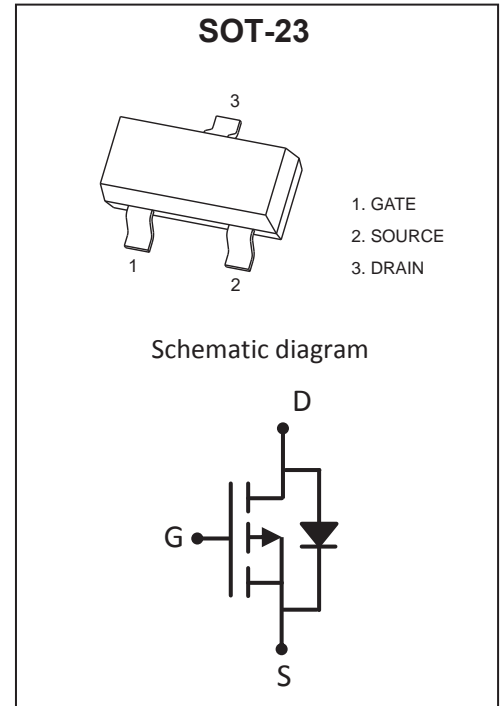
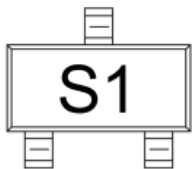

**ABSOLUTE MAXIMUM RATINGS ( $T_a=25^\circ\text{C}$  unless otherwise noted)**

Parameter	Symbol	Value	Unit
Drain-Source Voltage	$V_{DS}$	-20	V
Gate-Source Voltage	$V_{GS}$	±8	V
Continuous Drain Current	$I_D$	-2.3	A
Pulsed Drain Current (t=300μs)	$I_{DM}$	-10	A
Power Dissipation	$P_D$	1.5	W
Thermal Resistance from Junction to Ambient	$R_{\theta JA}$	83.3	°C/W
Junction Temperature	$T_J$	150	°C
Storage Temperature	$T_{STG}$	-55~ +150	°C

**MOSFET ELECTRICAL CHARACTERISTICS(T<sub>a</sub>=25°C unless otherwise noted)**

Parameter	Symbol	Test Condition	Min	Type	Max	Unit
<b>Static Characteristics</b>						
Drain-source breakdown voltage	V <sub>(BR)DSS</sub>	V <sub>GS</sub> = 0V, I <sub>D</sub> = -250μA	-20			V
Zero gate voltage drain current	I <sub>DSS</sub>	V <sub>DS</sub> = -20V, V <sub>GS</sub> = 0V			-1	μA
Gate-body leakage current	I <sub>GSS</sub>	V <sub>GS</sub> = ±8V, V <sub>DS</sub> = 0V			±100	nA
Gate threshold voltage	V <sub>GS(th)</sub>	V <sub>DS</sub> = V <sub>GS</sub> , I <sub>D</sub> = -250μA	-0.4	-0.7	-1	V
Drain-source on-resistance <sup>a</sup>	R <sub>DS(on)</sub>	V <sub>GS</sub> = -4.5V, I <sub>D</sub> = -3A		70	90	mΩ
		V <sub>GS</sub> = -2.5V, I <sub>D</sub> = -2A		110	140	
Forward tranconductance <sup>a</sup>	g <sub>FS</sub>	V <sub>DS</sub> = -5V, I <sub>D</sub> = -2A	5			S
<b>Dynamic characteristics<sup>b</sup></b>						
Input Capacitance	C <sub>iss</sub>	V <sub>DS</sub> = -10V, V <sub>GS</sub> = 0V, f = 1MHz		405		pF
Output Capacitance	C <sub>oss</sub>			75		
Reverse Transfer Capacitance	C <sub>rss</sub>			55		
Gate resistance	R <sub>g</sub>	f = 1MHz		6		Ω
Total Gate Charge	Q <sub>g</sub>	V <sub>DS</sub> = -10V, V <sub>GS</sub> = -2.5V, I <sub>D</sub> = -3A		3.3	12	nC
Gate-Source Charge	Q <sub>gs</sub>			0.7		
Gate-Drain Charge	Q <sub>gd</sub>			1.3		
Turn-on delay time	t <sub>d(on)</sub>	V <sub>DD</sub> = -10V, V <sub>GEN</sub> = -4.5V, I <sub>D</sub> = -1A R <sub>L</sub> = 10Ω, R <sub>GEN</sub> = 1Ω		11		ns
Turn-on rise time	t <sub>r</sub>			35		
Turn-off delay time	t <sub>d(off)</sub>			30		
Turn-off fall time	t <sub>f</sub>			10		
<b>Source-Drain Diode characteristics</b>						
Diode forward current	I <sub>S</sub>	T <sub>C</sub> = 25°C			-2.3	A
Diode pulsed forward current <sup>a</sup>	I <sub>SM</sub>				-10	A
Diode Forward voltage	V <sub>DS</sub>	V <sub>GS</sub> = 0V, I <sub>S</sub> = -1.3A			1.2	V

Notes :

a. Pulse Test : Pulse Width &lt; 300μs, Duty Cycle ≤ 2%.

b. Guaranteed by design, not subject to production testing.

Typical Electrical and Thermal Characteristics

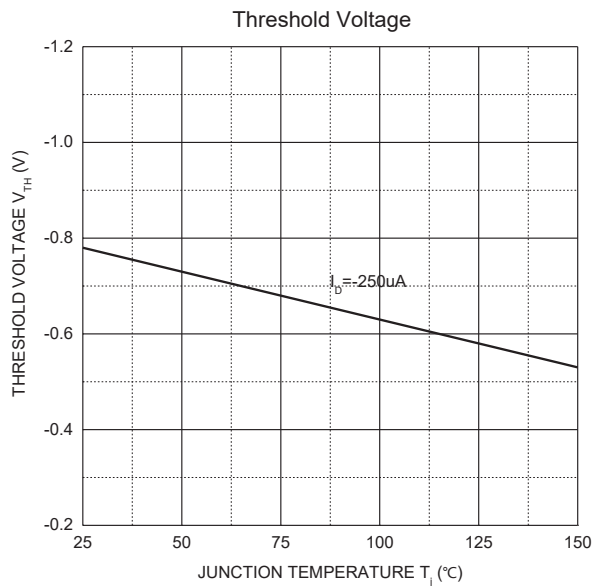
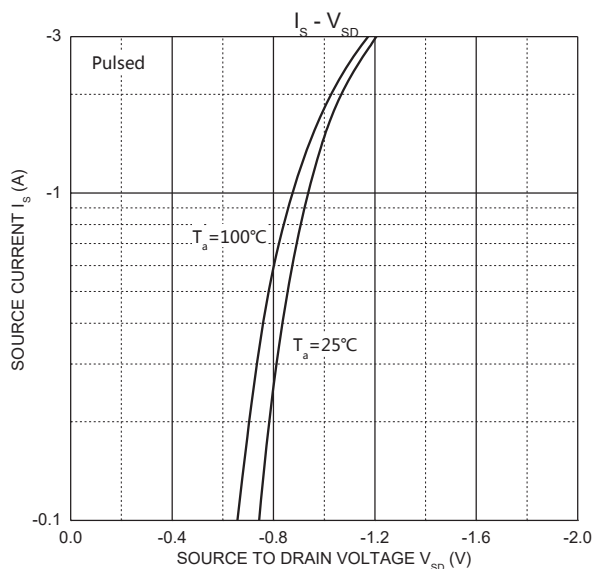
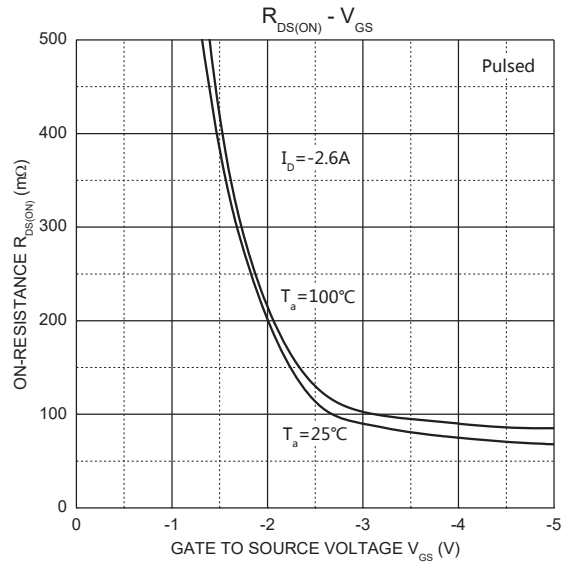
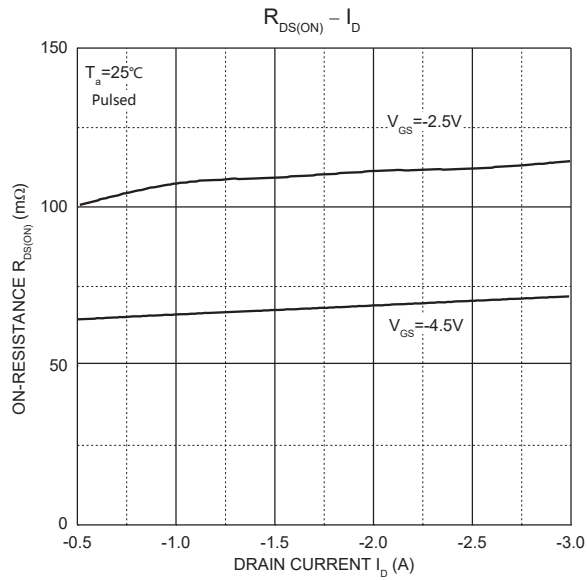
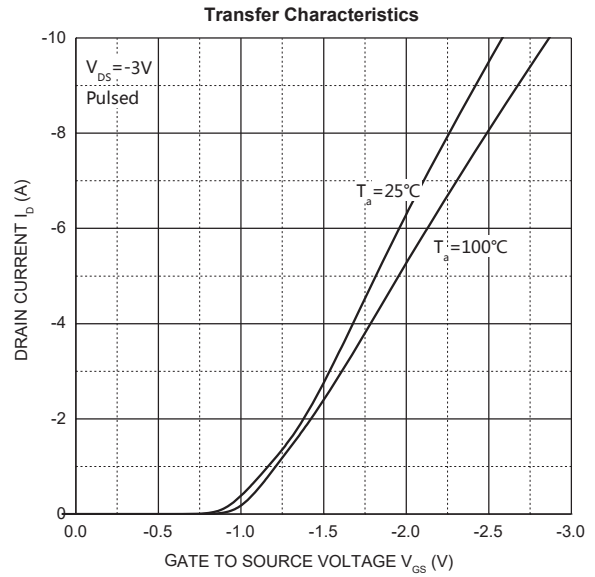
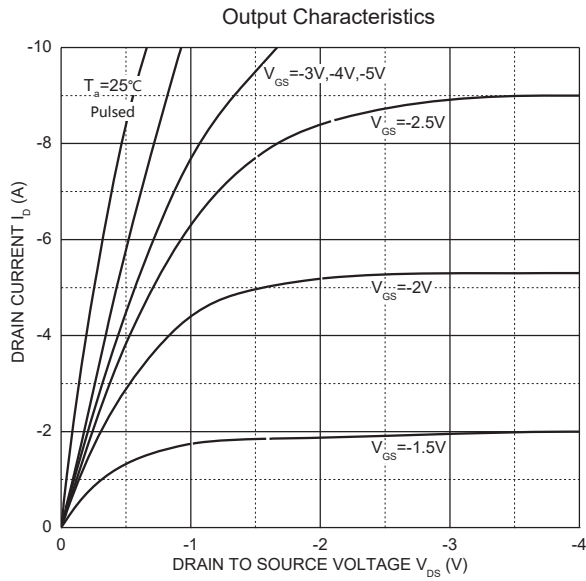

SOT-23 Package Information

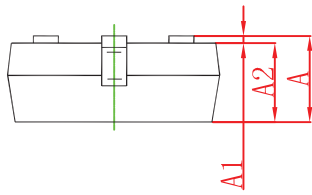
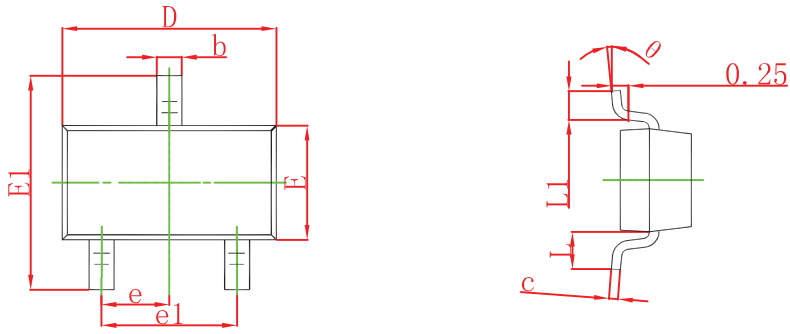

Symbol	Dimensions In Millimeters		Dimensions In Inches	
	Min	Max	Min	Max
A	0.900	1.150	0.035	0.045
A1	0.000	0.100	0.000	0.004
A2	0.900	1.050	0.035	0.041
b	0.300	0.500	0.012	0.020
c	0.080	0.150	0.003	0.006
D	2.800	3.000	0.110	0.118
E	1.200	1.400	0.047	0.055
E1	2.250	2.550	0.089	0.100
e	0.950 TYP		0.037 TYP	
e1	1.800	2.000	0.071	0.079
L	0.550 REF		0.022 REF	
L1	0.300	0.500	0.012	0.020
θ	0°	8°	0°	8°

SOT-23 Tape and Reel

## SOT-23 Tape and reel

### SOT-23 Embossed Carrier Tape

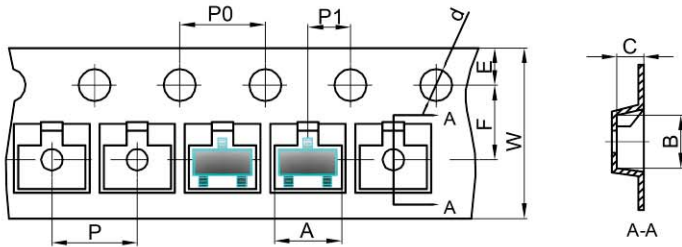

Dimensions are in millimeter										
Pkg type	A	B	C	d	E	F	P0	P	P1	W
SOT-23	3.15	2.77	1.22	Ø1.50	1.75	3.50	4.00	4.00	2.00	8.00

### SOT-23 Tape Leader and Trailer

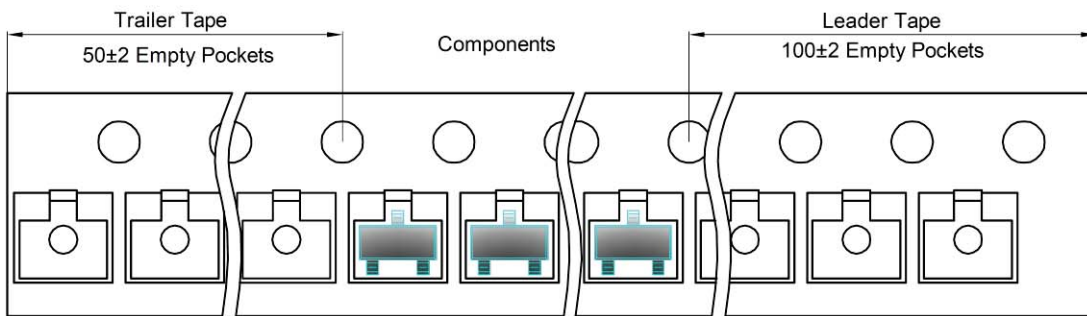

### SOT-23 Reel

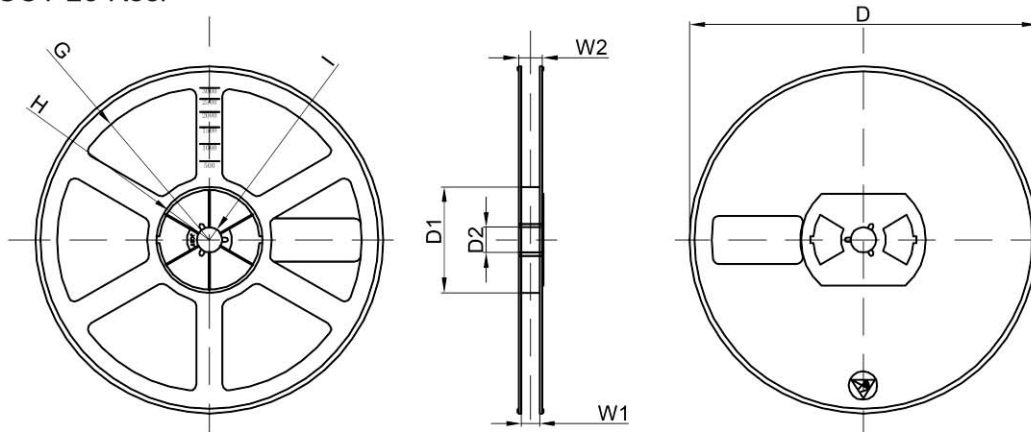

Dimensions are in millimeter								
Reel Option	D	D1	D2	G	H	I	W1	W2
7" Dia	Ø178.00	54.40	13.00	R78.00	R25.60	R6.50	9.50	12.30

REEL	Reel Size	Box	Box Size(mm)	Carton	Carton Size(mm)	G.W.(kg)
3000 pcs	7 inch	30,000 pcs	203×203×195	120,000 pcs	438×438×220	