

SuperTransistor – V_{CBO} -40V, I_c -200mA SOT-23 Plastic-Encapsulate PNP Transistors

1. Features

- Complementary to MMBT3904
- Power dissipation of 200mW
- High stability and high reliability

2. Mechanical Data

- SOT-23 Small Outline Plastic Package
- Epoxy UL: 94V-0
- Mounting Position: Any

3. Pin configuration

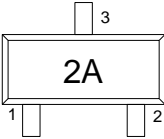
Pin	Function	Outline
1	Base	
2	Emitter	
3	Collector	

4. Specification

Absolute Maximum Rating & Thermal Characteristics

Ratings at 25 °C ambient temperature unless otherwise specified.

Parameters	Symbol	Value	Unit
Collector-Base Voltage	V_{CBO}	-40	V
Collector-Emitter Voltage	V_{CEO}	-40	V
Emitter-Base Voltage	V_{EBO}	-5	V
Collector Current-Continuous	I_c	-200	mA
Collector Power Dissipation	P_c	200	mW
Junction Temperature	T_j	150	°C
Storage Temperature	T_{STG}	-55~150	°C
Thermal resistance From junction to ambient	$R_{\theta JA}$	625	°C/W

Electrical Characteristics(At TA = 25°C unless otherwise specified)

Parameters	Symbols	Test Condition	Limits			
			Min	Typ	Max	Unit
Collector-base breakdown voltage	$V_{(BR)CBO}$	$I_C=-10\mu A, I_E=0$	-40			V
Collector-emitter breakdown voltage	$V_{(BR)CEO}$	$I_C=-1mA, I_B=0$	-40			V
Emitter-base breakdown voltage	$V_{(BR)EBO}$	$I_E=-10\mu A, I_C=0$	-5			V
Collector cut-off current	I_{CEX}	$V_{CE}=-30V, V_{EB(off)}=-3V$			-100	nA
	I_{CBO}	$V_{CB}=-40V, I_E=0$			-50	
Emitter cut-off current	I_{EBO}	$V_{EB}=-5V, I_C=0$			-100	nA
DC current gain	h_{FE1}	$V_{CE}=-1V, I_C=-10mA$	100		300	
	h_{FE2}	$V_{CE}=-1V, I_C=-50mA$	60			
	h_{FE3}	$V_{CE}=-1V, I_C=-100mA$	30			
Collector-emitter saturation voltage	$V_{CE(sat)}$	$I_C=-50mA, I_B=-5mA$			-0.30	V
Base -emitter saturation voltage	$V_{BE(sat)}$	$I_C=-50mA, I_B=-5mA$			-0.95	V
Transition frequency	f_T	$V_{CE}=-20V, I_C=-10mA,$ $f=100MHz$	300			MHz
Delay time	t_d	$V_{CC}=-3V, V_{BE(off)}=-0.5V,$ $I_C=-10mA, I_{B1}=-1mA$			35	ns
Rise time	t_r	$V_{CC}=-3V, V_{BE(off)}=-0.5V,$ $I_C=-10mA, I_{B1}=-1mA$			35	ns
Storage time	t_s	$V_{CC}=-3V, I_C=-10mA,$ $I_{B1}=I_{B2}=-1mA$			225	ns
Fall time	t_f	$V_{CC}=-3V, I_C=-10mA,$ $I_{B1}=I_{B2}=-1mA$			75	ns

Classification of h_{FE}

h_{FE}	100~300	
Rank	L	H
Range	100~200	200~300

5. Typical Characteristic

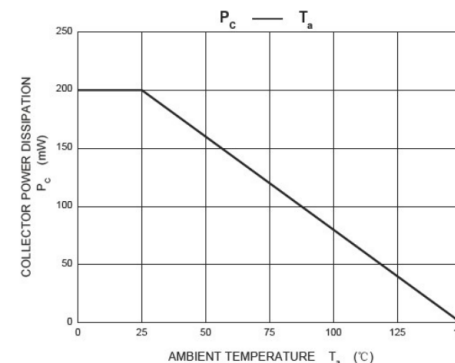
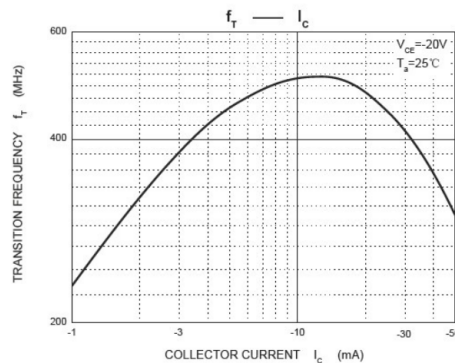
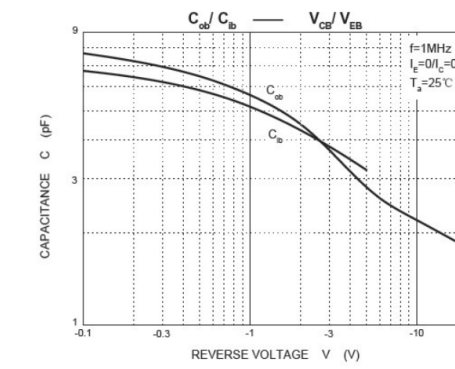
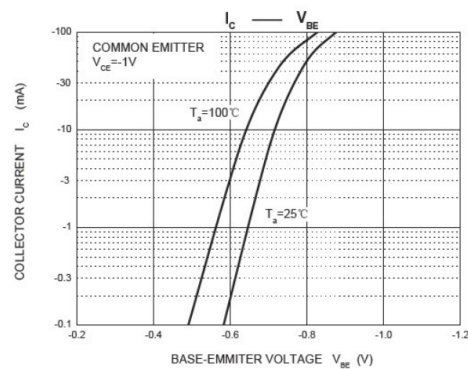
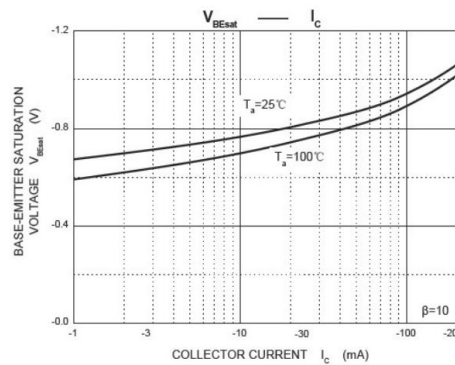
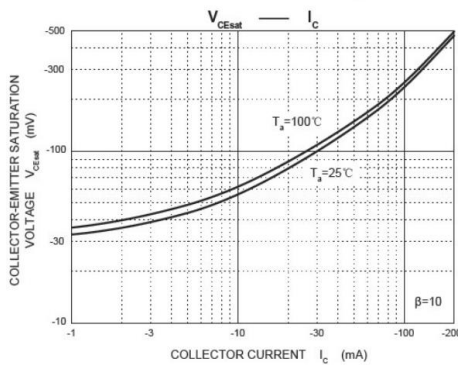
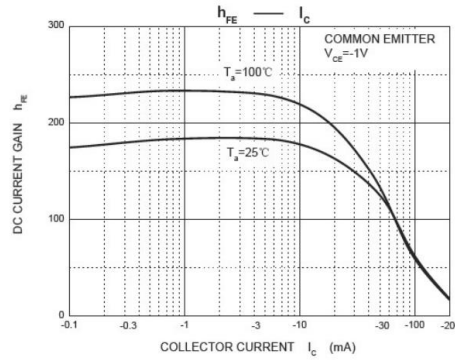
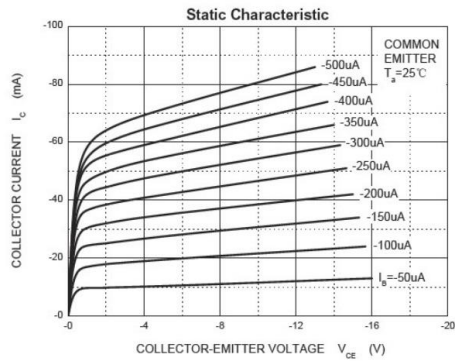

6. Dimension and Patterns (SOT-23)

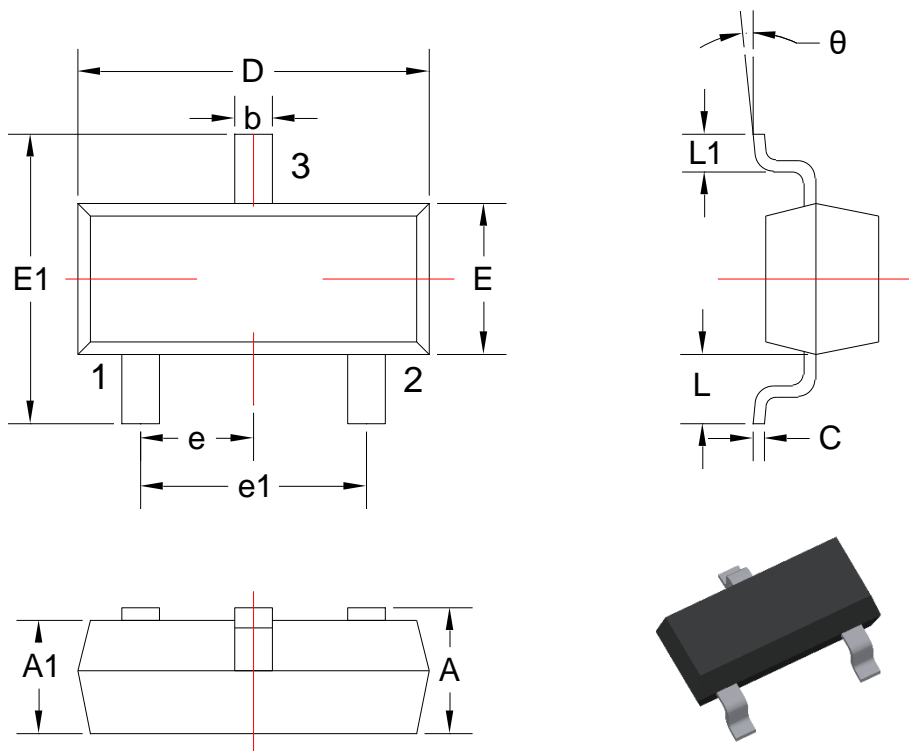

Units: mm

Symbol	Dimensions		Symbol	Dimensions	
	Min.	Max.		Min.	Max.
A	0.900	1.150	E1	2.250	2.550
A1	0.900	1.050	e	0.950TYP	
b	0.300	0.500	e1	1.800	2.000
c	0.080	0.150	L	0.550REF	
D	2.800	3.00	L1	0.300	0.500
E	1.200	1.400	θ	0°	8°

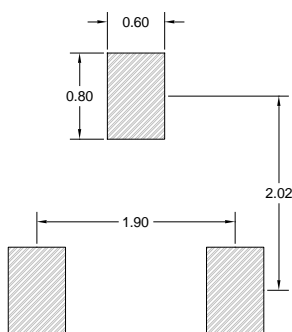

Note:

1. Controlling dimension: in millimeters
2. General tolerance: ±0.05mm
3. The pad layout is for reference only
4. Unit: mm

DISCLAIMER

ELECSUPER PROVIDES TECHNICAL AND RELIABILITY DATA (INCLUDING DATASHEETS), DESIGN RESOURCES (INCLUDING REFERENCE DESIGNS), APPLICATION OR OTHER DESIGN ADVICE, SAFETY INFORMATION, AND OTHER RESOURCES "AS IS" AND WITH ALL FAULTS, AND DISCLAIMS ALL WARRANTIES, EXPRESS AND IMPLIED, INCLUDING WITHOUT LIMITATION ANY IMPLIED WARRANTIES OF MERCHANTABILITY, FITNESS FOR A PARTICULAR PURPOSE OR NON-INFRINGEMENT OF THIRD PARTY INTELLECTUAL PROPERTY RIGHTS.

These resources are intended for skilled developers designing with ElecSuper products. You are solely responsible for

- (1) selecting the appropriate ElecSuper products for your application;
- (2) designing, validating and testing your application;
- (3) ensuring your application meets applicable standards, and any other safety, security, or other requirements.

These resources are subject to change without notice. ElecSuper grants you permission to use these resources only for development of an application that uses the ElecSuper products described in the resource. Other reproduction and display of these resources are prohibited. No license is granted to any other ElecSuper intellectual property right or to any third party intellectual property right. ElecSuper disclaims responsibility for, and you will fully indemnify ElecSuper and its representatives against, any claims, damages, costs, losses, and liabilities arising out of your use of these resources. ElecSuper's products are provided subject to ElecSuper's Terms of Sale or other applicable terms available either on www.elecsuper.com or provided in conjunction with such ElecSuper products. ElecSuper's provision of these resources does not expand or otherwise alter ElecSuper's applicable warranties or warranty disclaimers for ElecSuper products.