

General Description

SN74LVC1G00 is a 2 - input and non-gate integrated circuit, which can realize the mathematical logic operation of $Y=\overline{A+B}$ and $Y=\overline{A}\cdot\overline{B}$. Advanced CMOS process design, with low power consumption and high output driving capability, the power supply voltage V_{CC} between 1.65V and 5.5V chip can work normally. 74LVC1G00 has a variety of small encapsulation shapes, which can be widely used in high-end precision instruments, miniaturized and low-power hand-held devices, as well as artificial intelligence and other fields.

Features

- Low input current.
- Low static power consumption. $I_{cc}=0.1\mu A$.
- High output drive. $V_{CC}=4.5V$.
- Wide operating voltage range. 1.65V-5.5V
- Packaging form: DBV/DRL/YZP/DCK DRP/DSF/DPW

Applications

- Portable audio interface
- Blu-ray players and home theaters
- Solid state drives
- Digital TV
- Wireless headphones, smart watches, etc
- Smart wearable Devices

Pinning and Package

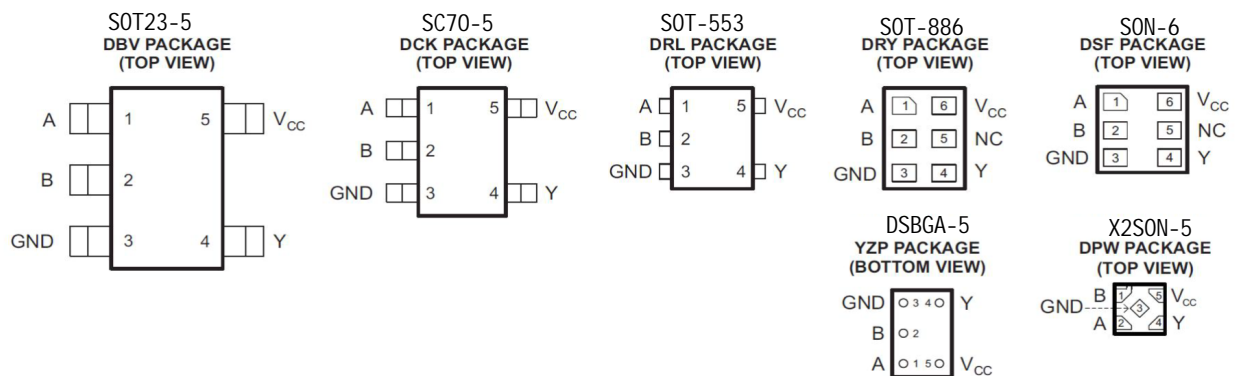

Pin Functions

NAME	PIN			DESCRIPTION
	DBV, DCK, DRL, YZP	DRY, DSF	DPW	
A	1	1	2	Input
B	2	2	1	Input
GND	3	3	3	Ground
Y	4	4	4	Output
V_{CC}	5	6	5	Power pin
NC		5		Not connected

Absolute Maximum Ratings

over operating free-air temperature range (unless otherwise noted)

		MIN	MAX	UNIT
V_{CC}	Supply voltage range	-0.5	6.5	V
V_I	Input voltage range	-0.5	6.5	V
V_O	Voltage range applied to any output in the high-impedance or power-off state ⁽²⁾	-0.5	6.5	V
V_O	Voltage range applied to any output in the high or low state ⁽²⁾⁽³⁾	-0.5	$V_{CC} + 0.5$	V
I_{IK}	Input clamp current	$V_I < 0$	-50	mA
I_{OK}	Output clamp current	$V_O < 0$	-50	mA
I_O	Continuous output current		± 50	mA
	Continuous current through V_{CC} or GND		± 100	mA

- (1) Stresses beyond those listed under *Absolute Maximum Ratings* may cause permanent damage to the device. These are stress ratings only, and functional operation of the device at these or any other conditions beyond those indicated under *Recommended Operating Conditions* is not implied. Exposure to absolute-maximum-rated conditions for extended periods may affect device reliability.
- (2) The input and output negative-voltage ratings may be exceeded if the input and output current ratings are observed.
- (3) The value of V_{CC} is provided in the *Recommended Operating Conditions* table.

Functional Block Diagram



Device Functional Modes

Inputs		Output
A	B	Y
L	L	H
L	H	H
H	L	H
H	H	L

Recommended Operating Conditions

			MIN	MAX	UNIT
V_{CC}	Supply voltage	Operating	1.65	5.5	V
		Data retention only	1.5		
V_{IH}	High-level input voltage	$V_{CC} = 1.65\text{ V to }1.95\text{ V}$	$0.65 \times V_{CC}$		V
		$V_{CC} = 2.3\text{ V to }2.7\text{ V}$	1.7		
		$V_{CC} = 3\text{ V to }3.6\text{ V}$	2		
		$V_{CC} = 4.5\text{ V to }5.5\text{ V}$	$0.7 \times V_{CC}$		
V_{IL}	Low-level input voltage	$V_{CC} = 1.65\text{ V to }1.95\text{ V}$		$0.35 \times V_{CC}$	V
		$V_{CC} = 2.3\text{ V to }2.7\text{ V}$		0.7	
		$V_{CC} = 3\text{ V to }3.6\text{ V}$		0.8	
		$V_{CC} = 4.5\text{ V to }5.5\text{ V}$		$0.3 \times V_{CC}$	
V_I	Input voltage		0	5.5	V
V_O	Output voltage		0	V_{CC}	V
I_{OH}	High-level output current	$V_{CC} = 1.65\text{ V}$		-4	mA
		$V_{CC} = 2.3\text{ V}$		-8	
		$V_{CC} = 3\text{ V}$		-16	
		$V_{CC} = 4.5\text{ V}$		-32	
I_{OL}	Low-level output current	$V_{CC} = 1.65\text{ V}$		4	mA
		$V_{CC} = 2.3\text{ V}$		8	
		$V_{CC} = 3\text{ V}$		16	
		$V_{CC} = 4.5\text{ V}$		32	

Electrical Characteristics

over recommended operating free-air temperature range (unless otherwise noted)

PARAMETER		TEST CONDITIONS	V _{CC}	TYP	MAX	UNIT
V _{OH}		I _{OH} = -100uA	1.65V~5.5V	1.64	-	V
		I _{OH} = -4 mA	1.65V	1.47	-	
		I _{OH} = -8 mA	2.3V	2.15	-	
		I _{OH} = -16 mA	3V	2.73	-	
		I _{OH} = -32 mA	4.5V	4.0	-	
V _{OL}		I _{OH} = 100uA	1.65V~5.5V	0.01	-	V
		I _{OH} = 4 mA	1.65V	0.11	-	
		I _{OH} = 8 mA	2.3V	0.11	-	
		I _{OH} = 16 mA	3V	0.2	-	
		I _{OH} = 32 mA	4.5V	0.35	-	
I _I	A	V _I = 5.5V or GND	0~5.5V	0.01	±5	uA
	B			0.01	±5	
I _{OFF}	V _I	V _I = 5.5V	0	0.01	±10	uA
	V _O	V _O = 5.5V	0	0.01	±10	
I _{CC}		V _I = 5.5V, I _O = 0	1.65V~5.5V	0.01	10	uA
		V _I = GND, I _O = 0		0.01	10	
ΔI _{CC}		A = V _{CC} - 0.6V	3V~5.5V	25	-	uA
		B = V _{CC} or GND				
		B = V _{CC} - 0.6V A = V _{CC} or GND		25	-	

 (1) All typical values are at V_{CC} = 3.3 V, T_A = 25°C.

Switching Characteristics, C_L = 15 pF

over recommended operating free-air temperature range (unless otherwise noted) (see

PARAMETER	FROM (INPUT)	TO (OUTPUT)	-40°C to 85°C								UNIT
			V _{CC} = 1.8 V ± 0.15 V		V _{CC} = 2.5 V ± 0.2 V		V _{CC} = 3.3 V ± 0.3 V		V _{CC} = 5 V ± 0.5 V		
			MIN	MAX	MIN	MAX	MIN	MAX	MIN	MAX	
t _{pd}	A or B	Y	1.5	7.2	0.7	4.4	0.8	3.6	0.8	3.4	ns

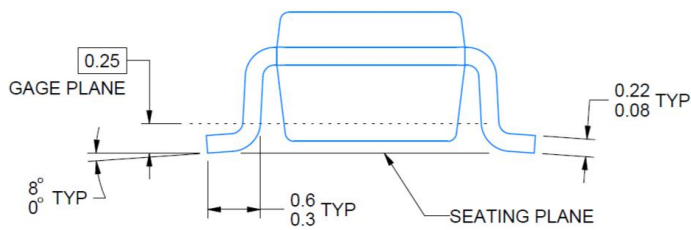
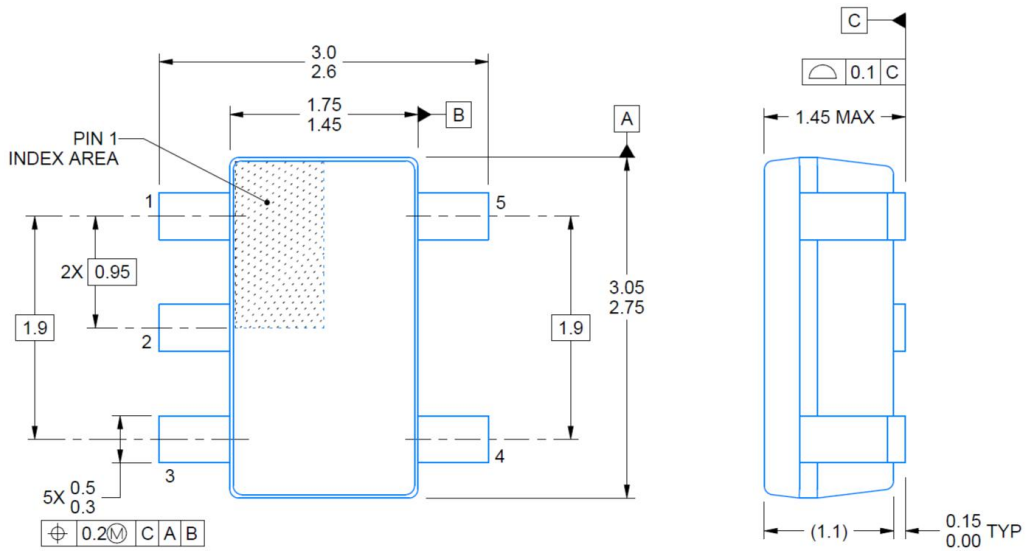
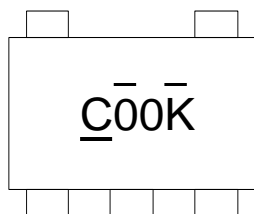
Package Outline
DBV (SOT23-5)

Marking

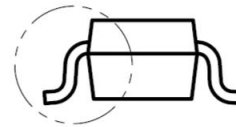
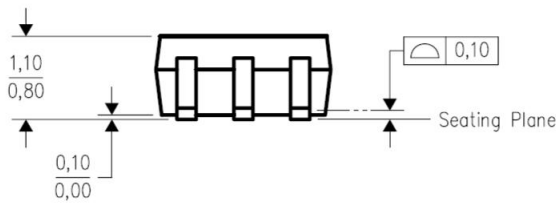
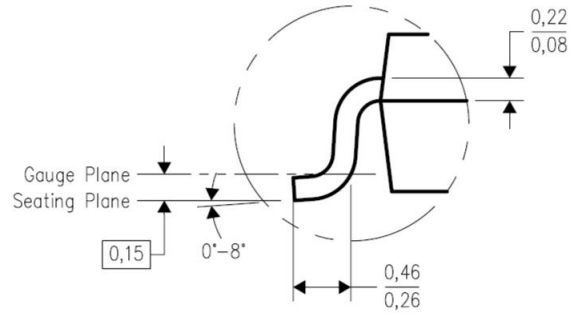
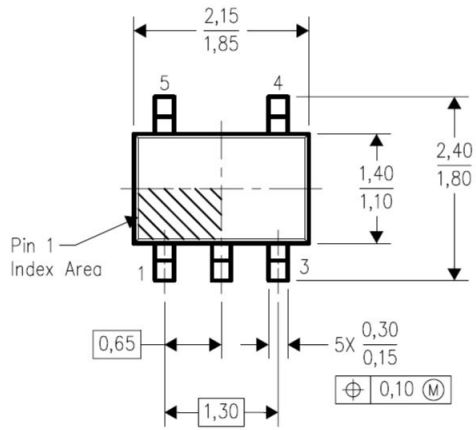
DCK (SC70-5)

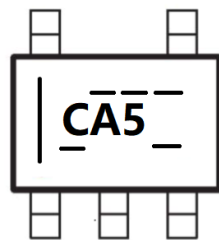

Marking



DRL (SOT-553)

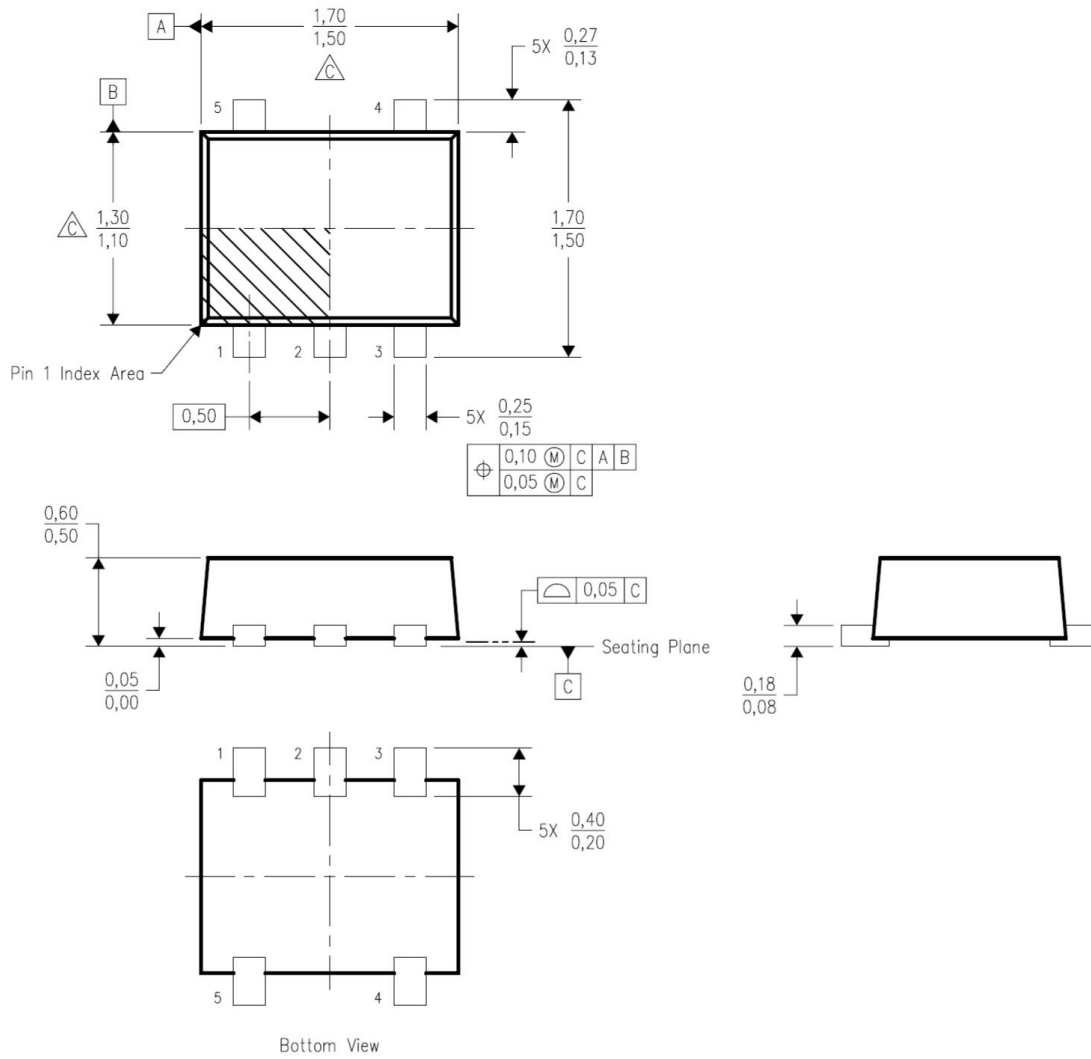

DRY (SOT-886)

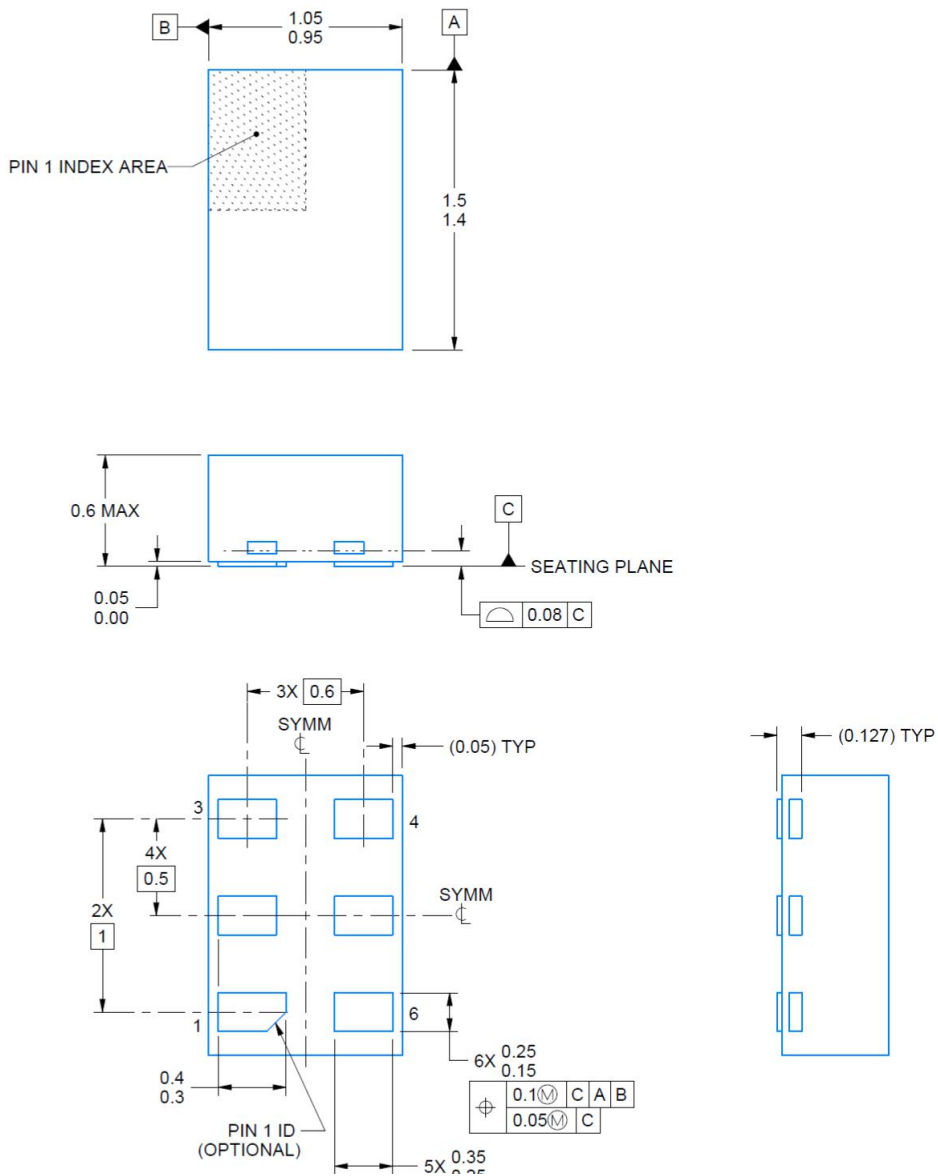

DSF (SON-6)

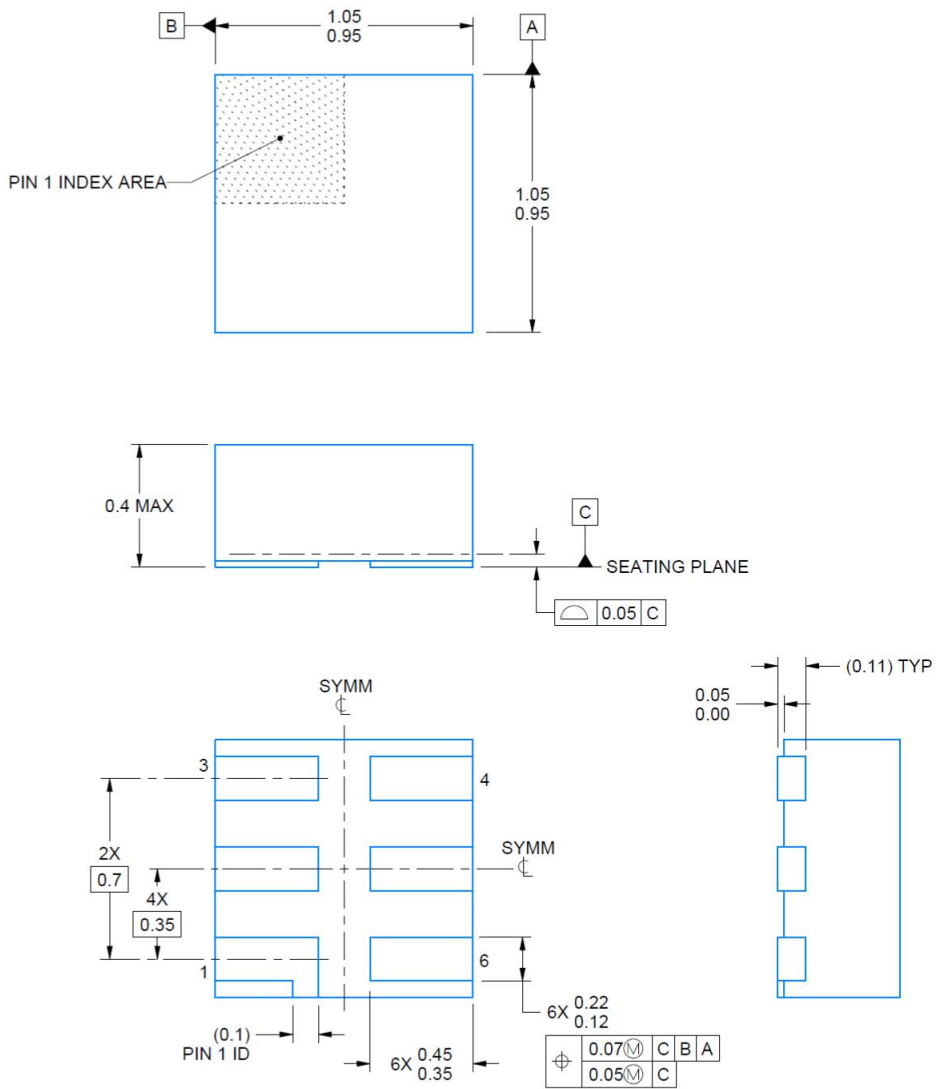

YZP (DSBGA-5)

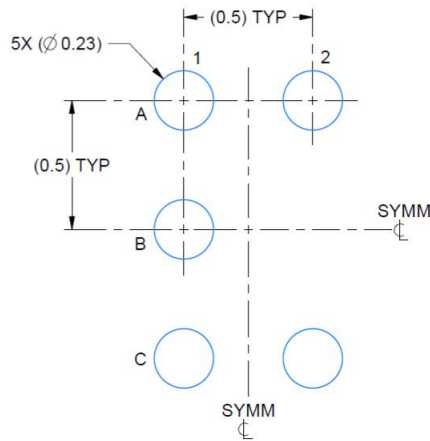

LAND PATTERN EXAMPLE
SCALE:40X



DPW (X2SON-5)

