



方成电子（东莞）有限公司
SPECIFICATION FOR APPROVAL

CUSTOMER:
Part Number : SMD Common Line Filter
CUSTOMER Number: 贴片共模电感
CUSTOMER Part :
Fangcheng part : FC-SLF1212T-25mH-2.5A-LF
DATE: 2022-11-03
REV: 01



Confidential

made in fangcheng:

CUSTOMER APPROD:

prepad	checd	Approd
黄敏	刘凡	陈丽萍

prepad	checd	Approd

THE INFORMATION CONTAINED IN THIS DOCUMENT IS OF A PROPRIETARY NATURE AND IS INTENDED TO BE KEPT CONFIDENTIAL BETWEEN THE SENDER AND THE INTENDED RECIPIENT. IT MAY NOT BE REPRODUCED OR USED WITHOUT EXPRESS WRITTEN PERMISSION OF FC TECHNOLOGIES, OR FC



方成电子（东莞）有限公司

Tel: +86 0769-82988010

Fax: +86 0769-82988065

E-mail: yhl@fangchengcoils.com

URL: www.fangchengcoils.com

Address: Building 3, Jinmei Technology Park, No.16 Huanchang West Road, Changping Town,
Dongguan City

Fangcheng Electronics (China-Taiwan) Office

Address: No. 31, MRT Road, Zhonghe District, New Taipei City

Tel: +8869-983491379



Customer:

made : 方成电子(东莞)有限公司

Part Number: FC-SLF1212T-25mH-2.5A-LF

Page: 2 ----- 8

Description of Revision

REV	Description of Revision	DATE	Prepad	Notes
01	Initial Release	2022-11-3	黄敏	

Prepad 黄敏	Checked 刘凡	Approved 陈丽萍
--------------	---------------	-----------------

Customer:

made : 方成电子(东莞)有限公司

Part Number: FC-SLF1212T-25mH-2.5A-LF

Page: 3 ----- 8

Notice of Use

For the parameters not prescribed in the *Specification for Approval*, please refer to the following standards or the relative industry standards.

1. Product in packing storage condition : temperature 540, RH70%.
 2. A storage of - F C -Electronic products for longer than 12 months is not recommended, Within other effects, the terminals may suffer degradation, resulting in bad solderability. Therefore, all products shall be used within the period of 12 months based on the day of shipment.
 3. Do not keep products in unsuitable storage conditions, such as areas susceptible to high temperatures, high humidity, dust or corrosion.
 - 4 Always handle products with care.
 - 5 Don't touch electrodes directly with bare hands as oil secretions may inhibit soldering. Always ensure optimum conditions for soldering.
 - 6 When this product will be used on a similar or new project to the original one, sometimes it might be unable to satisfy the specifications due to different condition of usage.
 - 7 This inductor itself does not have any protective function in abnormal condition, such as overload, short-circuit, open-circuit conditions, etc. Therefore, it shall be confirmed that there is no risk of smoke, fire, dielectric withstand voltage, insulation resistance, etc., or use in abnormal conditions protective devices or protection circuit in the end product.
 - 8 Hi-Pot test with higher voltage than spec value will damage insulating material and shorten its life.
- IPC 020D Joint Industry standard
IEC1007 《Transformer and inductors for use in electronic and telecommunication equipment—Measuring methods and test procedures》
(ROHS or other environmental request)



Prepad <p style="text-align: center;">黄敏</p>	Checd <p style="text-align: center;">刘凡</p>	Approd <p style="text-align: center;">陈丽萍</p>
---	--	--

1. Appearance and Dimensions(mm)

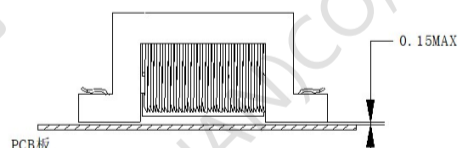
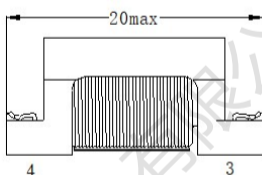
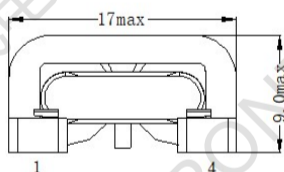
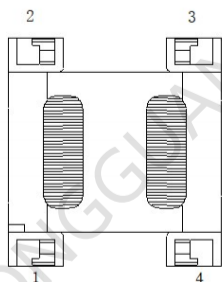
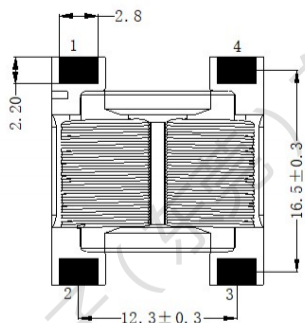

产品与PCB板的平整度为0.15最大
The flatness of product and PCB board is 0.15 Max

2. Schematic :

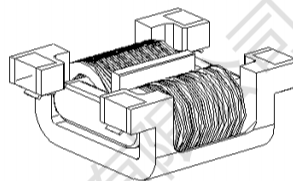
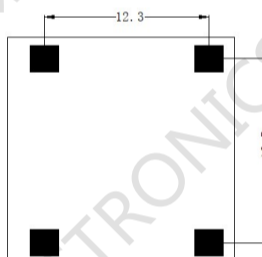
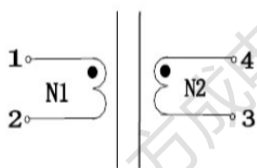

3. Electrical Characteristics :

TEST CONDITION: TEMPERATURE AT 25°C, HUMIDITY AT 65±5% RH / 测试条件: 温度 25°C, 湿度 65±5%RH				
NO 序号	PARAMETER 参数	TERMINAL 脚位	SPCIFICATION 规格	TEST INSTRUMENTS 测试设备
1	INDUCTANCE 电感	L=(1-2) (4-3)	25mH/typ/20mH/min	1.0KHz,0.25V 内阻 30Ω CHROMA 3250 or EQUAL
2	工作电流 I=A	I=(1-2) (4-3)	2.5A	1.0KHz,0.25V 320X CHROMA 3250 or EQUAL
3	DCR 直流铜阻	R= (1-2) (4-3)	0.25 Ω Max	GKT2511 25°C
4	高压测试	COIL-CORE	AC 1500V	CH19503
5	INSULATION RESISTANCE 绝缘电阻	COIL-CORE	500VDC/100M Ω MIN	CHROMA 19053 DC500V

3.1 严格按照工艺图绕线;

Prepad 黄敏	Checd 刘凡	Approd 陈丽萍
------------------	-----------------	-------------------

Customer:

made : 方成电子(东莞)有限公司

Part Number: FC-SLF1212T-25mH-2.5A-LF

Page: 5 ----- 8

4. Reliability and test condition:

Test item	test condition	Remark
Cold Operating Test	GB2423. 1 Ad	
Heat Operating Test	GB2423. 2 Bd	
Cold Storage Test	GB2423. 1 Ab	
Heat Storage Test	GB2423. 2 Bb	
Steady Damp Heat Test	GB2423. 3 Cb	
Circular Damp Heat Test	GB2423. 4 Db	
Temperature Cycling Test	GB2423. 22 Nb	
Temperature Shock Test	GB2423. 22 Na	
Vibration Test	GB2423. 10~15 Fc, Fdb	
Mechanical Shock Test(Bump)	GB2423. 5 Eb	
Free Fall Test	GB2423. 8 Ed	
Solderability	GJB360A-96	
High Temperature Step Stress Test	Enhancement Test Specifications	
Low Temperature Step Stress Test		
High-speed Thermal Cycling		
Limit Vibration		
Composite Stress		
Highly-Accelerated Temperature and Humidity Stress Test(HAST) (



Prepad 黄敏	Checked 刘凡	Approved 陈丽萍
--------------	---------------	-----------------

5. Soldering Specification:

5.1 Reflow Profile for Components.

Peak Temp : 260°C max.

Max time above 230°C : 50sec max.

Max time above 200°C : 70sec max.

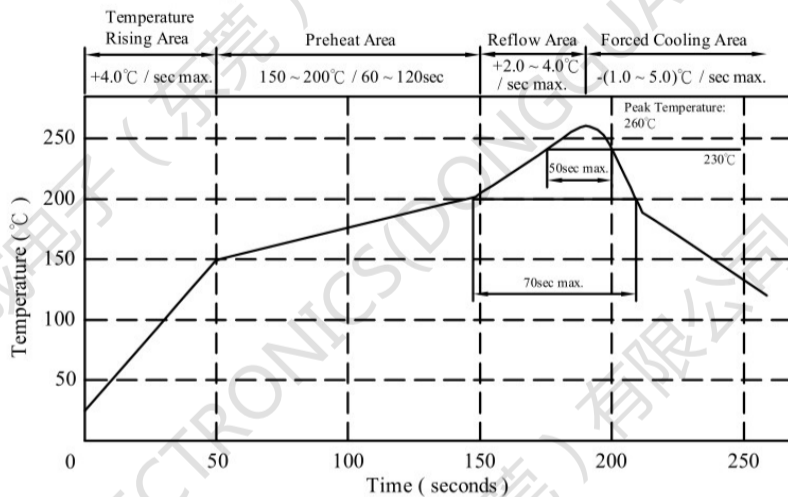

5.2 高温耐热性:

在 260°C 的熔融钎料中，停留时间不少于 10 秒，无质量问题。

5.3 返修温度和时间:

温度: 350°C; 时间: 不少于 5 秒。

5.4 焊接次数:

元器件能承受的焊接次数不少于 5 次。

6.1 包装:

- 1) 包装箱上应标明产品型号、名称、数量、出厂日期、承制方名称及出厂检验章;
- 2) 货物运达客户方后，包装箱封条应完好，箱体无破损、开裂等现象;
- 3) 电感用木箱或其他材料包装，方便拆卸，四周用软性材料填充;

6.2 外观:

- 1) 产品应有合格证和耐擦防水洗标签，应注明型号、规格;
- 2) 产品外观整洁，应无破损、划伤;

6.3 检验:

- 1) 产品生产中必须全数进行电气性能，抗电强度检测；箱内应有 100% 电气性能合格保证书或检测报告；
- 2) 产品出货前按批次，必须根据承认书按国家行业标准进行抽样检验，合格后出具出厂检验报告，记录抽样测试数据，在每批次包装尾箱中放置一份；检验报告须注明 100% 耐压测试合格。注：批次按订单号发货为准

Prepad

黄敏

Checd

刘凡

Approd

陈丽萍